

**HIGHWAY USER REVENUE FUND
FISCAL YEAR 2000
YEAR-END REPORT**



PREPARED BY:

**ARIZONA DEPARTMENT OF TRANSPORTATION
FINANCIAL MANAGEMENT SERVICES
OFFICE OF FINANCIAL PLANNING
AUGUST 2000**

HIGHWAY USER REVENUE FUND EXECUTIVE SUMMARY

The State of Arizona taxes motor fuels and collects fees relating to the registration and operation of motor vehicles, including gasoline and use fuel taxes, motor carrier fees, motor vehicle registration fees, vehicle license taxes (VLT), and other miscellaneous fees. Revenues are deposited in the Arizona Highway User Revenue Fund (HURF) and are then distributed to the cities, towns and counties and to the State Highway Fund. These fees and taxes are the primary source of revenue to the state for highway construction, improvements and other related expenses.

For the first time, total HURF revenue collections exceeded \$1 billion with Fiscal Year (FY) 2000 collections totaling \$1,019.6 million. Total collections for FY 2000 posted an increase of \$36.8 million over FY 1999, a 3.7 percent increase. However, revenues fell short of the \$1,022.7 million forecast by 0.3 percent. All the major revenue categories posted gains over the FY 1999 revenue levels, except use fuel. The use fuel decrease can be attributed to unusual refunds for prior fiscal years. VLT produced the largest gain over FY 1999 levels, posting a 7.5 percent increase.

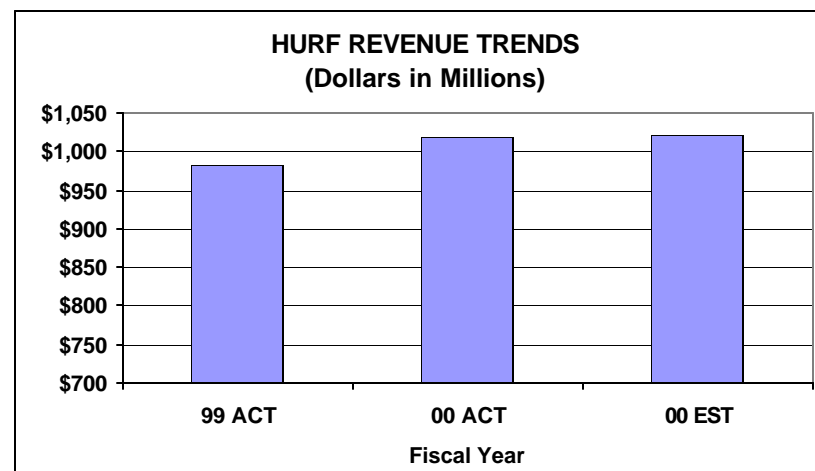

REVENUE TREND ANALYSIS

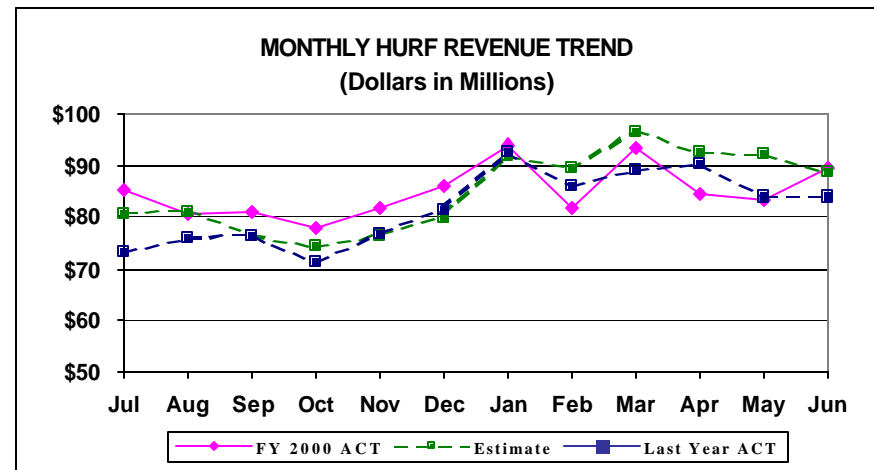
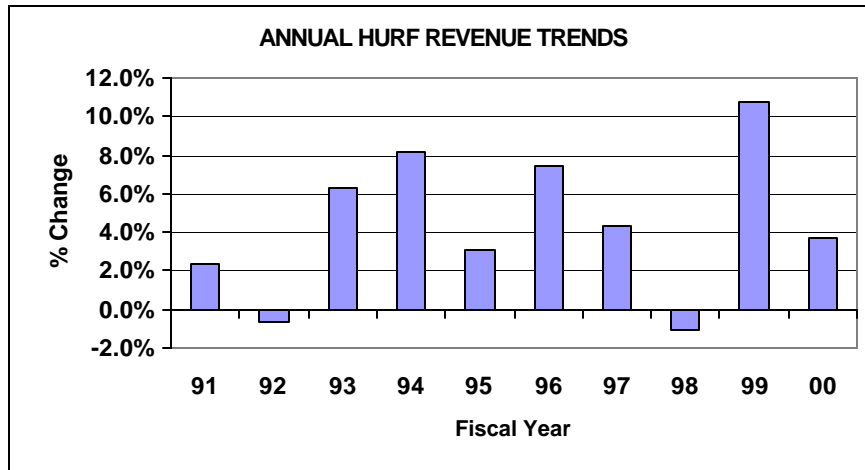

Annual HURF Revenue Trends indicate overall growth year over year with the exception of small setbacks in 92 and 98. Fiscal Year 99 showed dramatic growth due to a good economy and full implementation of 1997 law changes. Fiscal Year 2000 was an unusual year, HURF collections started out strong and ended with a modest gain of 3.7 percent over FY 1999 collections. The lack of growth in the second half of FY 2000 was impacted by higher fuel prices and an unusually high level of fuel refunds for prior years. Overall, the Arizona economy remained strong benefiting from growth in employment, personal income, and population.

The monthly trend continues to show spikes upward for January and March due to increases in registrations. As seen in the Monthly HURF Revenue Trend chart, January through June collections exhibited higher levels of variability due to higher fuel prices and fuel refund issues discussed above.

PERFORMANCE BY CATEGORY

GAS TAX:

Gasoline taxes contributed \$409.1 million in revenues, exceeding FY 1999 collections by 2.9 percent, but fell short of the FY 2000 estimate by 1.0 percent. The gasoline tax is the largest component of HURF collections, at approximately 40.1 percent of total receipts for FY 2000.

Increases in wage and salary employment along with personal income for the first half of this decade have favorably impacted the Arizona economy. However, these economic indicators have shown slower growth since the mid-1990's. The Blue Chip Consensus estimated a 3.8 percent increase in Arizona wage and salary employment and 7.0 percent growth for Arizona personal income for Calendar Year (CY) 1999. Actual figures showed Arizona wage and salary employment higher than estimated with a 4.1 percent growth rate, while Arizona personal income matched the estimate at 7.0 percent. For CY 2000, the Blue Chip estimates are lower with a 3.3 percent estimate for wage and salary employment growth and 6.7 percent for growth in personal income. Estimates for CY 2001 wage and salary employment are 2.9 percent and 6.2 percent for personal income.

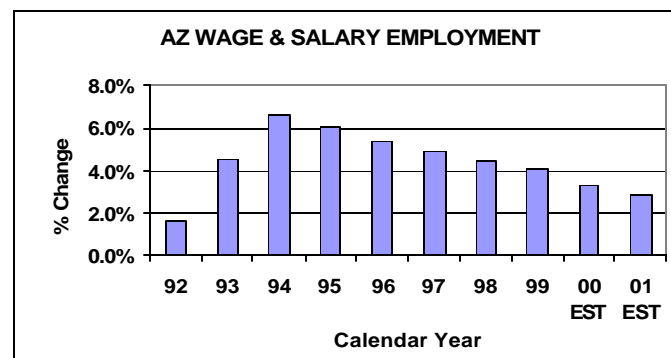
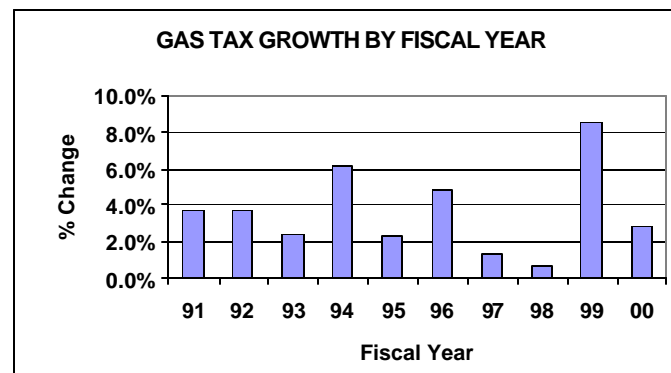

SOURCE: BLUE CHIP CONSENSUS - 6/00

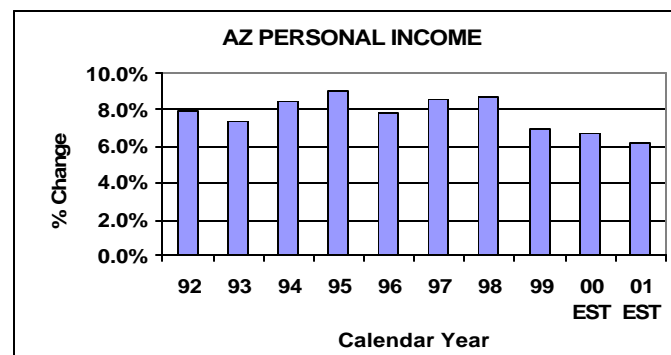

SOURCE: BLUE CHIP CONSENSUS - 6/00

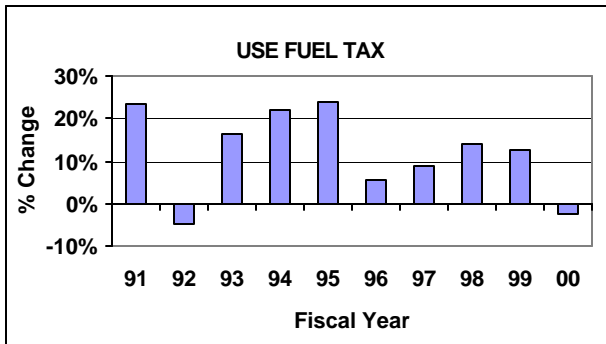

USE FUEL TAX:

Use fuel tax revenues for FY 2000 totaled \$156.6 million, reflecting a decrease of 2.3 percent over last year’s collections of \$160.3 million. The decrease is due to higher fuel prices and approximately \$8.8 million in refunds issued for prior years. Without the refunds, use fuel collections would have ended the fiscal year up 3.2 percent over the FY 1999 revenue level.

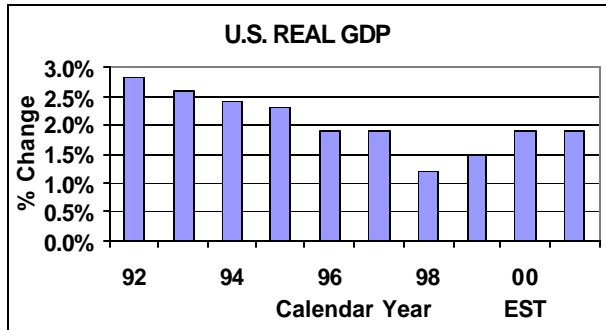

Increased commerce and truck traffic due to the continued strong national economy has contributed to the growth in use fuel tax collections over the past few years. In CY 1999, U.S. Real GDP grew at a rate of 1.5 percent. The Blue Chip Consensus estimates that the U.S. Real GDP will grow at a rate of 1.9 percent during CY 2000 and 2.0 percent during CY 2001.

SOURCE: Blue Chip Consensus - 6/00

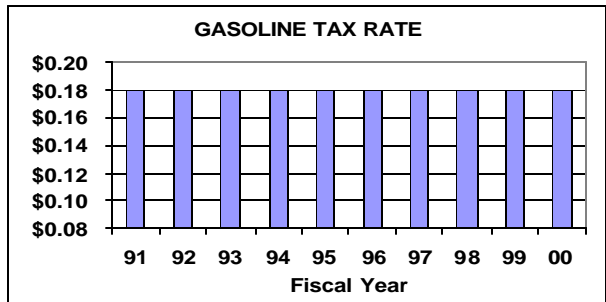

GASOLINE TAX RATE:

The chart to the left shows the gasoline tax rates per gallon in effect at the beginning of each fiscal year. The last tax increase was in FY 1991, bringing the tax rate to its present level of \$.18 per gallon.

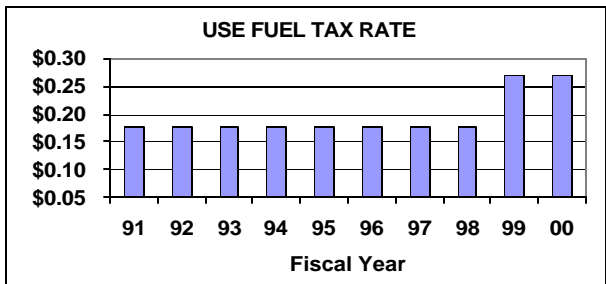

USE FUEL TAX RATE:

The use fuel tax rate per gallon in effect at the beginning of each fiscal year is shown in the chart to the left. The large increase in FY 1999 includes the \$.09 per gallon tax increase imposed on use fuel consumed by “use class” vehicles. This increase replaced the \$.08 per gallon surcharge on use fuel from January 1, 1994 through September 30, 1997, which is not reflected in this chart. The use fuel tax will drop from \$0.27 to \$0.26 July 1, 2000 in accordance with a 1997 legislative requirement.

MOTOR CARRIER FEE:

Motor carrier fee revenues exceeded last year's collections and the estimate with increases of 7.1 and 7.2 percent, respectively. Total motor carrier fee collections were \$36.6 million. The Arizona weight distance tax was repealed effective September 30, 1997 and was replaced with a motor carrier fee paid at the time of registration. A delay in implementation by other states is reflected in reduced revenues in FY 1998, FY 1999 and larger than usual revenues in FY 2000.

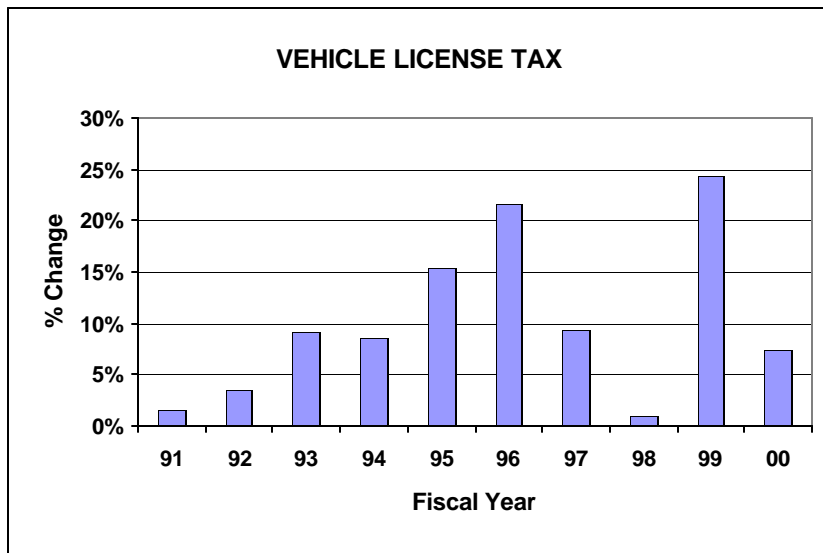
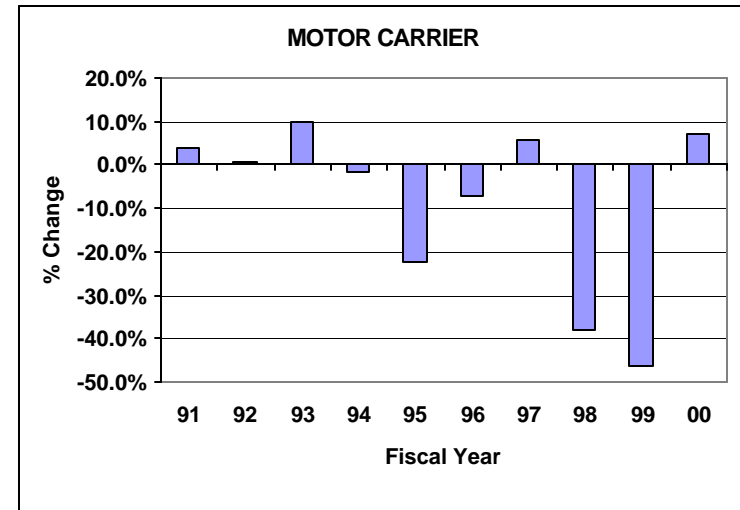

VEHICLE LICENSE TAX:

The HURF portion of VLT revenues totaled \$236.6 million in FY 2000 compared to \$220.1 million in FY 1999, reflecting a 7.5 percent increase. This increase is attributed to a strong economy and high volume sales of new vehicles. HURF VLT collections tracked closely to the estimate with a positive variance of 0.6 percent.

REGISTRATION:

County Registration, Apportioned, and Miscellaneous Registration collections totaled \$140.3 million for FY 2000 resulting in a 6.4 percent increase over FY 1999. When compared to the estimate, total registrations collections had a positive variance of 5.5 percent.

The continued increase in the State's population has contributed to the increase in registration collections, specifically, county registration. Arizona population was 4.8 million in CY 1999, reflecting a 2.8 percent gain over the previous year. It is estimated that Arizona's population will again increase 2.8 percent in CY 2000 and 2.6 percent in CY 2001.

OTHER FEES:

Other Revenues increased 4.2 percent over last year's collections. Revenues for FY 2000 totaled \$40.4 million and were 2.0 percent above the forecast. Other fees consist of title fees, operator licenses, oversize permits, inquiry fees, use fuel permits, investment interest, and other miscellaneous fees. Included in miscellaneous fees are credit card reimbursement fees to third party contractors. Reimbursements increased 90 percent from FY 1999 to FY 2000.

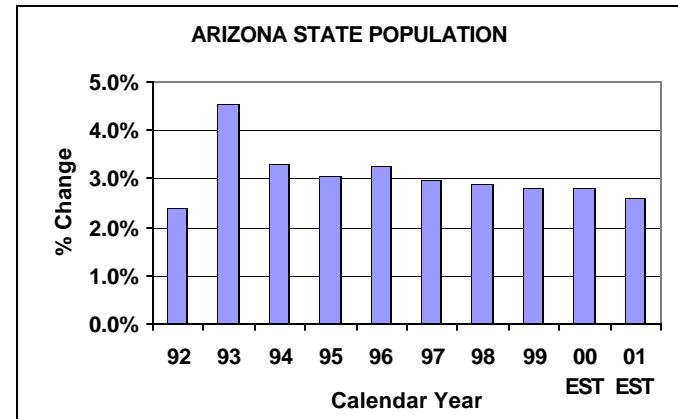
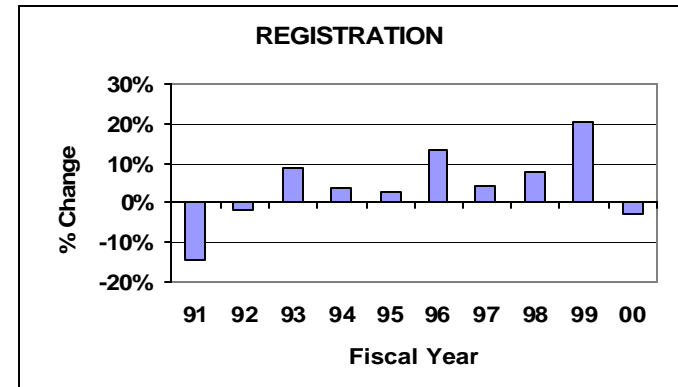

SOURCE: BLUE CHIP CONSENSUS - 6/00

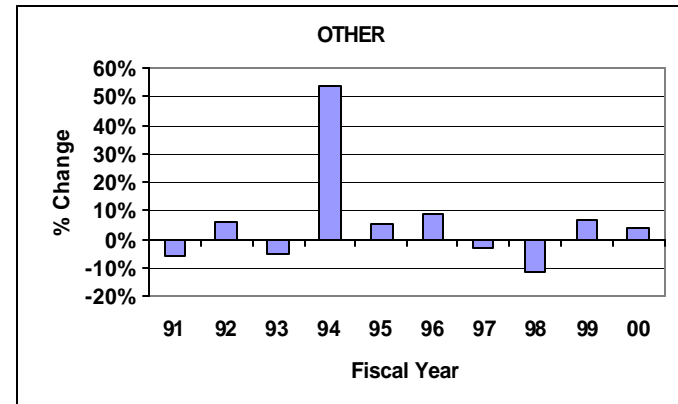

REVENUE COMPOSITION COMPARISON

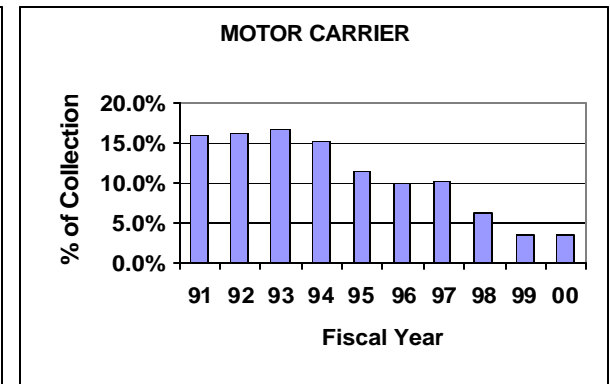
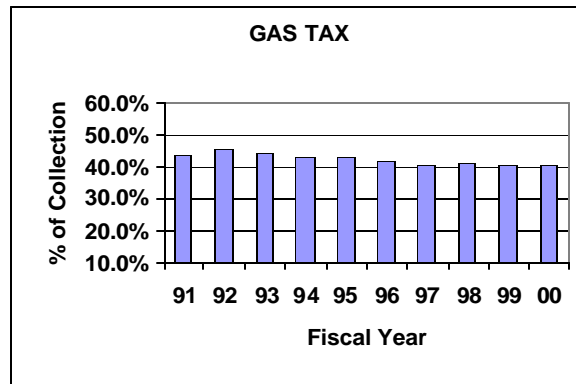
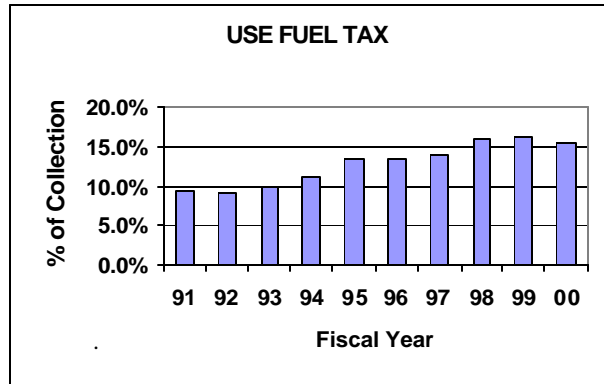

Gas Tax and Use Fuel Tax revenues were negatively impacted by larger than usual refunds for prior years and increased fuel prices in the last half of the fiscal year. The steady increase in VLT collections is a result of a healthy economy in Arizona and the high volume sales of new vehicles. The motor carrier tax continues to decrease as a percentage of total HURF collections due to legislative changes passed in 1994 and 1997.

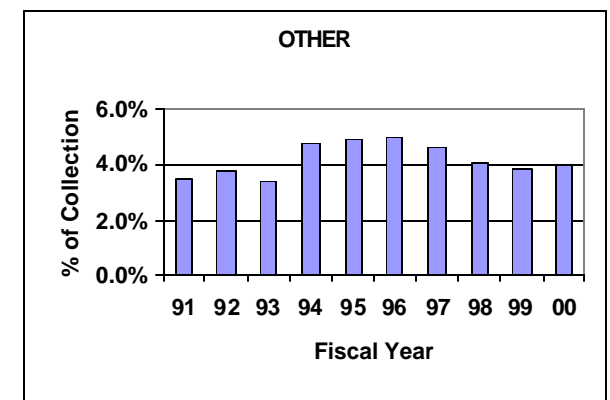
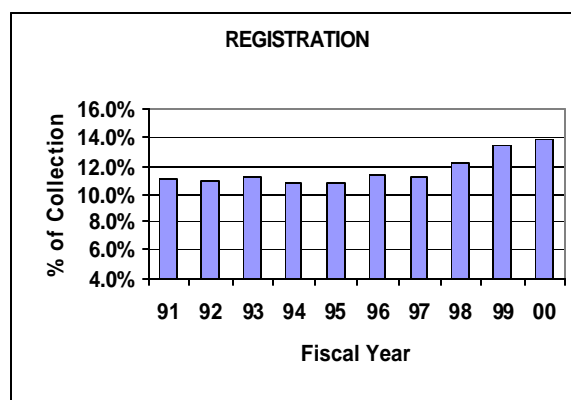
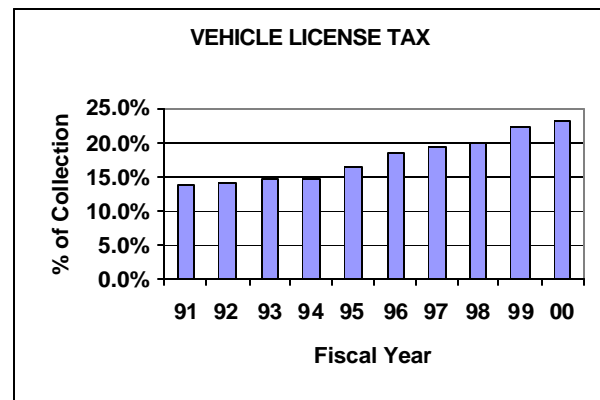

ARIZONA HIGHWAY USER REVENUE FUND SOURCES AND USES OF FUNDS

FY 2000

TOTAL: \$1,019.6 MILLION

SOURCES

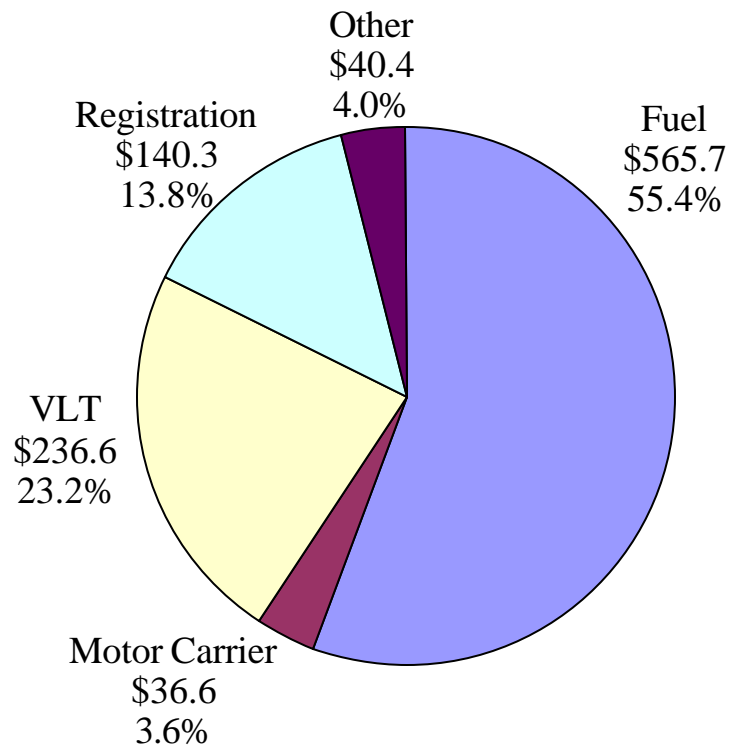

DISTRIBUTION

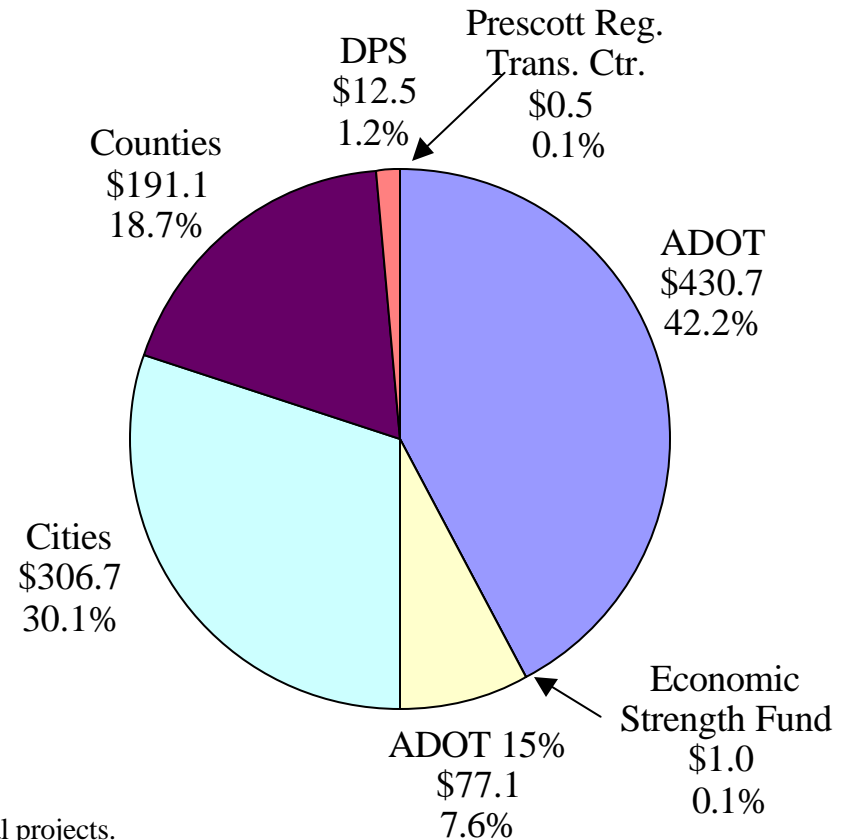

NOTE: ADOT 15% represents ADOT's allocation of HURF for MAG and PAG regional projects.

ARIZONA HIGHWAY USER REVENUE FUND

CATEGORY	FY 1999 ACTUAL	FY 2000 ACTUAL	CHANGE	FY 2000 ESTIMATE	CHANGE
GAS TAX	\$397,463,150	\$409,137,312	2.9%	\$413,400,000	-1.0%
USE FUEL TAX	160,311,949	156,598,568	-2.3%	167,500,000	-6.5%
SUBTOTAL	557,775,099	565,735,880	1.4%	580,900,000	-2.6%
MOTOR CARRIER	34,139,960	36,562,768	7.1%	34,100,000	7.2%
VEHICLE LICENSE TAX	220,126,197	236,547,180	7.5%	235,100,000	0.6%
COUNTY REGISTRATION	60,668,193	58,910,457	-2.9%	59,800,000	-1.5%
APPORTIONED	60,560,172	70,266,596	16.0%	62,100,000	13.2%
MISC. REGISTRATION	10,734,165	11,167,554	4.0%	11,100,000	0.6%
SUBTOTAL	131,962,530	140,344,607	6.4%	133,000,000	5.5%
TITLE FEES	5,903,326	6,436,271	9.0%	6,100,000	5.5%
OPERATOR LICENSES	12,954,806	14,957,509	15.5%	12,900,000	15.9%
OVERSIZE PERMITS	4,667,066	4,315,132	-7.5%	3,700,000	16.6%
INQUIRY FEES	7,688,552	8,511,457	10.7%	8,000,000	6.4%
STATION FUEL FEES	1,363,128	1,459,388	7.1%	1,200,000	21.6%
INVESTMENT INTEREST	2,148,878	2,087,976	-2.8%	2,100,000	-0.6%
MISCELLANEOUS FEES	4,049,364	2,640,901	-34.8%	5,600,000	-52.8%
SUBTOTAL	38,775,120	40,408,634	4.2%	39,600,000	2.0%
TOTAL	\$982,778,906	\$1,019,599,069	3.7%	\$1,022,700,000	-0.3%

ARIZONA HIGHWAY USER REVENUE FUND

REVENUE COLLECTIONS BY CATEGORY

(DOLLARS IN THOUSANDS)

FY 1991- 2000

Fiscal Year	Vehicle						General Fund	Total /1
	Gas Tax	Use Fuel Tax	Motor Carrier	License Tax	Registration	Other	Transfer	
1991	296,816	65,202	108,655	92,826	75,657	24,033	16,632	679,821
1992	307,879	61,910	109,573	96,146	74,180	25,507	0	675,195
1993	315,227	72,008	120,303	105,027	80,717	24,161	0	717,443
1994	334,643	87,913	118,530	113,990	83,826	37,161	0	776,063
1995	342,299	108,790	92,103	131,562	86,159	39,238	0	800,152
1996	358,961	114,780	85,433	160,145	97,601	42,654	0	859,575
1997	363,953	124,748	90,186	175,253	101,528	41,294	0	896,962
1998	366,377	142,167	63,846	176,950	101,722	36,425	0	887,487
1999	397,463	160,312	34,150	220,126	131,952	38,775	0	982,779
2000	409,137	156,599	36,563	236,547	140,345	40,409	0	1,019,599
Total	\$3,492,755	\$1,094,429	\$859,342	\$1,508,572	\$973,687	\$349,657	\$16,632	\$8,295,076

Note:

/1 Details may not add due to individual rounding.

ARIZONA HIGHWAY USER REVENUE FUND

REVENUE DISTRIBUTIONS

(DOLLARS IN THOUSANDS)

FY 1991-2000

FISCAL YEAR	ARIZONA HIGHWAY FUND	MAG CONTROLLED ACCESS	PAG CONTROLLED ACCESS	CITIES AND TOWNS	COUNTIES	ECONOMIC			TOTAL/7
						DEPT. OF PUBLIC SAFETY/1	STRENGTH PROJECT FUND/2	OTHER MISCELLANEOUS APPROPRIATIONS	
1991	294,567	39,225	13,075	208,708	123,746		500		679,821
1992	288,991	38,111	12,704	201,394	119,068	12,453	1,000	1,473 /3	675,195
1993	302,176	39,846	13,282	210,531	124,468	24,928	1,000	1,212 /3	717,443
1994	328,151	43,270	14,423	228,606	135,157	24,925	1,000	532 /3	776,063
1995	339,752	44,890	14,963	237,920	140,627	20,000	1,000	1,000 /4	800,152
1996	365,016	48,607	16,202	256,988	151,762	20,000	1,000		859,575
1997	376,193	50,573	16,858	267,931	166,908	17,500	1,000		896,962
1998	373,206	50,171	16,724	265,803	165,583	15,000	1,000		887,487
1999	413,371	55,571	18,524	294,410	183,403	12,500	1,000	4,000 /5	982,779
2000	430,668	57,896	19,299	306,729	191,077	12,500	1,000	430 /6	1,019,599
Total	\$3,512,091	\$468,160	\$156,053	\$2,479,020	\$1,501,799	\$159,806	\$9,500	\$8,647	\$8,295,076

Note:

- 1/ In certain fiscal years, the legislature has authorized the distribution of Arizona Highway User Revenue to the Arizona Department of Public Safety for highway patrol expenditures.
- 2/ The Economic Strength Project Fund was statutorily established on May 17, 1989. Money in the fund is to be used for highway projects that provide economic benefits to the State or local jurisdictions.
- 3/ Appropriation to the Motor Vehicle Division for funding of mandatory insurance enforcement administration.
- 4/ Appropriation to the Motor Vehicle Division for improvements to border area ports of entry.
- 5/ Appropriation to the Department of Commerce for Williams Gateway Authority roadway projects.
- 6/ Appropriation for the Prescott Regional Transportation Center.
- 7/ Details may not add to the total due to individual rounding.

HURF DISTRIBUTION TO ARIZONA CITIES AND COUNTIES FY 1999 -2000

COUNTY	CITY	COUNTY \$ 1\	CITY \$\$ 2\	COUNTY	CITY	COUNTY \$ 1\	CITY \$\$ 2\	COUNTY	CITY	COUNTY \$ 1\	CITY \$\$ 2\
Apache		\$6,305,936.56		La Paz		\$3,289,650.84		Pima		\$38,519,781.00	
	Eagar		\$1,070,843.22		Parker		\$1,462,159.47		Marana		\$461,530.38
	Springerville		\$463,352.07		Quartzite		\$986,854.00		Oro Valley		\$1,708,257.58
	St. Johns		\$812,086.71						South Tucson		\$486,557.20
Cochise		\$7,086,652.97		Maricopa		\$76,955,197.22		Tucson		\$46,080,665.43	
	Benson		\$390,062.11		Apache Junction		\$9,970.69		Sahuarita		\$189,962.18
	Bisbee		\$616,258.19		Avondale		\$1,630,701.80				
	Douglas		\$1,399,497.82		Buckeye		\$349,205.26		Pinal		\$9,502,626.86
	Huachuca City		\$183,806.15		Carefree		\$163,901.97		Apache Junction		\$1,847,029.65
	Sierra Vista		\$3,579,312.76		Cave Creek		\$220,623.33		Casa Grande		\$1,989,865.03
	Tombstone		\$132,671.20		Chandler		\$9,468,863.43		Coolidge		\$672,492.34
	Wilcox		\$334,865.56		El Mirage		\$412,267.25		Eloy		\$848,835.20
Coconino		\$9,225,685.08			Fountain Hills		\$1,012,184.04		Florence		\$1,081,023.13
	Flagstaff		\$7,427,210.41		Gila Bend		\$125,276.39		Keamy		\$233,886.96
	Fredonia		\$176,779.92		Gilbert		\$4,234,713.07		Mammoth		\$187,509.56
	Page		\$1,119,344.20		Glendale		\$13,088,859.32		Superior		\$331,836.17
	Williams		\$379,507.02		Goodyear		\$662,161.19				
	Sedona		\$373,887.38		Guadalupe		\$391,427.93		Santa Cruz		\$2,207,522.55
Gila		\$3,321,397.09			Litchfield Park		\$268,743.46		Nogales		\$2,129,885.29
	Globe		\$877,316.62		Mesa		\$29,515,062.78		Patagonia		\$97,815.20
	Hayden		\$113,689.95		Paradise Valley		\$893,052.11				
	Miami		\$254,128.40		Peoria		\$5,334,646.01		Yavapai		\$8,094,708.40
	Payson		\$1,366,444.94		Phoenix		\$100,347,560.99		Camp Verde		\$743,056.92
	Winkelman		\$84,375.83		Queen Creek		\$220,374.93		Chino Valley		\$624,060.66
Graham		\$1,986,684.55			Scottsdale		\$12,048,066.00		Clarkdale		\$258,374.11
	Pima		\$166,757.45		Surprise		\$767,695.07		Cottonwood		\$652,017.28
	Safford		\$792,481.26		Tempe		\$11,041,067.84		Jerome		\$46,487.03
	Thatcher		\$357,364.48		Tolleson		\$318,127.66		Prescott		\$3,048,117.11
Greenlee		\$781,523.10			Wickenburg		\$342,269.33		Prescott Valley		\$1,592,153.81
	Clifton		\$304,605.11		Youngtown		\$193,554.78		Sedona		\$621,435.73
	Duncan		\$75,049.10						Yuma		\$8,459,109.12
				Mohave		\$8,487,773.82			Somerton		\$646,707.39
					Bullhead City		\$2,923,342.48		San Luis		\$887,612.31
					Colorado City		\$346,426.70		Welton		\$125,017.04
					Kingman		\$1,818,908.03		Yuma		\$6,715,765.89
					Lake Havasu City		\$3,929,112.69				
				Navajo		\$6,852,873.93					
					Pinetop/Lakeside		\$505,302.98				
					Holbrook		\$777,411.67				
					Show Low		\$1,069,003.47				
					Snowflake		\$631,606.96				
					Taylor		\$407,047.39				
					Winslow		\$1,651,858.96				
		FISCAL YEAR 1999-2000 TOTALS:									
		CITIES: \$306,729,065.87									
		COUNTIES: \$191,077,123.09									

* Data includes FY 1997 and FY 1998 Hold Harmless adjustments for cities and towns and fuel redistribution.

HIGHWAY USER REVENUE FUND DISTRIBUTION OVERVIEW

<p><u>Revenues from:</u></p> <p>\$.18 Gas Tax \$.26 Use Fuel Tax (7/00) Vehicle Registration Motor Carrier Fee 42.75% of VLT (6/00) Other</p>	<p><u>Distribution breakdown:</u></p> <p>50.5% to State Highway Fund</p> <p>27.5% to Cities & Towns</p> <p>3% to Cities over 300,000</p> <p>19% to Counties</p>	<p><u>Distribution formulas:</u></p> <p>7.67% to Maricopa and Pima Counties for Controlled Access with a 75% and 25% split respectively. (Statutory 12.6% & Special 2.6% money) 42.83% to ADOT Discretionary.</p> <p>One half distributed on basis of incorporated population and one half on the basis of county origin of gasoline sales and city or town population within each county.</p> <p>Distributed to Phoenix, Tucson and Mesa based on population.</p> <p>Distributed based on a portion of gasoline distribution and diesel fuel consumption and on a portion of unincorporated population. The split as follows: 85/15 in FY 1997, 80/20 in FY 1998, 76/24 in FY 1999, and 72/28 in FY 2000 and thereafter)</p>
<p><u>Revenues from:</u></p> <p>State General Fund Portion of VLT (6/00)</p>	<p><u>Distribution breakdown:</u></p> <p>1.66% to LTAF II/State Hwy Fnd</p> <p>5.54% to Counties (Hwy Fund)</p>	<p><u>Distribution formulas:</u></p> <p>Counties and incorporated cities and towns based on population LTAF (until September 30, 2003 and then reverts back to State Highway Fund)</p> <p>Distributed based on unincorporated population.</p>

NOTE: 1996 Session Law includes a hold harmless clause that states if an incorporated city or town would receive less than what it received in FY 1996, the balance due the city or town shall be distributed proportionately from those cities and towns receiving more than received in FY 1996.

ARIZONA DEPARTMENT OF TRANSPORTATION FY 1999-2000 HURF ACTUAL REVENUE DISTRIBUTION FLOW (Dollars in Millions)

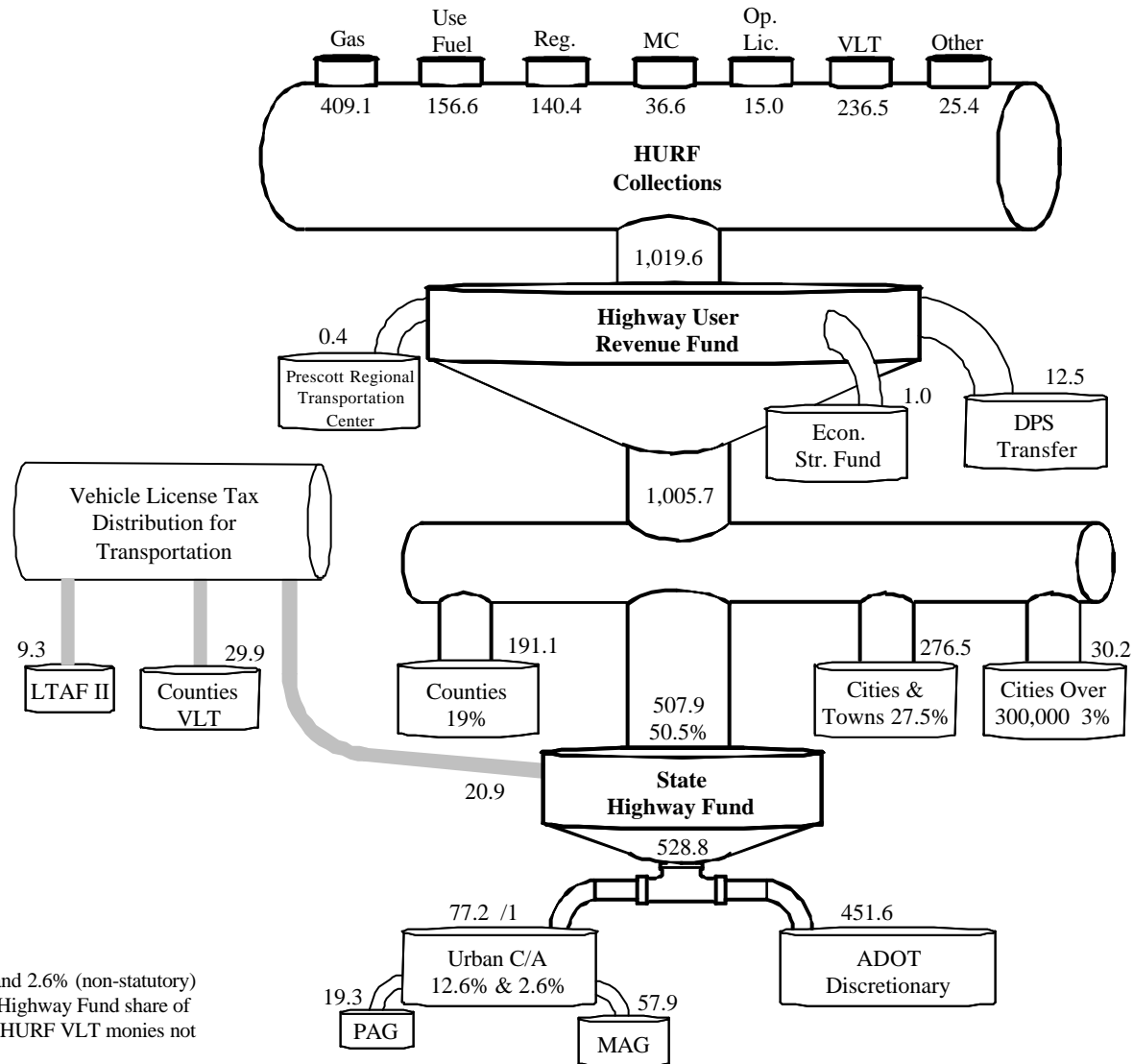

NOTE:

/1. The 12.6% (statutory) and 2.6% (non-statutory) allocations from the State Highway Fund share of HURF distributions. Non-HURF VLT monies not included.

REVENUE CATEGORY DEFINITIONS

GASOLINE TAX	A per-gallon tax imposed on gasoline used by vehicles on Arizona highways; presently this tax is \$0.18 per gallon.
USE FUEL TAX	Includes all gases and liquids used to propel motor vehicles except for motor fuel (gasoline). Use fuel consists primarily of diesel fuel. Diesel fuel tax was \$0.27 per gallon, but dropped to \$0.26 per gallon on July 1, 2000 for “use class” vehicles. “Non-use class” vehicles continue to pay \$0.18 per gallon. Jet fuel is exempt from fuel and use fuel taxes.
MOTOR CARRIER FEE	A fee imposed on certain commercial carriers based on vehicle weight. Category also includes: Motor Carrier License Tax, Motor Carrier Tax Penalties, late fees and interest, and Motor Carrier Permits Tax, and application fees.
VEHICLE LICENSE TAX	An annual license tax imposed on registered vehicles in lieu of property taxes.
REGISTRATION FEES	Is made up of three distinct components which are: County Registration - non-commercial and commercial vehicle registration, and commercial weight fees. Apportioned Registration - commercial registration fees allocated according to miles traveled in Arizona. Miscellaneous Registration - Non-resident Permits, Unassigned Registration, Prorate Stickers, and Registration Penalties.
OTHER FEES	Includes Title Fees, Operator Licenses, Oversize/Overweight Permits, Use Fuel Permits and Fuel Tax Penalties, Investment Interest, Special Plates, and other miscellaneous fees, less credit card fees.