

**ARIZONA DEPARTMENT OF TRANSPORTATION**

**ROADWAY ENGINEERING GROUP**

**ROADWAY DESIGN GUIDELINES**

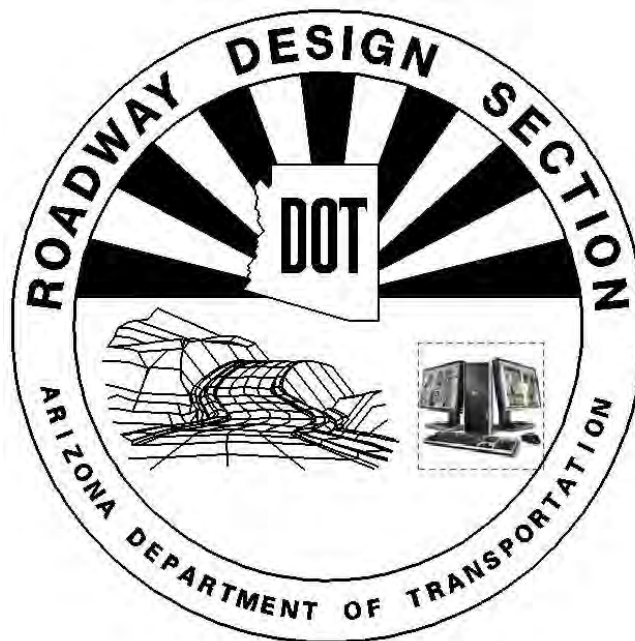

**MAY 2012**

For future updates go to:

[http://www.azdot.gov/highways/Roadway\\_Engineering/Roadway\\_Design/  
Guidelines/Manuals/PDF/RoadwayDesignGuidelines.pdf](http://www.azdot.gov/highways/Roadway_Engineering/Roadway_Design/Guidelines/Manuals/PDF/RoadwayDesignGuidelines.pdf)

DOC 31-089

**REVISIONS AND AMENDMENTS PAGE: DESIGNERS SHOULD ENSURE THEY HAVE REVIEWED THE LIST AND INCORPORATE THE REVISED PAGES.**

Text within this document that references a Section, Table or Figure normally is an active hyperlink to the specified Section, Table or Figure. Clicking on the text will take you to the destination indicated.

In addition to the above, the Table of Contents contains hyperlinks to the relevant Section, Table or Figure. Clicking on the desired line of text will take you where you want to go.

## MEMORANDUM

TO: All Users of the “Roadway Design Guidelines”

FROM: Roadway Engineering Group

DATE: April 2014

RE: Revisions to the 2012 Edition

---

Revisions affecting access control, ramp metering and earthwork cross section plotting have been made to the May 2012 Edition of the Roadway Engineering Group “Roadway Design Guidelines”. Revised pages are listed in the “Revisions and Amendments” section of the on-line manual. Revised pages within the manual are also identified with an “April 2014 Revision” header. Owners of paper copies are encouraged to print and insert the revised sheets in their manuals.

The “Roadway Design Guidelines” website address is:

<http://www.azdot.gov/docs/business/roadway-design-guidelines.pdf?sfvrsn=0>

We continue to welcome feedback from the users of this manual as it greatly contributes to the guidance provided herein.

Thank you for your attention to the April 2014 Revisions. Please distribute this memo to all design personnel, project managers, consultants and other users within your Groups and Districts.

|    |                              |                                  |
|----|------------------------------|----------------------------------|
| C: | Roadway Engineering Group    | Materials Group                  |
|    | Statewide Project Management | Right of Way Group               |
|    | Urban Project Management     | Maintenance Group                |
|    | Traffic Group                | Contracts and Specifications     |
|    | Bridge Group                 | FHWA                             |
|    | Districts (10)               | Engineering Consultants Section  |
|    | Engineering Survey Section   | Environmental Planning           |
|    | Construction Group           | Regional Traffic Engineers       |
|    | State Engineers Office       | Utility and Railroad Engineering |

## FOREWORD

Since the development of the State highway system, the Arizona Department of Transportation and its predecessor agencies have sought to establish a commonality of design philosophy among those who were designing its roadways. In the early days, the design approach was established by the chief designer who was responsible for training the design staff in the ‘Arizona approach’ and for monitoring adherence to the design philosophy. Much of this early design approach was unwritten: some procedures and criteria were formalized, but mostly, information was passed from person-to-person as “the way we do it”.

As the highway program grew, the need for standards to supplement those developed by AASHO (now AASHTO) as a national guide increased. Design charts were developed to assist the roadway designer – charts for stopping sight distance, curve superelevation and transition spirals for circular curves, among others. These were collected and became the “Roadway Standards for Field and Office” (the “D-Standards”). Other manuals followed including the “Guide for Highway Geometric Design” and the “Design Procedures Manual” for Urban Highways. The Drainage Section developed a procedures manual for the design of highway drainage systems.

With the continued growth of the Arizona State highway program, it became apparent that an expanded set of roadway design guidelines would be beneficial. It was envisioned that the guidelines would encompass all aspects of roadway design, and that it would support and coordinate with the other technical disciplines involved in the highway development process. Further, the document was to be a guide, not a “cook-book”. The roadway design process was to be based upon the engineering judgment of the designer working within accepted parameters. Accordingly, a team of engineers representing roadway design, roadway drainage, and traffic engineering was established to guide the development of such a manual. Other disciplines were brought into the process as appropriate to provide needed coordination. Concerns were raised, issues were addressed, a consensus was achieved on the ADOT approach to roadway design.

This document is the product of the many hours which the multi-discipline team devoted to developing the design consensus. It incorporates data from and replaces the “Roadway Guidelines for Use in Office and Field”, the “Guide for Highway Geometric Design”, the Urban Highway “Design Procedures Manual”, the “Drainage Manual, Volume I – Policy”, and numerous policy and design memoranda. While it was intended that the main body of the guidelines be all-inclusive, certain documents and policy statements are believed to have importance as stand-alone documents. These have been included in the appendices to the guidelines. The original 1996 guidelines were developed in metric units. In 1997, the Arizona State Legislature passed into law legislation restricting the use of metric for state highway projects. The 2007 Edition was rewritten in U.S. Customary (English) units and includes many revisions and updates based upon designer experience, plan reviews, and AASHTO updates since the original issue. Chapter 700 Earthwork, was added to this manual in May, 2002.

The 2012 Edition is the result of an evolution of design philosophy and will be updated as required to reflect current design issues and approaches.

### **Revisions and Amendments to 2012 Edition**

1. April, 2014 References – updated *ADOT Erosion and Pollution Control Manual* date and added *Ramp Metering Design Guide*.
2. April, 2014 Table of Contents, List of Figures – deleted Figure 506, added Figures 506A and 506B.
3. April, 2014 Chapter 500, pages 500-18 & 500-19, Section 504.6 – Ramp Length - revised ramp meter wording to conform with ADOT Ramp Metering Design Guide.
4. April, 2014 Chapter 500, page 500-27, Figure 504.8B – Dual Metered Ramp Geometrics at Entrance to Freeway – revised stop bar distance to conform with ADOT Ramp Metering Design Guide.
5. April, 2014 Chapter 500, page 500-28, Section 504.8 C) – One Lane Entrance with Dual Lane Ramp Metering – revised stop bar wording to conform with ADOT Ramp Metering Design Guide.
6. April, 2014 Chapter 500, page 500-41, Section 506 – Access Control – increased crossroad access control lengths at interchanges from 300 ft to 660 ft and added minimum distance to nearest signalized intersection.
7. April, 2014 Chapter 500, page 500-42, Figure 506 – Access Control at Ramp / Frontage Road with Crossroad – revised, relabeled to Figure 506B and moved to added page 500-43. Inserted Figure 506A, Access Control at Ramp / Crossroad.
8. April, 2014 Chapter 700, page 700-45, Section 709.2 A) 3) – Earthwork Documentation, Plotted Cross Sections – changed preferred cross section scale from 1" = 10' to 1" = 20'.
9. April, 2014 Appendix B, 2<sup>nd</sup> page of Index – renamed cross section examples.
10. April, 2014 Appendix B, Cross Section Examples – replaced cross section examples

---

## REFERENCES

(See Chapter 600 for Drainage Reference Materials)

1. *A Policy on Geometric Design of Highways and Streets*, AASHTO, 2011.
2. *Roadside Design Guide*, AASHTO, 2011.
3. *Highway Capacity Manual*, Transportation Research Board, 2010.
4. *Guidelines for Highways on Bureau of Land Management and U.S. Forest Service Lands*, May 2008.
5. *Manual on Uniform Traffic Control Devices*, Federal Highway Administration, Current Adopted Edition.
6. *Arizona Supplement to the MUTCD*, Current Adopted Edition.
7. *Guide for the Development of Bicycle Facilities*, AASHTO, 1999.
8. *Project Development Process Manual*, ADOT, 2008.
9. *MGT 02-1 Bicycle Policy*, ADOT, February 27, 2007.
10. *Truck Escape Ramps*, NCHRP Report 178, Synthesis of Highway Practice, May 1992.
11. *“Interim Auxiliary Lane Design Guidelines”*, Valley Transportation Group, November 1996.
12. *Guide for the Planning, Design, and Operation of Pedestrian Facilities*, AASHTO, 2004.
13. *Americans with Disabilities Act, 1991 and current updates*.
14. Roundabouts - See Section 403.2.
15. Traffic Engineering PGP 430 - *“Turn Lane Design”*
16. *Construction Standard Drawings*, Roadway Design Section, Current Edition.
17. *A Guide for Achieving Flexibility in Highway Design*, AASHTO, May 2004.
18. *Flexibility in Highway Design*, Federal Highway Administration, 1997.
19. *ADOT Erosion and Pollution Control Manual*, Current Edition.
20. *Highway Design Handbook for Older Drivers and Pedestrians*, FHWA, 2001.
21. *ADOT Freeway Management System Design Guidelines*, August 2007.
22. NCHRP Report 659 *“Guide for the Geometric Design of Driveways”*, 2010.

23. *Ramp Metering Design Guide*, ADOT, November 2013.

## TABLE OF CONTENTS

### CHAPTER 1 - INTRODUCTION

|   |     |
|---|-----|
| 1 – Highway Design Overview                               | 1-1 |
| 1.1 - Philosophy  | 1-1 |
| 1.2 – Role of Roadway Design                              | 1-2 |
| 2 – Priority Programming                                  | 1-2 |
| 2.1 – Priority Programming Group                          | 1-2 |
| 2.2 – Priority Programming Process Goals and Means        | 1-2 |
| 2.3 – Priority Programming Process                        | 1-2 |
| 2.4 – Statewide Transportation Improvement Program (STIP) | 1-3 |
| 2.5 – Design Implication                                  | 1-3 |
| 3 – Application of Guidelines                             | 1-3 |
| 3.1 – Roadway Design Guidelines                           | 1-3 |
| 3.2 – Design Exceptions/Design Variances                  | 1-4 |
| 3.3 – Other ADOT Documents                                | 1-4 |
| 3.4 – Policy on use of AASHTO Guides                      | 1-4 |

### CHAPTER 100 – DESIGN AND CRITERIA

|   |        |
|---|--------|
| 101 – Design Speed                      | 100-1  |
| 101.1 - General                         | 100-1  |
| 101.2 – Selection of Design Speed       | 100-2  |
| 101.3 – Design Speed Standards          | 100-2  |
| 102 – Design Traffic                    | 100-4  |
| 102.1 – Design Period                   | 100-4  |
| 102.2 – Traffic Design Data             | 100-4  |
| 103 – Highway Capacity                  | 100-5  |
| 103.1 – General Characteristics         | 100-5  |
| 103.2 – Levels of Service               | 100-6  |
| 103.3 – Capacity Enhancements           | 100-8  |
| 104 – Control of Access                 | 100-8  |
| 104.1 – General Policy                  | 100-8  |
| 104.2 – Direct Access                   | 100-9  |
| 104.3 – Frontage Roads                  | 100-9  |
| 105 – Roadside Installations            | 100-10 |
| 105.1 - General                         | 100-10 |
| 105.2 – Rest Stops/Roadside Parks       | 100-10 |
| 105.3 – Ports of Entry                  | 100-10 |
| 105.4 - Pullouts                        | 100-11 |
| 106 – Stage Construction                | 100-11 |
| 106.1 - General                         | 100-11 |
| 106.2 – Near Term                       | 100-12 |
| 106.3 – Interim Facilities              | 100-12 |
| 107 – Bicycle and Pedestrian Facilities | 100-13 |
| 107.1 – Bicycle Facilities              | 100-13 |
| 107.2 – Pedestrian Facilities           | 100-13 |
| 107.3 – Handicap Access                 | 100-14 |

---

|  |        |
|--|--------|
| 108 – Contractor’s Yard and Plant Site                                 | 100-15 |
| 108.1 - General  | 100-15 |
| 109 – Material and Disposal Sites                                      | 100-16 |
| 109.1 – Material Sources   | 100-16 |
| 109.2 - Material Sources in Flood Plains                               | 100-16 |
| 109.3 – Disposal Sites   | 100-17 |
| 109.4 – Salvage Material   | 100-17 |
| 110 – Scenic/Aesthetic Values  | 100-18 |
| 110.1 – Parkways/Historical and Scenic Roadways                        | 100-18 |
| 110.2 – Scenic Values  | 100-18 |
| 110.3 – Landscape and Environmental Design                             | 100-20 |
| 110.4 – Community Values / Context Sensitive Solutions                 | 100-20 |
| 111 – Coordination With Agencies                                       | 100-21 |
| 111.1 – Local Governments  | 100-21 |
| 111.2 – State Agencies   | 100-21 |
| 111.3 – Federal Highway Administration                                 | 100-22 |
| 111.4 – U.S. Forest Service (USFS) and Bureau of Land Management (BLM) | 100-22 |
| 111.5 – Other Federal Agencies   | 100-23 |
| 111.6 – Indian Tribes  | 100-23 |
| 111.7 – Private and Public Utilities                                   | 100-23 |
| 112 – Maintenance of Traffic   | 100-24 |
| 112.1 – General  | 100-24 |
| 112.2 – Traffic Control Plans  | 100-24 |
| 113 – Environmental Considerations                                     | 100-25 |
| 113.1 – Stormwater Regulations for Construction Activities             | 100-25 |
| 113.2 – Waters of the United States                                    | 100-26 |
| 113.3 – Water Quality Certification                                    | 100-26 |
| 113.4 – Contaminated Sites   | 100-26 |
| 113.5 – Wetlands   | 100-27 |
| 113.6 – Air Quality  | 100-27 |
| 113.7 – Noise Abatement  | 100-28 |
| 113.8 – Cultural Resource Preservation                                 | 100-28 |
| 113.9 – Threatened or Endangered Species                               | 100-29 |
| 113.10 – Section 4 (f)   | 100-29 |
| 113.11 – Sole Source Aquifers  | 100-29 |
| 114 – Value Analysis   | 100-30 |
| 114.1 – Policy   | 100-30 |
| 114.2 – Implementation   | 100-30 |
| 115 – Freeway Management System (FMS)                                  | 100-30 |

#### CHAPTER 200 – ELEMENTS OF DESIGN

|                                   |        |
|-----------------------------------|--------|
| 201 - Sight Distance              | 200-1  |
| 201.1 - General                   | 200-1  |
| 201.2 - Stopping Sight Distance   | 200-1  |
| 201.3 - Passing Sight Distance    | 200-2  |
| 202 - Superelevation              | 200-4  |
| 202.1 - General                   | 200-4  |
| 202.2 - Axis of Rotation          | 200-6  |
| 202.3 - Superelevation Transition | 200-9  |
| 202.4 – Superelevation Diagrams   | 200-12 |

---

|  |        |
|--|--------|
| 203 - Horizontal Alignment                               | 200-20 |
| 203.1 - General  | 200-20 |
| 203.2 - Horizontal Curvature                             | 200-20 |
| 203.3 - Spiral Transitions                               | 200-22 |
| 203.4 - Alignment Consistency                            | 200-22 |
| 203.5 - Central Angle and Curve Length                   | 200-23 |
| 203.6 - Compound Curves                                  | 200-23 |
| 203.7 - Reverse Curves                                   | 200-24 |
| 203.8 - Broken Back Curves                               | 200-24 |
| 203.9 - Alignment at Bridges                             | 200-24 |
| 204 - Vertical Alignment                                 | 200-24 |
| 204.1 - General  | 200-24 |
| 204.2 - General Guidelines                               | 200-25 |
| 204.3 - Grades   | 200-26 |
| 204.4 - Vertical Curves                                  | 200-27 |
| 204.5 - Sustained Grades                                 | 200-31 |
| 204.6 - Separate Grade Lines                             | 200-33 |
| 205 - Coordination of Vertical and Horizontal Alignments | 200-33 |
| 206 - Bridges and Grade Separation Structures            | 200-35 |
| 206.1 - General  | 200-35 |
| 206.2 - Structure Identification                         | 200-35 |
| 206.3 - Profile Gradelines at Structures                 | 200-35 |
| 206.4 - Vertical Clearance to Structures                 | 200-36 |
| 206.5 - Falsework  | 200-37 |
| 207 - Pavement and Lane Transitions                      | 200-38 |
| 208 - Airports and Airways – Highway Clearances          | 200-39 |
| 208.1 - General  | 200-39 |
| 209 - Auxiliary Lanes                                    | 200-40 |
| 209.1 - Climbing Lanes                                   | 200-40 |
| 209.2 - Passing Lanes                                    | 200-41 |
| 209.3 - Weaving Lanes                                    | 200-42 |
| 209.4 - Truck Escape Ramps                               | 200-42 |

#### CHAPTER 300 - CROSS SECTION ELEMENTS

|   |        |
|---|--------|
| 301 - Pavement                                | 300-1  |
| 301.1 - Pavement Type                         | 300-1  |
| 301.2 - Cross Slope                           | 300-1  |
| 301.3 - Lane Width and Pavement Width         | 300-2  |
| 301.4 - Pavement Details                      | 300-2  |
| 302 - Shoulders                               | 300-2  |
| 302.1 - Shoulder Structural Section           | 300-2  |
| 302.2 - Shoulder Curbs (Standard C-05.10)     | 300-4  |
| 302.3 - Continuous Longitudinal Rumble Strips | 300-10 |
| 302.4 - Shoulder Width                        | 300-11 |
| 302.5 - Shoulder Width Tapers                 | 300-12 |
| 302.6 - Shoulder Slopes                       | 300-12 |

---

|   |        |
|---|--------|
| 303 - Side Slopes                                 | 300-12 |
| 303.1 - General                                   | 300-12 |
| 303.2 - Roadside Recovery Area                    | 300-14 |
| 303.3 - Side Slopes                               | 300-19 |
| 303.4 - Topsoil Plating                           | 300-20 |
| 303.5 - Cross-Facility Embankment Slopes          | 300-20 |
| 303.6 - Clearance from Slope to Right-of-Way Line | 300-20 |
| 303.7 - Slope Benches and Cut Widening            | 300-20 |
| 303.8 - False Cuts                                | 300-21 |
| 303.9 - Special Slope Treatments                  | 300-22 |
| 304 - Medians                                     | 300-22 |
| 304.1 - General                                   | 300-22 |
| 304.2 - Widening for Bridge Piers                 | 300-23 |
| 304.3 - Median Cross Slopes                       | 300-24 |
| 304.4 - Median Barriers                           | 300-28 |
| 304.5 - Median Curbs                              | 300-28 |
| 304.6 - Paved Medians                             | 300-28 |
| 305 - Barriers                                    | 300-29 |
| 305.1 - General                                   | 300-29 |
| 305.2 - Barrier Types                             | 300-29 |
| 305.3 - Guardrail                                 | 300-29 |
| 305.4 - Safety-Shape Barriers                     | 300-30 |
| 305.5 - Cable Barriers                            | 300-31 |
| 305.6 - Crash Cushions                            | 300-31 |
| 305.7 - Guardrail and Embankment Curbs            | 300-32 |
| 305.8 - Barrier Length                            | 300-33 |
| 305.9 - Barrier Transitions                       | 300-35 |
| 305.10 - End Treatment                            | 300-37 |
| 305.11 - Barriers at Bridge Ends                  | 300-37 |
| 306 - Typical Cross Sections                      | 300-37 |
| 306.1 - General                                   | 300-37 |
| 306.2 - Rural Cross Sections                      | 300-38 |
| 306.3 - Fringe-Urban Cross Sections               | 300-42 |
| 306.4 - Urban Cross Sections                      | 300-46 |
| 306.5 - State Funding Exclusions                  | 300-51 |
| 306.6 - Cross Sections for Other Agencies         | 300-51 |
| 307 - Right-of-Way                                | 300-51 |
| 308 - Horizontal/Lateral Clearances               | 300-52 |
| 309 - Frontage Roads                              | 300-52 |
| 310 - Sidewalks and Sidewalk Ramps                | 300-55 |
| 311 - Earth Retaining Structures                  | 300-55 |
| 311.1 - General                                   | 300-55 |
| 312 - Noise Barriers                              | 300-57 |
| 313 - Right-of-Way Fence                          | 300-57 |
| 314 - Miscellaneous                               | 300-58 |
| 314.1 - Cattle Guards                             | 300-58 |
| 314.2 - Right-of-Way Markers                      | 300-58 |
| 314.3 - Survey Monuments                          | 300-58 |

---

|                              |        |
|------------------------------|--------|
| 315 - Temporary Connections  | 300-58 |
| 316 - Detours                | 300-59 |
| 316.1 - General              | 300-59 |
| 316.2 - Traffic Lanes        | 300-59 |
| 316.3 - Design Speed         | 300-60 |
| 316.4 - Horizontal Alignment | 300-61 |
| 316.5 - Superelevation       | 300-64 |
| 316.6 - Vertical Alignment   | 300-64 |
| 316.7 - Drainage             | 300-64 |
| 316.8 - Other Features       | 300-65 |

#### CHAPTER 400 – AT-GRADE INTERSECTIONS

|  |        |
|--|--------|
| 401 - Introduction                         | 400-1  |
| 402 - Design Considerations                | 400-1  |
| 402.1 - General                            | 400-1  |
| 402.2 - Design Elements                    | 400-2  |
| 403 - Intersection Types                   | 400-3  |
| 403.1 - Basic Types of Intersections       | 400-3  |
| 403.2 - Modern Roundabouts                 | 400-6  |
| 403.3 - Channelized Intersections          | 400-10 |
| 403.4 - Skewed Intersections               | 400-11 |
| 404 - Driveway and Turnout Access          | 400-11 |
| 404.1 - General                            | 400-11 |
| 404.2 - Driveway and Turnout Types         | 400-12 |
| 404.3 - Driveway and Turnout Grades        | 400-12 |
| 404.4 - Driveway and Turnout Paving        | 400-13 |
| 405 - Road Access Openings and Connections | 400-13 |
| 405.1 - Access Openings on Freeways        | 400-13 |
| 405.2 - Access Openings on Other Highways  | 400-14 |
| 406 - Channelization of Intersections      | 400-14 |
| 406.1 - General                            | 400-14 |
| 406.2 - Preference to Major Movements      | 400-14 |
| 406.3 - Areas and Points of Conflict       | 400-15 |
| 406.4 - Refuge and Storage Areas           | 400-15 |
| 406.5 - Traffic Control Devices            | 400-15 |
| 407 - Design Vehicles                      | 400-15 |
| 407.1 - General                            | 400-15 |
| 407.2 - Design Vehicle Selection           | 400-16 |
| 407.3 - Design Vehicle Templates           | 400-17 |
| 408 - Intersection Design                  | 400-17 |
| 408.1 - General                            | 400-17 |
| 408.2 - Application of Sight Distance      | 400-17 |
| 408.3 - Stopping Sight Distance            | 400-18 |
| 408.4 - Intersection Sight Distance        | 400-19 |
| 408.5 - Intersection Control               | 400-21 |
| 408.6 - Decision Sight Distance            | 400-26 |
| 408.7 - Effect of Skew                     | 400-26 |
| 408.8 - Intersection Vertical Profile      | 400-27 |
| 408.9 - Effect of Horizontal Alignment     | 400-27 |

---

|  |        |
|--|--------|
| 408.10 - Left-Turn Channelization                    | 400-28 |
| 408.11 - Right-Turn Channelization                   | 400-29 |
| 408.12 - Acceleration Lanes                          | 400-31 |
| 408.13 - Traffic Islands                             | 400-35 |
| 408.14 - Turning Roadways and Intersection Curvature | 400-36 |

### CHAPTER 500 - TRAFFIC INTERCHANGES

|  |        |
|--|--------|
| 501 - Introduction   | 500-1  |
| 501.1 - General  | 500-1  |
| 501.2 - Spacing  | 500-1  |
| 502 - Interchange Types                                    | 500-1  |
| 502.1 - General  | 500-1  |
| 502.2 - Diamond Interchanges                               | 500-4  |
| 502.3 - Loop Interchanges                                  | 500-5  |
| 502.4 - Directional Interchanges                           | 500-6  |
| 503 - Interchange Selection and Design                     | 500-7  |
| 503.1 - General Considerations                             | 500-7  |
| 503.2 - General Design Guidelines                          | 500-9  |
| 503.3 - Design Speed                                       | 500-9  |
| 503.4 - Sight Distance                                     | 500-10 |
| 503.5 - Interchange Alignment                              | 500-10 |
| 504 - Ramp Design  | 500-11 |
| 504.1 - Ramp Vertical Alignment                            | 500-11 |
| 504.2 - Ramp Horizontal Alignment                          | 500-11 |
| 504.3 - Ramp Superelevation                                | 500-12 |
| 504.4 - Side Slopes  | 500-13 |
| 504.5 - Ramp Width   | 500-16 |
| 504.6 - Ramp Length  | 500-18 |
| 504.7 - Ramp Geometrics at Exit from Mainline              | 500-18 |
| 504.8 - Ramp Geometrics at Entrance to Mainline            | 500-23 |
| 504.9 - Mainline Auxiliary Lanes                           | 500-28 |
| 505 - Ramp / Crossroad Design                              | 500-29 |
| 505.1 - Diamond Ramp Geometrics at Crossroad Intersections | 500-29 |
| 505.2 - Single Point Urban Interchange (SPUI)              | 500-37 |
| 505.3 - Crossroad Transitions                              | 500-39 |
| 506 - Access Control                                       | 500-41 |

### CHAPTER 600 – HIGHWAY DRAINAGE DESIGN

|  |       |
|--|-------|
| 601 – General  | 600-1 |
| 601.1 – Design Philosophy                                  | 600-1 |
| 601.2 – Design Guidelines                                  | 600-1 |
| 602 – Legal and Statutory Requirements                     | 600-2 |
| 602.1 – General  | 600-2 |
| 602.2 – Corps of Engineers –“404” Permits                  | 600-2 |
| 602.3 – Stormwater Regulations for Construction Activities | 600-3 |
| 602.4 – Federal Highway Administration                     | 600-3 |
| 602.5 – Local Flood Control Agencies                       | 600-3 |

---

|  |        |
|--|--------|
| 603 – Storm Frequency and Design Discharge               | 600-4  |
| 603.1 – General  | 600-4  |
| 603.2 – Design Storm Frequency                           | 600-4  |
| 604 – Hydrology  | 600-9  |
| 604.1 – General  | 600-9  |
| 604.2 – Hydrologic Methods                               | 600-9  |
| 605 – Documentation                                      | 600-10 |
| 605.1 – Reports  | 600-10 |
| 605.2 – Field Investigations                             | 600-10 |
| 605.3 – Drainage Easements                               | 600-10 |
| 606 – Roadway Drainage                                   | 600-11 |
| 606.1 – Design Methodology                               | 600-11 |
| 606.2 – Inlets   | 600-11 |
| 606.3 – Median Drainage                                  | 600-12 |
| 606.4 – Bridge Decks                                     | 600-15 |
| 607 – Storm Drains                                       | 600-15 |
| 607.1 – Design Considerations                            | 600-15 |
| 607.2 – Manholes (Construction Standard Drawing C-18.10) | 600-15 |
| 607.3 – Lateral Connections                              | 600-16 |
| 607.4 – Pipe Roughness                                   | 600-16 |
| 607.5 – Guidelines for use of Pipe Materials             | 600-16 |
| 608 – Channels and Ditches                               | 600-17 |
| 608.1 – Channels   | 600-17 |
| 608.2 – Hydraulic Design of Open Channels                | 600-17 |
| 608.3 – Channel Transitions                              | 600-18 |
| 608.4 – Freeboard  | 600-20 |
| 608.5 – Superelevation                                   | 600-20 |
| 608.6 – Channel Lining                                   | 600-21 |
| 608.7 – Cutoff Walls                                     | 600-21 |
| 608.8 – Drainage Outlets into Major Watercourses         | 600-21 |
| 608.9 – Channel Inflows                                  | 600-21 |
| 608.10 – Energy Dissipators                              | 600-22 |
| 608.11 – Maintenance                                     | 600-22 |
| 608.12 – Ditches   | 600-22 |
| 609 – Detention Basins                                   | 600-22 |
| 609.1 – General  | 600-22 |
| 609.2 – Layout   | 600-23 |
| 609.3 – Detention Basin Routing                          | 600-23 |
| 609.4 – Emergency Spillways                              | 600-23 |
| 610 – Bridges  | 600-24 |
| 610.1 – Hydraulic Design                                 | 600-24 |
| 610.2 – Structure Considerations                         | 600-24 |
| 611 – Culverts   | 600-26 |
| 611.1 – General  | 600-26 |
| 611.2 – Material   | 600-26 |
| 611.3 – Design Considerations                            | 600-26 |
| 612 - Erosion and Sediment                               | 600-29 |
| 612.1 – Erosion and Sediment Control Measures            | 600-29 |
| 612.2 – Erosion Control                                  | 600-29 |

|                                   |        |
|-----------------------------------|--------|
| 613 – Bank Protection             | 600-30 |
| 613.1 – General                   | 600-30 |
| 613.2 – Design Considerations     | 600-30 |
| 614 – Pump Stations               | 600-31 |
| 614.1 – General                   | 600-31 |
| 614.2 – Storage Reservoirs        | 600-31 |
| 614.3 – Storage Reservoir Routing | 600-31 |
| 614.4 – Pump Capacity             | 600-32 |
| 614.5 – Layout of Pump Stations   | 600-32 |
| Drainage Reference List           | 600-33 |
| Drainage Glossary                 | 600-34 |

## CHAPTER 700 EARTHWORK DESIGN

|                                     |       |
|-------------------------------------|-------|
| 701 – Introduction                  | 700-1 |
| 701.1 - Purpose                     | 700-1 |
| 701.1.1 - Earthwork Design Approach | 700-1 |
| 701.2 - Requirements                | 700-2 |
| 701.3 - Process Description         | 700-3 |
| Roadway Template                    | 700-3 |
| Determining Quantities              | 700-3 |
| 701.4 - Definitions/Concepts        | 700-7 |

### Types of Excavation

|                              |        |
|------------------------------|--------|
| Roadway Excavation           | 700-7  |
| Drainage Excavation          | 700-7  |
| Channel Excavation           | 700-7  |
| Structural Excavation        | 700-7  |
| Pipe Excavation              | 700-7  |
| Topsoil Excavation           | 700-7  |
| Topsoil                      | 700-7  |
| Landscape Excavation         | 700-8  |
| MSE Wall Excavation          | 700-8  |
| Overexcavation               | 700-8  |
| Collapsible Soils            | 700-8  |
| Benching (Fill Slopes)       | 700-8  |
| Benching (Cut Slopes)        | 700-8  |
| Mini-benching (Cut Slopes)   | 700-8  |
| Borrow                       | 700-9  |
| Waste                        | 700-9  |
| Grading Roadway for Pavement | 700-9  |
| Haul Out                     | 700-9  |
| Haul In                      | 700-10 |

### Types of Embankment

|                    |        |
|--------------------|--------|
| Roadway Embankment | 700-10 |
| Ground Compaction  | 700-10 |
| Dikes and Berms    | 700-10 |
| Plating            | 700-10 |

---

| Other Items |  |        |
|-------------|--|--------|
|             | Shoulder Build-up  | 700-14 |
|             | Guardrail Related Earthwork                                  | 700-14 |
|             | Pipe Backfill and Trench Backfill                            | 700-14 |
|             | Bedding  | 700-15 |
|             | Structure Backfill   | 700-15 |
|             | MSE Wall Backfill  | 700-15 |
|             | Culvert Quantity Adjustments (Pipe Culvert and Box Culverts) | 700-15 |
|             | Existing Roadway Pavement Structure                          | 700-16 |
|             | Slope Rounding   | 700-16 |
|             | Balanced Earthwork Project                                   | 700-16 |
|             | Balanced Earthwork Quantities                                | 700-17 |
| 702 –       | Existing Ground Data   | 700-17 |
|             | 702.1 - Cross Sections                                       | 700-17 |
|             | 702.2 - Field Surveyed Cross Sections                        | 700-17 |
|             | 702.3 - Digital Terrain Modeling                             | 700-19 |
|             | 702.4 - Photogrammetry                                       | 700-19 |
|             | 702.5 - Phased Construction Groundline                       | 700-20 |
| 703 –       | Templates  | 700-22 |
|             | 703.1 - General  | 700-22 |
|             | 703.2 - Urban Highways                                       | 700-22 |
|             | 703.3 - Rural Highways                                       | 700-22 |
|             | 703.4 - Special Conditions                                   | 700-22 |
|             | 703.5 - Plating  | 700-22 |
|             | 703.6 - Topsoil Excavation                                   | 700-22 |
| 704 –       | Slopes   | 700-29 |
|             | 704.1 - General  | 700-29 |
|             | 704.2 - Materials Design Report                              | 700-29 |
|             | 704.3 - Cut Slopes   | 700-29 |
|             | 704.4 - Fill Slopes  | 700-29 |
|             | 704.5 - Contour Grading                                      | 700-32 |
| 705 –       | Drainage Related Earthwork                                   | 700-32 |
|             | 705.1 - General  | 700-32 |
|             | 705.2 - Channels and Dikes                                   | 700-32 |
|             | 705.3 - Pipe Backfill, Trench Backfill And Bedding           | 700-32 |
|             | 705.4 - Structural Backfill                                  | 700-32 |
|             | 705.5 - Pipe Excavation and Structure Excavation             | 700-32 |
| 706 –       | Material Factors   | 700-37 |
|             | 706.1 - Shrinkage and Swell                                  | 700-37 |
|             | 706.2 - Ground Compaction                                    | 700-37 |
| 707 –       | Miscellaneous Earthwork                                      | 700-38 |
|             | 707.1 - Unsuitable Materials                                 | 700-38 |
|             | 707.2 - Turnouts   | 700-38 |
|             | 707.3 - Cross Roads  | 700-38 |
|             | 707.4 - Rest Areas   | 700-38 |
|             | 707.5 - Interchanges   | 700-38 |
|             | 707.6 - Bridges  | 700-38 |
|             | 707.7 - Detours  | 700-39 |
|             | 707.8 - Roadway Connections                                  | 700-39 |
|             | 707.9 - Mechanically Stabilized Earth (MSE) Retaining Walls  | 700-39 |

|   |        |
|---|--------|
| 708 – Mass Diagram  | 700-40 |
| 709 – Documentation Requirements                          | 700-43 |
| 709.1 - Earthwork to be shown on the Plans                | 700-43 |
| Final Earthwork Summary                                   | 700-43 |
| Top Soil Excavation Limits                                | 700-43 |
| 709.2 - Earthwork Documentation                           | 700-45 |
| A) Documentation of Quantities (Provided in a booklet)    | 700-45 |
| 1) Station to Station Listing of Quantities               | 700-45 |
| 2) Other Earthwork Supporting Quantities and Calculations | 700-45 |
| 3) Plotted Cross Sections                                 | 700-45 |
| 710 – Quality Procedures                                  | 700-46 |
| 711 – Software  | 700-46 |
| 712 – Other Considerations                                | 700-46 |
| Constructability Issues                                   | 700-46 |

## APPENDICES

|            |  |
|------------|--|
| APPENDIX A | ROADWAY DESIGN POLICIES AND PROCEDURES                         |
| APPENDIX B | EARTHWORK EXAMPLES   |
| APPENDIX C | OPERATIONAL DRAINAGE FREQUENCY CLASS MAP for<br>STATE HIGHWAYS |

## LIST OF TABLES

|              |   |        |
|--------------|---|--------|
| Table 101.3  | Relation of Highway Type to Design Speed                              | 100-3  |
| Table 103.2A | Relation of Highway Type to Design Levels of Service                  | 100-7  |
| Table 201.3  | Minimum Passing Sight Distance for Given Design Speed                 | 200-4  |
| Table 202.1A | Relation of Highway Types to Maximum Superelevation                   | 200-5  |
| Table 202.1B | Relation of Design Speed to Maximum Side Friction, $f$                | 200-5  |
| Table 202.3A | Superelevation Rates and Transition Lengths for $e_{max}=0.040$ ft/ft | 200-16 |
| Table 202.3B | Superelevation Rates and Transition Lengths for $e_{max}=0.060$ ft/ft | 200-17 |
| Table 202.3C | Superelevation Rates and Transition Lengths for $e_{max}=0.080$ ft/ft | 200-18 |
| Table 202.3D | Superelevation Rates and Transition Lengths for $e_{max}=0.100$ ft/ft | 200-19 |
| Table 204.3  | Relation of Highway Types to Maximum Grades                           | 200-26 |
| Table 204.4  | Relation of Highway Types to Vertical Curve Minimum Lengths           | 200-27 |
| Table 209.4  | Values of Rolling Resistance "R" for Different Materials              | 200-46 |
| Table 302.4  | Paved Shoulder Width  | 300-11 |
| Table 303.2A | Recovery Area Width Criteria  | 300-14 |
| Table 303.2B | Curvature Modification Factors for Recovery Area Widths               | 300-15 |
| Table 305.8  | Roadside Barrier Runout Length  | 300-33 |
| Table 407.2  | Intersection Design Vehicles  | 400-16 |
| Table 408.2  | Application of Sight Distance Requirements                            | 400-18 |
| Table 408.14 | Minimum Radii and Superelevation for Low Speed Turning Roadways       | 400-37 |
| Table 603.2A | Minimum Design Storm Frequency for Bridges and Culverts               | 600-6  |
| Table 603.2B | Design Storm Frequency for Pavement Drainage Systems                  | 600-7  |
| Table 603.2C | Allowable Spread 10-year Storm Event                                  | 600-7  |
| Table 606.2  | Inlet Capture Ratios  | 600-12 |
| Table 607.2  | Maximum Manhole Spacing   | 600-16 |
| Table 607.4  | Manning's "n"   | 600-16 |
| Table 608.3  | Channel Expansion and Contraction Transition Rates                    | 600-18 |

## LIST OF FIGURES

|                |   |        |
|----------------|---|--------|
| Figure 201.2   | Relation Of Stopping Sight Distance To Design Speed<br>And Effective Grade        | 200-3  |
| Figure 202.2   | Location of Superelevation Axis of Rotation                                       | 200-8  |
| Figure 202.3A  | Superelevation Transition Distribution  | 200-13 |
| Figure 202.3B  | Superelevation Transition Distribution  | 200-14 |
| Figure 202.3C  | Superelevation Transition Distribution  | 200-15 |
| Figure 203.2   | Stopping Sight Distance Horizontal Curves   | 200-21 |
| Figure 204.4A  | Relation of Minimum Length of Crest Vertical Curves<br>to Stopping Sight Distance | 200-28 |
| Figure 204.4B  | Relation of Minimum Length of Crest Vertical Curves<br>to Passing Sight Distance  | 200-29 |
| Figure 204.4C  | Relation of Minimum Length of Sag Vertical Curves<br>to Stopping Sight Distance   | 200-30 |
| Figure 204.5   | Relation of Reduction of Truck Operating Speed to<br>Length of Upgrade            | 200-32 |
| Figure 209.4A  | Consideration of Truck Ramps Versus Length & Percent<br>Of Downgrade              | 200-45 |
| Figure 209.4B  | Typical Layout Truck Escape Ramp  | 200-47 |
| Figure 302.1   | Urban Highways Typical Shoulder Treatments  | 300-3  |
| Figure 302.2A  | Urban Freeway Curb & Gutter Guidelines  | 300-6  |
| Figure 302.2B  | Urban Freeway Curb & Gutter Guidelines  | 300-7  |
| Figure 302.2C  | Urban Freeway Curb & Gutter Guidelines  | 300-8  |
| Figure 302.2D  | Urban Freeway Curb & Gutter Guidelines  | 300-9  |
| Figure 303.1   | Side Slope Nomenclature   | 300-13 |
| Figure 303.2   | Barrier Warrants for Embankment Sections  | 300-18 |
| Figure 304.3A  | Rural & Fringe-Urban Divided Highways, 46' Median<br>Configurations               | 300-25 |
| Figure 304.3B  | Rural 84' Median Configurations   | 300-26 |
| Figure 304.3C  | Urban Controlled Access, 46' Median Configurations                                | 300-27 |
| Figure 305.8   | Approach Barrier For One & Two-Way Traffic  | 300-34 |
| Figure 305.9   | Median Barrier Transition At Piers, Sign Base and Light Pole                      | 300-36 |
| Figure 306.2   | Rural Highway Typical Sections  | 300-41 |
| Figure 306.3   | Fringe-Urban Highway Typical Sections   | 300-45 |
| Figure 306.4A  | Urban Highway Typical Sections  | 300-48 |
| Figure 306.4B  | Controlled Access Urban Highway Typical Sections                                  | 300-49 |
| Figure 306.4C  | Urban Highway Sidewalk Locations  | 300-50 |
| Figure 309A    | One-Way Frontage Road Typical Sections And<br>Slope Treatments                    | 300-53 |
| Figure 309B    | Two-Way Frontage Road Typical Sections And<br>Slope Treatments                    | 300-54 |
| Figure 316.4   | Detour Clearances at Bridges  | 300-63 |
| Figure 403.1   | Basic Types of At-Grade Intersections   | 400-4  |
| Figure 403.2   | Modern Roundabout   | 400-5  |
| Figure 408.4A  | Approach Sight Triangles  | 400-20 |
| Figure 404.4B  | Departure Sight Triangles   | 400-20 |
| Figure 408.11A | Bicycle Buffer – Wide Curb Lane   | 400-32 |
| Figure 408.11B | Bicycle Buffer – Non-Curb & Gutter  | 400-33 |
| Figure 408.12A | Acceleration Lane Configuration   | 400-34 |

|                |  |        |
|----------------|--|--------|
| Figure 408.12B | Minimum Acceleration Lane Configuration                  | 400-34 |
| Figure 502.1   | Interchange Types, Sheet 1 of 2                          | 500-2  |
| Figure 502.1   | Interchange Types, Sheet 2 of 2                          | 500-3  |
| Figure 504.4A  | Preferred Ramp Side Slopes, Urban Area                   | 500-14 |
| Figure 504.4B  | Preferred Ramp Side Slopes, Rural Area                   | 500-15 |
| Figure 504.5   | Ramp Widths And Pavement Tapers                          | 500-17 |
| Figure 504.7   | Ramp Geometrics At Exit From Freeway, Sheet 1 of 3       | 500-20 |
| Figure 504.7   | Ramp Geometrics At Exit From Freeway, Sheet 2 of 3       | 500-21 |
| Figure 504.7   | Ramp Geometrics At Exit From Freeway, Sheet 3 of 3       | 500-22 |
| Figure 504.8A  | Ramp Geometrics At Entrance To Freeway, Sheet 1 of 2     | 500-25 |
| Figure 504.8A  | Ramp Geometrics At Entrance To Freeway, Sheet 2 of 2     | 500-26 |
| Figure 504.8B  | Dual-Metered Ramp Geometrics At Entrance To Freeway      | 500-27 |
| Figure 505.1A  | Typical Ramp / Frontage Road With Crossroad Intersection | 500-32 |
| Figure 505.1B  | 4 - Lane Crossroad / Ramp Intersection, Sheet 1 of 2     | 500-33 |
| Figure 505.1B  | 4 - Lane Crossroad / Ramp Intersection, Sheet 2 of 2     | 500-34 |
| Figure 505.1C  | Entrance Ramp Terminus Layout, Sheet 1 of 2              | 500-35 |
| Figure 505.1C  | Exit Ramp Terminus Layout, Sheet 2 of 2                  | 500-36 |
| Figure 505.2   | Single Point Urban Interchange                           | 500-38 |
| Figure 505.3   | Typical Crossroad Transition At Ramp Intersection        | 500-39 |
| Figure 506A    | Access Control At Ramp / Crossroad                       | 500-42 |
| Figure 506B    | Access Control At Ramp / Frontage Road with Crossroad    | 500-43 |
| Figure 603.2A  | Allowable Spread At Ramp Gores                           | 600-8  |
| Figure 606.2A  | Bicycle Safe Grates At Ramps / Crossroads                | 600-13 |
| Figure 606.2B  | Bicycle Safe Grates At Ramps / Frontage Roads            | 600-14 |
| Figure 608.3   | Open Channel Vertical Wall Transition                    | 600-19 |
| Figure 701.3A  | Roadway Template   | 700-5  |
| Figure 701.3B  | Cut and Fill Cross Sections                              | 700-6  |
| Figure 701.4A  | Typical Benching (Fill Slopes)                           | 700-11 |
| Figure 701.4B  | Typical Benching (Cut Slope)                             | 700-12 |
| Figure 701.4C  | Ground Compaction Applications                           | 700-13 |
| Figure 702.1   | Additional Cross Section Locations                       | 700-18 |
| Figure 702.5   | Phased Construction Ground Lines                         | 700-21 |
| Figure 703.1   | Template Widths Through Super Elevated Sections          | 700-23 |
| Figure 703.2   | Urban Template   | 700-24 |
| Figure 703.3   | Rural Template   | 700-24 |
| Figure 703.4A  | Tangent Roadway and Superelevated Roadway Templates      | 700-25 |
| Figure 703.4B  | Ramp Templates   | 700-26 |
| Figure 703.4C  | Rounding   | 700-27 |
| Figure 703.5   | Plating and Topsoil Excavation (Urban Freeways)          | 700-28 |
| Figure 704.3A  | Fill-to-Cut Shoulder Transitions                         | 700-30 |
| Figure 704.3B  | Sliver Cut and Fills                                     | 700-31 |
| Figure 704.5   | Contour Grading  | 700-33 |
| Figure 705.3   | Storm Drains and Pipeline Excavation                     | 700-34 |
| Figure 705.4   | Structure Backfill Payment Limits                        | 700-35 |
| Figure 705.5   | Structural Excavation Payment Limits                     | 700-36 |
| Figure 708.1   | Relationship Between Profile and Mass Diagram            | 700-41 |
| Figure 709.1   | Earthwork Summary Table Quantity Check                   | 700-44 |

## CHAPTER 1

### INTRODUCTION

The Roadway Engineering Group is dedicated to providing efficient delivery of high quality design and preconstruction documents resulting in the highest quality State highway system considering safety, service, environment and cost-effectiveness.

#### **1 – Highway Design Overview**

##### **1.1 – Philosophy**

The ADOT highway design process requires the judicious application of engineering principles to meet each project's objectives in the best overall public interest. Application of these principles may require the consideration and balancing of a number of social, economic and environmental issues including:

- a) Need for safe and efficient transportation.
- b) Planning based on realistic financial estimates.
- c) Cost of mitigating adverse effects on natural resources, environmental values, public services, aesthetic values, and community goals and objectives.
- d) The cost, ease and safety of maintaining the constructed project.

To properly consider these items, the project team must view the highway from the perspective of the user, the community and the public at large. To the user, the safe and efficient movement from one point to another is of paramount concern. The community is often most interested in aesthetic, social, and other impacts of the facility. The people of the State at large are generally concerned about the effective and fair utilization and distribution of available funds. Therefore, ADOT's development of highway projects reflects both the overall system benefits and community goals, plans, and values.

## **1.2 – Role of Roadway Design**

Within the highway design philosophy and the ADOT project team approach to project development, the roadway designer has the responsibility to contribute the most desirable design parameters consistent with safety, service, environment and cost effectiveness and to apply these parameters with sound engineering judgment. This Manual will guide the roadway designer in determining the appropriate design parameters.

## **2 – Priority Programming**

### **2.1 – Priority Programming Group**

The Priority Programming Group in the ADOT Multimodal Planning Division is responsible for developing the Five-Year Transportation Facilities Construction Program for highways and airports under the Priority Programming Law. The law sets guidelines that are followed in prioritizing projects for the program.

### **2.2 – Priority Programming Process Goals and Means**

The primary goal of ADOT is to provide a transportation system together with the means of revenue collection, licensing and safety that meets the needs of the citizens of Arizona. The Priority Programming Law is designed to establish a program that is responsive to citizen needs while remaining secure from special interest pressure. Specific criteria are considered in preparing the Five-Year Program. The program is updated annually and must be adopted by the State Transportation Board and submitted to the Governor by June 30<sup>th</sup> of each year.

### **2.3 – Priority Programming Process**

The statutory power to prioritize individual airport and highway projects is placed on the State Transportation Board. The Priority Planning Advisory Committee (PPAC) is appointed by the ADOT Director and assists the Board in setting priorities. The PPAC is guided by several policies established by the Board.

The highway construction program is a product of input on needs from citizens, local governments, planning organizations, chambers of commerce, the business community and ADOT professionals. The PPAC must then consider these needs, which far outweigh the funds available, in establishing the Five-Year Construction Program.

The prioritization methodology consists of a rating system that compares basic criteria about each project against all other submitted projects. The system is an objective tool that incorporates several roadway characteristics. Other criteria are also used including route significance, continuity, cost effectiveness, and input from the District Engineers.

The highest ranked projects in each program category are then considered for inclusion in the construction program to the extent that funding is available. Projects that are already in the Five-Year Program are adjusted to account for construction target dates, updated construction costs, and other unanticipated factors outside of the department's control.

The Five-Year Program may contain other programs such as the MAG Life-Cycle Freeways Program that is for the construction of the controlled-access highway system funded by a one-half cent excise tax in Maricopa County.

For a more complete description of the Priority Programming Process, visit the Multimodal Planning Division pages on the ADOT website.

#### **2.4 - Statewide Transportation Improvement Program (STIP)**

The Transportation Equity Act for the 21<sup>st</sup> Century (TEA-21) required each State to submit a Statewide Transportation Improvement Program, including all highway projects in the state funded under Title 23 to be federally approved. Projects must meet the criteria established under TEA-21. Revisions to projects may require action to amend the approved STIP. The 2005 SAFETEA-LU Transportation Act reaffirmed the planning laws under TEA-21.

#### **2.5 - Design Implication**

The design of new construction or reconstruction projects should recognize the planning goals set forth by the Priority Programming Process. While full construction of the planning facility may not be warranted at project development time, the constructed project should be compatible with and be capable of being incorporated into the planned facility at a future date. Generally, this will result in the efficient and effective use of available funds. However, there are occasions where it would be prudent to deviate from the planning goals. Incompatibilities with planning goals are approved within the predesign project scoping documents.

### **3 – Application of Guidelines**

#### **3.1 – Roadway Design Guidelines**

The discussions, criteria, and policies presented in this manual are intended to guide the highway designer in exercising sound engineering judgment in the application of design parameters to the project development process.

The goal is to provide a highway which increases transportation service and safety in a manner that is consistent with its setting and which is compatible with the community and State values and plans.

The design data used for a given project should ordinarily equal or exceed the values given in this manual. However, the philosophy presented above requires consideration of and permits use of lesser values when such action to meet the needs of a project is in the best interests of the public as a whole.

Design standards have evolved over a number of years. It is not economically feasible to bring previously constructed highways into conformity with current standards. However, certain features of selected highways may be upgraded from time to time when it is feasible to do so. The standards in this document are to be applied to new construction and reconstruction. The standards do not generally apply to resurfacing, restoration rehabilitation, and minor reconstruction of existing facilities.

Standards are presented in this manual on three levels: mandatory, desirable, and optional. Mandatory standards make use of the word “**shall**” in **bold type**. Desirable standards make use of the word “should” while optional standards use “may”.

**To promote uniformity throughout the State, the use of design values lower than the mandatory standards presented in this manual shall require the written approval of the Assistant State Engineer, Roadway Engineering Group or authorized designee.**

### **3.2 – Design Exceptions/Design Variances**

Request for exceptions and variances to the range of design values presented in this document may be made during the predesign scoping phase or the design phase. Requests for exceptions or variances with supporting documentation are submitted to the Assistant State Engineer, Roadway Engineering Group for review and approval. Projects having direct FHWA oversight will require their final approval.

The “[Design Exception and Design Variance Process Guide](#)”, December 14, 2009 is to be followed for requesting Design Exception and Design Variance approvals.

### **3.3 – Other ADOT Documents**

This manual is to be used in conjunction with current editions of other ADOT manuals, specifications, and standard drawings as listed in Chapter 8, “Project Design References” of the ADOT *Project Development Process Manual*, 1995.

### **3.4 – Policy on use of AASHTO Guides**

This manual is complementary to AASHTO’s *A Policy on Geometric Design of Highways and Streets, 2011* and is to be used in conjunction with that document. AASHTO’s policies presented therein reflect general nationwide practices and are not necessarily applicable to the conditions in Arizona. Where the design values provided

in this manual differ from those presented in the AASHTO guidelines, this manual will take precedence.

Where the values in this manual cannot be achieved using good engineering practice and judgment, reduced values may be acceptable when justified and approved in accordance with [Section 3.2](#).



## CHAPTER 100

### DESIGN AND CRITERIA

#### 101 – Design Speed

##### 101.1 – General

AASHTO defines design speed as “a selected speed used to determine the various geometric design features of the roadway.” ADOT uses design speed to establish specific minimum geometric design elements for the highway segment. Design speed directly affects design elements such as curvature, superelevation, and sight distance. Other features such as pavement and shoulder width, side clearances, etc., are indirectly related to design speed.

The design speed does not define the maximum safe speed which can be maintained on a highway. The design speed for a project is considered a minimum value i.e., the highway design elements will meet or exceed the standards for the design speed.\* Further, the design standards are based upon unfavorable or near-worst-case conditions. Thus, the “maximum safe speed” under normal conditions is significantly greater than the “design speed.” Under such conditions, the majority of drivers feel comfortable at speeds greater than the design speed.

---

\*This statement applies only to projects which are covered by this manual and are new construction or major reconstruction where new horizontal and vertical alignments are implemented.

---

Because of these inherent factors of safety, design speed is separate and distinct from the posted speed limit. AASHTO provides that posted speed limits are usually set to approximate the 85th-percentile speed value as determined by measuring a sizable sample of vehicles. The speeds which drivers find reasonable and appropriate for a highway are independent of the design speed. Posted speeds are also independent of the design speed.

Thus, the design speeds for roadway projects on new alignment as discussed in this Manual are independent of the posted speed limit.

### 101.2 – Selection of Design Speed

The selected design speed should logically reflect the character of the terrain, economic considerations, type and volume of anticipated traffic, environmental factors, adjacent land use (rural or urban), and functional classification (freeway, rural arterial, etc.) of the highway.

The design speed for a project should be consistent with design speeds for adjacent highway improvement projects. Generally, the difference in design speeds between adjacent projects in similar terrain should not be greater than ten miles per hour. (Also see [Section 203](#).)

Drivers expect design speeds that are consistent for highways with similar characteristics. These expectations are independent of the functional classification of the highway. A driver expects to go slower in the mountainous terrain of the Mogollon Rim area than in the rolling terrain above the Rim. However, there is no difference in travel speed expectations between a rural divided highway and a two lane road through the open desert. Thus, it is not reasonable to automatically assign a lower design speed to a secondary highway when low traffic, topography, and lack of adjacent development would indicate that drivers are likely to travel at high speeds.

In general, as high a design speed as is feasible should be used. Higher design speeds generally increase construction and right-of-way costs. However, these costs may be offset by savings to the public through lower vehicle operating costs and reduced time of travel.

The selection of a design speed does not impose an upper limit on geometric design. Higher standards of roadway geometry may be used provided there is no appreciable increase in construction or maintenance costs and the anticipated operating speed is reasonably consistent throughout the highway project.

For the purposes of this Manual and in accordance with the AASHTO Green Book, the upper limit of low-speed design is 45 mph and the lower limit of high-speed design is 50 mph.

### 101.3 – Design Speed Standards

The following table ([Table 101.3](#)) shows appropriate values of design speeds for various conditions. Absent unusual circumstances, the design speed listed should be used. In unusual circumstances, design speeds equal to the minimum value listed in the “Green Book” may be used with proper justification and approval. Justification for using the minimum values should be based upon the criteria given in [Section 101.2](#).

Table 101.3

## Relation of Highway Type to Design Speed

| Highway Type                              | Design Speed (mph) |
|---|--------------------|
| Controlled-Access Highways                |                    |
| Level terrain*                            | 75                 |
| Rolling terrain                           | 75                 |
| Mountainous terrain                       | 65                 |
| Urban/Fringe Urban areas                  | 65                 |
| Rural Divided Highways                    |                    |
| Level terrain                             | 70                 |
| Rolling terrain                           | 65                 |
| Mountainous terrain                       | 60                 |
| Rural Non-divided Highways                |                    |
| Level terrain                             | 70                 |
| Rolling terrain                           | 65                 |
| Mountainous terrain                       | 55**               |
| Urban/Fringe Urban Highways               |                    |
| Arterial streets (C & G With Development) | 30 – 50            |
| Urban Highways                            | 30 – 60            |

\* Note: Throughout this document, level, rolling and mountainous terrain are defined as follows:

**LEVEL TERRAIN:** Any combination of geometric design elements that permits trucks to maintain speeds that equal or approach speeds of passenger cars.

**ROLLING TERRAIN:** Any combination of geometric design elements that causes trucks to reduce speed substantially below that of passenger cars on some sections of the highway but which does not involve sustained crawl speeds by trucks for any substantial distance.

**MOUNTAINOUS TERRAIN:** Any combination of geometric design elements that will cause trucks to operate at crawl speed for considerable distances or at frequent intervals.

\*\* Note: The Designer should try to achieve a 60 mph design speed if there is the expectation of future development to a 4-lane divided highway.

[Table 101.3](#) shows a range of values of design speed for urban arterial highway projects. For such projects, selection of a design speed must consider the criteria given above together with the practices of the municipality through which it passes. The designer should consider applying urban design criteria on projects adjacent to urban areas where urban development is likely prior to the project's design year.

Generally, one design speed per highway project is used. There may be more than one design speed within a given project when the highway type or terrain conditions vary within the project limits. Design speed(s) for a project are identified in the predesign scoping documents.

**Use of design speeds less than the minimum shown shall require approval from the Assistant State Engineer, Roadway Engineering Group or authorized designee.**

The design speed,  $V$ , should be shown in the project scoping documents together with traffic design data (see [Section 102.2](#)).

**Once established in the approved project scoping documents, design speed shall not be changed without the approval of the Assistant State Engineer, Roadway Engineering Group or authorized designee.**

Design speeds for traffic interchange elements are given in [Chapter 500 "Traffic Interchanges"](#).

The design speed for rural frontage roads should be 20 mph less than the mainline design speed. Urban frontage roads should be designed as Urban Arterial Streets.

## **102 – Design Traffic**

### **102.1 – Design Period**

The design of new facilities is based upon traffic projections for approximately 20 years (to the nearest 5-year increment) after construction. Operational improvement projects should be designed for current traffic volumes with consideration for future growth and the impact of other planned projects. The design period for pavement preservation projects should be as determined by the Materials Group.

### **102.2 – Traffic Design Data**

For new construction, design traffic will be derived from future year traffic projections adopted by the local regional council of governments, metropolitan planning organization, or as established by ADOT's Multimodal Planning Division.

---

Traffic data used as a basis for design should be shown in the Project Assessment Report and the Design Concept Report in the following example:

---

|               |        |     |     |
|---------------|--------|-----|-----|
| AADT (2004) = | 5,800  | D = | 60% |
| AADT (2024) = | 19,000 | T = | 10% |
| DHV =         | 1,500  | K = | 8%  |

---

Where:

- AADT (2004) is the average annual daily traffic, in number of vehicles, for the construction year;
- AADT (2024) is the average annual daily traffic, in number of vehicles, projected for the design year;
- DHV is the two-way design hourly volume projected for the design year;
- D is the percentage of the DHV in the direction of heavier flow;
- T is the percentage of trucks expected in the DHV; and
- K is the percentage of ADT expected in the design hour
- 

One set of traffic design data should be used throughout a project, except where a change in the DHV or DDHV warrants a change in the number of lanes.

**Once established in the approved project scoping documents, traffic design data shall not be changed without the approval of the Assistant State Engineer, Roadway Engineering Group or designee.**

## **103 – Highway Capacity**

### **103.1 – General Characteristics**

The capacity of a highway is a measure of the number of vehicles which can reasonably be expected to pass a given point or section of a lane or roadway during a given period of time. The design capacity is the projected maximum number of vehicles for which a highway can provide a selected level of service.

Capacity varies with a number of highway characteristics, including:

- a) Width and number of lanes.
- b) Weaving sections.
- c) Ramp terminals.
- d) Shoulder width.
- e) Horizontal alignment.

- f) Spacing and timing of traffic signals.
- g) Grades.
- h) Volume and proportion of trucks, buses, and recreational vehicles.
- i) Operating speed.
- j) Horizontal clearance.
- k) Side friction due to driveways, parking, intersections and interchanges.

Design capacity is based upon the above factors plus the desired operational level of service of the highway.

### 103.2 – Levels of Service

Level of service (LOS) is a method of describing the operating characteristics of a section of highway. Detailed descriptions of the several levels of service (A through F) are given for the four functional classifications of highway. Broadly defined, in terms of traffic flow, LOS A is associated with free flow traffic; LOS B indicates reasonable free flow; LOS C is stable operation; LOS D is lower range of stable flow; LOS E is unstable flow; and LOS F indicates breakdowns in flow.

Design levels of service **shall** be in accordance with [Table 103.2A](#). Where a range is shown, the higher level of service should be provided except where costs or environmental constraints justify the lower level of service.

A detailed discussion on design highway capacity and procedures for determining highway capacity and levels of service may be found in the *Highway Capacity Manual*.

**Table 103.2A****Relation of Highway Type to Design Levels of Service**

| Highway Type                | Design Levels of Service |
|-----------------------------|--------------------------|
| Controlled-Access Highways  |                          |
| Level Terrain               | B                        |
| Rolling Terrain             | B                        |
| Mountainous Terrain         | B – C                    |
| Urban/Fringe Urban Areas    | C – D                    |
| Rural Highways              |                          |
| Level Terrain               | B                        |
| Rolling Terrain             | B                        |
| Mountainous Terrain         | B – C                    |
| Urban/Fringe Urban Highways | C – D*                   |

\* As an alternate to level of service D, consideration should be given to pairs of one-way streets or alternative bypass routes to improve the level of service.

### **103.3 – Capacity Enhancements**

It is desirable to design for the same level of service throughout a segment of highway even though changes in highway characteristics within the segment may impact its operational capacity. The designer should look at ways to counteract any negative impacts on design level of service stemming from the highway's local operational characteristics. Countermeasures may include adding truck or passing lanes where high truck volumes and positive grades combine to substantially reduce the facility's operational capacity (see [Section 204.5](#) and [Section 209.1](#)); use of collector-distributor lanes to replace short weaving sections; elimination of driveways; providing additional shoulder width adjacent to parking; coordinating traffic signals; channelizing intersections; etc.

## **104 - Control of Access**

### **104.1 – General Policy**

Access control is achieved by regulating public access rights to and from properties abutting highways. Full access control gives preference to through traffic by providing access only through selected public roads and by prohibiting at-grade crossings or direct access from abutting property. Partial access control still gives preference to through traffic but permits some crossings at grade and some private driveway connections. Without access control, abutting properties are permitted access to the highway, but the number, location and geometrics may be regulated.

Access control generally requires the legal acquisition of rights-of-access from the abutting property owners.

Interstate, rural controlled-access and urban/urban fringe controlled-access highways are by definition fully-controlled-access highways. **Direct access to fully-controlled-access highways is prohibited without exception.**

Access to abutting properties is provided by frontage roads or streets connected to traffic interchanges. See [Section 506](#) for more specific guidance on access control requirements at traffic interchanges.

### **104.2 – Direct Access**

Traffic entering or leaving a highway via side roads or driveways has a detrimental effect upon highway capacity, operational speed and user safety. Direct access from abutting properties should be limited. In rural areas, parcels fronting only on the highway may be given access to another public road or street by constructing suitable connections if such access can be provided at reasonable cost. Where direct access is provided in rural areas, the intersections should be improved to a level consistent with design traffic volumes.

Abutting properties may have direct access to non-controlled access highways through ADOT's permitting process.

### **104.3 – Frontage Roads**

Frontage roads are provided on freeways and expressways to replace local street circulation lost by the construction of the facility. The frontage road provides access to abutting properties where access previously existed and cannot reasonably be provided otherwise. Frontage roads may also be provided when the construction of a freeway or expressway imposes unreasonable circuitry of travel, even though continuity did not exist before.

When it appears that a frontage road is warranted on the basis of access or continuity, justification should be on economic grounds. The costs of construction and acquisition of right-of-way for the frontage road should be less than the costs of providing access by other feasible means. The costs of the frontage road must also be compared against the costs of not providing access to the property and paying severance damages or acquiring the entire property.

Frontage roads are generally not constructed when the highway is on new alignment. On new alignment, property owners have no previous access rights and, except as described above, there is no justification for a frontage road. For highways constructed on existing alignments (either existing highways or existing streets) property owners may have access rights which may need to be replaced. As described above, justification for providing a frontage road should be based on economics.

From time to time, ADOT may receive requests from local governments or private interests to include frontage roads which cannot be justified by the above listed criteria. These frontage roads may be included in the construction contract under a written agreement which provides for ADOT being reimbursed for its design, construction, and right-of-way costs. Maintenance responsibilities are also outlined in the agreement.

Frontage roads do not need to be continuous between cross roads. If not continuous, local fire department criteria for cul-de-sacs may limit the length of the frontage road.

## **105 – Roadside Installations**

### **105.1 – General**

All connections to rest stops, vista points, roadside parks, maintenance yards, pullouts, truck weigh stations, truck brake inspection areas, and other public connections should be constructed to design criteria commensurate with those used for the highway. For controlled-access highways, such connections should be designed as ramps with appropriate acceleration and deceleration lanes. For rural highways and urban arterial highways, such connections should be designed as public road intersections with appropriate widening of the highway.

No more than one entrance and one exit should be provided from the highway to the facility.

### **105.2 – Rest Stops/Roadside Parks**

Rest stop and roadside park locations will be established by Roadside Development Section. Siting and layout of such facilities will be set by Roadside Development in consultation with the highway designers regarding highway engineering issues. Depending upon construction packaging, the Roadside Development Section is responsible for preparing the PS&E documents for construction between the ramp gore areas.

### **105.3 – Ports of Entry**

The need for and the location of ports-of-entry is established by the Enforcement and Compliance Division (ECD). The highway designer should work closely with ECD to determine the operational and space requirements of the facility and in laying out the proposed site.

Final plans for the facility will be the responsibility of Intermodal Transportation Division; consultants may be required to assist in preparing the architectural contract documents.

### **105.4 – Pullouts**

Pullouts may be provided for access to roadside facilities which are contiguous to non-controlled access highways. Such facilities may include historical markers, vista points, mail boxes, bus stops and weigh-in-motion stations. Pullouts may also be provided for safety checks and for slow moving vehicles to pull out of through traffic so that faster vehicles can pass.

Pullouts differ from other roadside facilities in that there is no physical separation between the pullout and the traveled way. Vehicles pull out of the traffic stream, stop for a period of time along the roadway and then return to the traffic stream. For this reason, pullouts are not appropriate on controlled access highways and should be avoided on urban highways.

Special care should be taken in the design of pullouts to provide adequate sight distance for the movements in and out of traffic. The design should also recognize the varying degrees of roadside activity associated with the different facilities and should provide an appropriate offset from the through traffic lanes.

Pullouts should be designed in accordance with the provisions for intersections in [Chapter 400](#).

## **106 – Stage Construction**

### **106.1 - General**

The terms “stage construction” and “phase construction” are often used interchangeably within the construction industry to denote the construction of a facility by parts or elements in a sequential manner. For purposes of this discussion, stage construction generally implies that the completion of a stage will result in a useable product; i.e., a bridge, a highway segment etc.

Stage construction may be used for many reasons having to do with financing and constructability issues. Typically, stage construction is used to construct the elements of a project in a continuous manner within a period of five or so years (near-term) or to construct only a part of the elements of a project, putting those elements into use on an interim basis and then completing the overall project after a number of years have lapsed.

### **106.2 – Near Term**

The primary purpose for using stage construction on a highway project is to reduce costs by facilitating maintenance of traffic through the project or by separating construction specialties. On major widening projects or when constructing a divided highway on an existing alignment, it may be desirable to construct one-half of the facility first while maintaining traffic on the existing highway, then shifting traffic to the newly constructed part and finishing the project.

On new freeway and expressway projects, it may be desirable to construct local road grade separation structures first while detouring local traffic around the bridge site. Upon completion of the bridges, the roadway contractor may use the entire project site without traffic interference.

### **106.3 – Interim Facilities**

Highway projects are designed for traffic volumes projected for a period twenty years beyond the construction of the project. On new freeway and expressway projects, there may be significant differences in traffic volumes projected for the design year and for the year of completion. Further, for highway projects serving newly developing areas, the assumptions underlying the traffic projections are subject to significant variations which may reduce the level of certainty of the projected traffic. In such cases, it is appropriate to construct an interim facility which would be adequate for conditions expected ten years after construction. The remainder of the full design could be constructed at a later date if traffic volumes so warrant.

Interim facilities should be designed and constructed to be readily incorporated into the final project when constructed. The design of the ultimate facility should be completed in order to insure complete compatibility with the interim design, e.g. divided freeways should include design of future median lanes and median barriers to insure compatibility with future barrier design and profile as well as drainage of the future pavement. Further, the interim facility should not preclude the economical construction of the final project. Examples of interim projects might include providing extra wide medians to accommodate future additional lanes; constructing one-half of a divided highway; constructing an ultimate freeway with at-grade intersections rather than a freeway with traffic interchanges; constructing frontage roads of a controlled-access freeway for interim mainline traffic. Determination of stage construction/interim facility construction is included in the project scoping documents.

---

## **107 – Bicycle and Pedestrian Facilities**

### **107.1 – Bicycle Facilities**

It is ADOT's policy to develop a transportation infrastructure that provides safe and convenient bicycle access. ADOT further advocates that bicyclists have the right to operate in a legal manner on all State highways including fully controlled-access highways except where specifically excluded by administrative regulation and where posted signs give notice of a prohibition. The *ADOT Bicycle Policy, 2007* should be utilized to accommodate bicycles in the design of new facilities. The *ADOT Bicycle Policy* incorporates the *AASHTO Guide for the Development of Bicycle Facilities, 1999* as the appropriate design guide.

### **107.2 – Pedestrian Facilities**

It is ADOT's policy to provide a transportation infrastructure that provides safe and convenient pedestrian access. The *AASHTO Guide for the Planning, Design, and Operation of Pedestrian Facilities, 2004* provides guidelines for the design of pedestrian facilities.

*A) Sidewalks:* Sidewalks are normally not constructed as a part of a highway project except as provided below. In urban areas, the highway cross section should provide space for sidewalks to be constructed by others in the future.

Exceptions:

- a) ADOT will construct and pay for sidewalk to replace existing sidewalks along a State highway or a local street which were removed as a part of an ADOT project.
- b) ADOT may construct additional sidewalks, over and above paragraph a), along local streets or along an urban arterial highway at the request of the local government, provided there is an agreement with the local government to pay ADOT's additional costs for design, construction and right-of-way. Agreements with local governments for the maintenance of the sidewalks must be executed before advertising the project for bids. Maintenance agreements will normally be the responsibility of the District Engineer; early notification to and coordination with the district is essential.
- c) ADOT will construct and pay for sidewalks on local street grade separation structures where there is a clear indication of future pedestrian traffic along the street after construction of the highway.

*B) Grade Separations:* Warrants for pedestrian grade separations are based on a study of the present and future needs of a particular area. Each situation should be considered on its own merits. The study should identify pedestrian generating sources in the area, pedestrian crossing volumes, vehicular traffic volumes at peak pedestrian times, type of highway to be crossed, socioeconomic and cultural factors, adjacent

crossing facilities, zoning and land use in the area, type and age of pedestrians to be the primary users, and circuitry of travel without the grade separation.

Special consideration should be given to school crossings. Grade separation structures may be warranted even with very low volumes of student pedestrians. Established pedestrian patterns should be maintained across highway routes. If adjacent vehicular crossings are inadequate for the type and age of pedestrians, then grade separation structures should be considered.

To warrant construction of a pedestrian grade structure, all six of the following criteria must be satisfied:

- a) High vehicular volumes conflict with high pedestrian volumes, constituting an extreme hazard; **and**
- b) Modification of school routes, busing policies, campus procedures, or attendance boundaries to eliminate the need for a crossing is not feasible; **and**
- c) Physical conditions make a grade separation structure feasible from an engineering standpoint, including pedestrian channelization to insure usage of the structure; **and**
- d) Pedestrian movements can be restricted for at least 600 ft on each side of the proposed overpass; **and**
- e) A demonstrated problem exists that simpler, more economic solutions have failed to remedy; **and**
- f) The anticipated benefits to be derived from the overpass clearly outweigh the costs.

Pedestrian overcrossings are the preferred type of grade separation structure. If conditions are unfavorable for an overcrossing, undercrossings may be provided with special attention given to safety issues including width, lighting, visibility, drainage and entrance/exit conditions.

### **107.3 – Handicap Access**

The “Americans with Disabilities Act and Architectural Barriers Act Accessibility Guidelines, July 23, 2004”, published by the US Access Board and as adopted by the US Department of Justice and the US Department of Transportation is the current ADA standard for design of new facilities. The US Access Board has also developed the “Proposed Accessibility Guidelines for Pedestrian Facilities in the Public Right-of-Way, July 26, 2011” which may be used for additional design guidance.

## **108 – Contractor’s Yard and Plant Site**

### **108.1 – General**

A contractor needs a base of operations on or near the job site to provide space for field offices, equipment and material marshaling yards, and material plants. The requirements for a base of operations are dependent upon an individual contractor’s approach to the project. For this reason, the selecting and securing of yard and plant sites are left to the contractor.

From time-to-time, certain projects may have requirements which substantially restrict the contractor’s options in selecting and securing an appropriate base for project operations. Such situations may occur where the project is predominately located in government controlled lands, on Native American Indian Reservations, heavily developed urban areas or in areas of exceptional environmental sensitivity. It is in the Department’s best interests that appropriate yard and plant sites are made available to the contractor where lack of suitable sites and/or environmental clearance issues could prevent the contractor from obtaining a site in a timely manner.

The need for the contractor’s yard and plant sites should be considered in the scoping document where it appears there are significant constraints. District construction engineers should be consulted in establishing sites available to the contractor.

Environmental clearances are required on any site so designated. Evaluation and selection of potential sites should be coordinated with Right-of-Way Group, with Environmental Planning Group and with district construction engineers. Environmental clearance should be started early in the project development process to permit timely completion. The contractor is permitted to use the approved site only for the designated project.

## **109 – Material and Disposal Sites**

### **109.1 – Material Sources**

ADOT Standard Specifications provide for three classifications of material sources: ADOT furnished, contractor furnished and commercial. This section covers only ADOT furnished sources.

Where it can be reasonably assumed that all materials can be economically obtained from commercial sources, there is no need to identify Department furnished sources.

When required for the project, ADOT will identify available material sources for borrow if appropriate sources can be identified and if it is believed that use of the sources can be economically beneficial to the project.

It is ADOT's practice to avoid specifying mandatory material sources. Mandatory sources should be provided only if a clear economic advantage will accrue to the State through the use of the single source.

ADOT's policy requires environmental clearance of any site used as a material source. Potential sites, if needed, should be identified early so that the environmental clearance process can be completed in a timely manner.

In addition to environmental clearances, potential material sources need to have geotechnical explorations and tests made to establish the character and extent of the site. ADOT Right-of-Way Group is responsible for securing rights for use of the source including ingress and egress and for negotiating royalties to be paid, if any.

All available information regarding the source, including exploration and test results, is located at the Materials Geotechnical Design Office. Contractors and others may review these files upon request. It is important that the test results, and any other material given the contractor, be factual with no opinions, interpretations, or conclusions. The contractor is to be responsible for evaluating the test results in light of their methods and means of constructing the project, for obtaining additional tests if necessary and for determining the desirability of using the ADOT-furnished source.

### **109.2 – Material Sources in Flood Plains**

Arizona restricts the use of material sources situated in the 100-year floodplain of any stream or watercourse, and located within one mile upstream and two miles downstream of any highway structure or surfaced roadway crossing.

There are no ADOT-furnished material sources within restricted use areas, except that material sources located on Native American Indian Reservations may be considered for use on an individual basis.

Consideration of material sources within the restricted area of streams on Native American Indian Reservations is to be based on a review of applicable land use plans, floodplain management plans, environmental plans, applicable laws and regulations pertaining to Native American Indian Reservations, and an engineering analysis of the effects on any highway facility or structure. For ADOT furnished material sources, Right-of-Way Group will negotiate and obtain all permits, licenses, and approvals from the Native American Tribal Council.

### **109.3 – Disposal Sites**

It is the policy of ADOT not to specify mandatory sites for the disposal of surplus excavated materials unless a particular site is required for environmental reasons or the site is found to be the most economical for one or more projects.

If a site is to be specified, the Right-of-Way Group will negotiate and obtain all permits, property rights, licenses and/or approvals required for the site. Environmental Planning Group will be responsible for preparing environmental clearances. Early notification of and coordination with Right-of-Way and Environmental Planning Group is essential to allow right-of-way and environmental clearances to be obtained in a timely manner in accordance with the *Highway Development Process Manual*.

### **109.4 – Salvage Material**

From time-to-time, it may be in the State's best interests to retain salvage material from a project for its own use or for the use of other public agencies. The disposition of such salvage material is to be coordinated with the District Engineer. The district will be responsible for obtaining any necessary clearances or agreements.

---

## **110 – Scenic/Aesthetic Values**

### **110.1 – Parkway/Historical and Scenic Roadways**

The State Transportation Board is authorized to designate any highway or area as a parkway or a historic or scenic road. Parkway, historic, and scenic designated roads on the State highway system are provided on the Environmental Planning Group's website. By law, the following definitions apply:

- Parkway is an area along either or both sides of a highway, street, road or route which was designated such for the purpose of protecting geographic, natural flora or scenic values;
- Historic road is a highway, street, road or route which was designated such and that has historical or cultural importance in the settlement and development of Arizona; and
- Scenic road is a highway, street, road or route which was designated such and is in a scenic area.

Scenic and aesthetic values should be major considerations in the design of parkways, historical, and scenic roadways. Designated parkways, historic or scenic roads may have approved corridor management plans that specify the actions, procedures, operational practices and administrative responsibilities and strategies to manage and protect the resources of a designated road. To insure the protection and enhancement of the special features which warrant the designation of historic roads, parkways and scenic roads, exemptions may be made from the standards normally applied to the construction and maintenance of the roads. The minimum criteria used for the construction and maintenance of these roads must reasonably provide for the safety and service of the traveling public. **Exceptions to the normal design criteria shall have the approval of the Assistant State Engineer, Roadway Engineering Group.**

**State highways crossing National Forest lands shall be designed in accordance with the scenic and aesthetic guidelines presented in the ADOT and U.S. Forest Service [Guidelines for Highways on Bureau of Land Management and U.S. Forest Service Lands 2008](#).** To a lesser degree, scenic and aesthetic values should be considered in the design of all State highways.

### **110.2 – Scenic Values**

Arizona is a land of startling beauty and scenic wonders. With the Grand Canyon, Lake Powell, and the Painted Desert in the north, the Red Rocks, Mogollon Rim, Salt River Canyon, and White Mountains in the central areas, and the Sonoran Desert and the Chiricahua and Huachuca Mountains in the south, Arizona is filled with scenery that impresses tourists and residents alike.

The scenery and the climate attract tourists from all over the world each year and tourism is a major factor in Arizona's economy. Arizona's highways should be designed to showcase its natural beauty.

On new alignments, the Environmental Planning Group should be consulted early in the development process to assist in identifying scenic opportunities along the route. Consideration should be given to views from the road, views from vista points and views of the highway (as seen by project neighbors). Once identified, the highway designers should work closely with Environmental Planning Group personnel to determine feasible ways to present and enhance the scenic views.

Throughout the highway development process and consistent with sound engineering principles, safety and economies of construction, consideration should be given to:

- a) Locating the highway such that the new construction will preserve the natural environment and provide opportunities for scenic enhancement.
- b) Designing the horizontal and vertical alignments of the highway to fit the terrain of the area and minimize the impacts of excavation and embankment.
- c) Minimizing the destruction of desirable vegetation such as trees, specimen plants, and native species. When feasible, the highway should be aligned to miss stands of native trees. Trees and desirable shrubs within the construction limits should be preserved for replanting.
- d) Maintaining the visual importance of removed shrubs and trees by reflecting the original massing and size in replacement plantings while maintaining a clear view of the road ahead free of trees and bushes restricting horizontal sight distance and providing clear recovery areas.
- e) Selectively thinning or removing existing trees and shrubs to open up scenic vistas or provide a natural looking boundary between cleared areas and the surrounding vegetation.
- f) Wherever feasible, provide wide medians and independent alignment roadways on multilane roadways to increase scenic interest.
- g) Flattening slopes, rounding slope tops, and providing vegetation to soften the lines of construction.
- h) Providing bridges, tunnels or walls in lieu of massive cuts and fills where such structures are reasonably economical.
- i) Providing architectural treatment such as rustication and patterned surfaces to walls and bridges to improve their appearance. Painting or color treating structural surfaces to complement or contrast with their natural surroundings adds interest to these structures.
- j) Grading interchange areas to provide graceful, natural looking contours which blend with the local terrain while observing safety guidelines for vehicle recovery zones.

Scenic values are not limited in application to rural areas. Both the manmade and natural environments provide scenic opportunities in the urban areas; each should be given full consideration in the design of urban highways.

### **110.3 – Landscape and Environmental Design**

AASHTO's publication, *A Guide for Transportation Landscape and Environmental Design*, states that "...Landscape and environmental design can help to increase the benefits that accrue from the construction, operation and maintenance of transportation facilities, and can also help to reduce or eliminate the adverse impacts of these facilities."

The objectives of landscape and environmental design are:

- Conservation and preservation of sensitive land and water areas;
- Enhancement of project compatibility with existing and potential land use;
- Enhancement of project visual quality;
- Mitigation of adverse environmental impacts; and
- Enhancement of highway safety for the traveling public.
- Provide a low maintenance facility.

### **110.4 – Community Values/ Context Sensitive Solutions**

Context Sensitive Solutions (CSS) is a relatively new concept in highway planning, design, construction and maintenance. CSS is a process that recognizes the need to consider highway projects as more than just transportation but as integration with community values regarding purpose and need whereby the overall solution balances safety, mobility, and preservation of scenic, aesthetic, historic, and environmental resources.

CSS or Context Sensitive Design are terms used interchangeably and describe a collaborative, interdisciplinary approach in which citizens are part of the design team.

Some design personnel perceive that the application of CSS may result in a conflict or compromise of established design criteria and guidelines and may result in a decrease in the level of safety provided with a corresponding increase in exposure to tort liability. This perception is not supported by the AASHTO CSS process espousing that flexible design solutions are accomplished within established design parameters and approaches.

The AASHTO *"A Guide for Achieving Flexibility in Highway Design"* provides the concepts and approaches to CSS, context sensitive design, and flexibility in highway design. In addition the FHWA *"Flexibility in Highway Design"* publication provides complimentary guidance. These documents describe a process and concepts but do not prescribe best practices.

ADOT endorses the concept of CSS and identifies in the predesign stage of a project or study the need for implementation of the CSS process.

---

## **111 – Coordination With Agencies**

### **111.1 – Local Governments**

- a) *General:* ADOT interacts with local governments in the development, construction and operation of the State highway system; and in the administration of State and Federal-aid funds granted to the local governments.
- b) *State Highways:* Day-to-day coordination with local governments throughout the project development stage is the responsibility of the Project Manager assigned to the project. ADOT's *Project Development Process Manual* details the scope of the coordination with the local governments. The appropriate District Engineer is responsible for coordination with the local government throughout the construction, operation, and maintenance phases.

For projects involving joint efforts between ADOT and a local government, clear lines of responsibility for work scope and shared costs will be identified in a Joint Project Agreement. Joint Projects Administration Group is responsible for the preparation and execution of these agreements.

- c) *State and Federal-Aid Projects:* The Local Government Section is responsible for the administration of direct Federal and State-aid to the local governments for highway projects. The "Intermodal Surface Transportation Efficiency Act of 1991 (ISTEA, H.R. 2950) provides for the delegation of partial or full Certification Acceptance to local governments that meet certain criteria. ADOT may also permit local governments to self-administer certain phases of the work. ADOT will administer projects or phases of projects which do not fall under local government Certification Acceptance and/or self-administration. On such projects, coordination with the local government will be by Local Government Section.

### **111.2 – State Agencies**

- a) *State Parks Department:* ADOT is responsible for providing design, design review, and construction engineering services to the State Parks Department for roads connecting the parks to the State roadways, roads within the parks, and other on-site facilities. The Roadside Development Section provides liaison between ADOT and the State Parks Department.
- b) *Other State Agencies:* ADOT has occasion to interact with other State agencies from time-to-time either in support of their activities or by requiring their input or approval on an ADOT project. The Environmental Planning Group provides liaison between ADOT and the other State agencies on environmental issues. The Joint Projects Administration Group coordinates with the Attorney General's Office on project agreements with other

agencies. On other matters, coordination with other State agencies will be through the State Engineer's Office or a designated representative.

### **111.3 – Federal Highway Administration**

The Federal Highway Administration (FHWA) is responsible for administering the Federal-Aid program for funding transportation projects. The FHWA, therefore, must be satisfied that all Federal regulations, policies, and procedures have been followed on projects which are to have Federal funding.

For certain classes of projects, the FHWA has been authorized by Congress to accept a project for funding based upon a certification that the project meets Federal funding requirements. This process is called "Certification Acceptance". Certification Acceptance is described in Section 2.8.1.1 of the ADOT [Project Development Process Manual](#) and in the Certification Acceptance Procedures Agreement between ADOT and the Federal Highway Administration dated September 8, 1994.

In 1997 ADOT and FHWA formed the ADOT-FHWA Operating Partnership Agreement between ADOT and the Arizona Division of FHWA regarding the administration of Federal-aid transportation projects in the State of Arizona. This agreement was superseded in March 2010 by *The FHWA and ADOT Stewardship and Oversight Agreement for Arizona*. This agreement outlines each party's responsibilities for administration of projects on the National Highway System. Federal-aid projects not on the National Highway System may follow State policies and procedures in the same manner as State funded projects, except that Federal contract procedures will apply. This document is a working document and may be revised and updated from time to time.

### **111.4 – U.S. Forest Service (USFS) and Bureau of Land Management (BLM)**

ADOT, USFS and BLM, in conjunction with FHWA have prepared procedures for developing highway projects on Forest Service and BLM lands. These procedures are set forth in two Memorandums of Understanding (MOU) regarding construction, operation and maintenance of highways in Arizona crossing national forest system and BLM lands. One MOU is with ADOT-FHWA-USFS and the other MOU is with ADOT-FHWA-BLM.

ADOT, USFS, BLM and FHWA have prepared a manual to guide the design, construction and maintenance of Arizona highways on National Forest and BLM lands. The [Guidelines for Highways on Bureau of Land Management and U.S. Forest Service Lands, 2008](#) applies to roadways crossing National Forest and BLM lands that are designed, constructed and maintained by ADOT. These roadways cover the full range of highway classifications from Interstate to local roads and streets. The MOUs are included in the *Guidelines* appendices.

### 111.5 – Other Federal Agencies

ADOT interacts with other Federal agencies primarily on environmental issues. Liaison on these issues will be provided by the Environmental Planning Group. Liaison on other matters will be by the State Engineer's Office or a designated representative.

### 111.6 – Indian Tribes

A number of the State roadways pass through Native American Indian Reservation lands. These lands have been set aside for the tribes by treaties with the Federal government. ADOT's right-of-way on these lands is through easements negotiated with the Indian tribes. These easements may impact the design of the highway covered by the easement. The roadway designers should work closely with the Right-of-Way Group and the State Engineer's designated representative in determining any constraints on roadway design for projects through Indian lands.

### 111.7 – Private and Public Utilities

*Relocation Costs.* ADOT will pay the design and construction costs of utility relocation/modification which are due to a State highway project if the private or public utility has prior rights to its location.

Further, ADOT will pay for local entity utility relocation design and construction costs when all the following conditions occur:

- ADOT takes over an existing highway or street right-of-way belonging to a local entity; **and**
- A local entity has utilities in the right-of-way at the time of ADOT's take over; **and**
- It becomes necessary to adjust or relocate these utilities due to modification or improvement of ADOT's highway.

The Utility and Railroad Engineering Section (U&RR) is responsible for coordinating utility relocation and clearances on all projects. The roadway designer should work with the U&RR staff throughout all stages of a project to obtain needed information from the utility and railroad companies; to transmit design plans for verification of utility locations, identification of conflicts and development of relocation plans including need for potholing services; and to negotiate agreements for relocation of utilities having prior rights and for highway construction on railroad right-of-way.

## **112 – Maintenance of Traffic**

### **112.1 – General**

The safety and convenience of pedestrians, motorists and construction workers are major concerns throughout the development of a highway project. Design plans and specifications must be analyzed at an early stage to determine what measures need to be taken to warn and guide the public through the construction project. This analysis should recognize traffic volumes, the proposed project construction sequence, including structures, and work site space and access requirements. The analysis should be the basis for developing traffic control plans.

Generally, traffic control plans will be prepared by the Traffic Engineering Group for inclusion in the PS&E. These plans require close coordination among and between designers in Traffic Engineering, Structures and Roadway Engineering Group and District construction engineers.

### **112.2 – Traffic Control Plans**

A formal Traffic Control Plan (TCP) is required to be included in the plans, specifications and estimates (PS&E) for all Federal-aid projects. Other construction projects should also have a TCP. These plans may range in scope from a very detailed TCP for a specific project or only specifications referring to standard plans. The degree of detail in the TCP will depend upon the complexity of the project and on the interaction of traffic needs and construction activities.

Traffic control plans should be consistent with the *Manual on Uniform Traffic Control Devices*, current ADOT adopted edition including any ADOT amendments. The traffic control plans should include the use and placement of traffic control devices required for each stage of the project and signing, marking and lighting for detours.

Traffic control plans should also include the location of temporary sidewalks in accordance with the policies given in [Section 107](#).

The designer should review the accessibility to existing businesses or residences as they are affected by temporary detours or construction activities. Special signing may be necessary to direct traffic to businesses where the normal access points have been disrupted or altered. Additionally, the special provisions should include instructions

pertaining to the maintenance of local traffic access supplementing directions noted on the traffic control plans.

The requirements for traffic control plans are available through the Traffic Engineering Group.

It is recognized that provisions for traffic control are often dependent on the way the contractor chooses to prosecute the project, and the designer may have to make some assumption as to the staging or sequence of the contractor's operations in order to develop specific temporary traffic control plans. Traffic control plans in the contract documents should be based upon a workable construction sequence and traffic control staging. ADOT's Standard Specifications permit the contractor to develop and submit for approval alternate traffic control plans that meet the requirements of the Traffic Control Manual and the intent of traffic control design in the project contract documents.

### **113 – Environmental Considerations**

#### **113.1 – Stormwater Regulations for Construction Activities**

- a) *General:* The Environmental Protection Agency (EPA) issued stormwater permitting regulations to comply with provisions of the Water Quality Act of 1987 which required discharges associated with industrial activity and for discharges from certain municipal sewer systems.

In developing its stormwater regulations, EPA determined that construction is an industrial activity subject to National Pollution Discharge Elimination System (NPDES) requirements. According to EPA and the Arizona Department of Environmental Quality (ADEQ), runoff generated from construction activity "...has potential for serious water quality impacts and reflects an activity that is industrial in nature." The regulations issued by EPA and ADEQ require an agency working on a project that disturbs one or more acres of land to obtain an NPDES or AZPDES general permit if stormwater (rain or melted snow) will run off from the construction site into a drainage system (pipe, ditch, fissure, storm sewer, or other conveyance) or into the waters of the U.S.

ADOT has obtained coverage under a general permit for highway construction activities. The EPA's or ADEQ's general permit requires that a Notice of Intent (NOI) must be submitted at least 48 hours prior to the commencement of construction of a new storm water discharge. Among other items, the NOI is to contain a certification that the stormwater pollution prevention plan for the project is in compliance with approved State or local sediment and erosion plans or stormwater management plans.

The Roadside Development Section is responsible for the construction stormwater program and developing standard details and special provisions for for Best Management Practices (BMP's) to be implemented as outlined in the

ADOT Erosion and Pollution Control Manual. These include several typical BMP's such as silt fences, mulching, and temporary dikes. Also included are the contractor's "good housekeeping" procedures such as proper solid waste management and chemical storage.

Separate Notices of Intent are prepared and submitted by the ADOT resident engineer and the contractor as are separate Notices of Termination at the close of construction.

- b) *Construction Documents:* The design of temporary and permanent sediment and erosion control measures is an integral part of the highway design process. Highway designers will work closely with ADOT's erosion control specialists during the early stages of plan preparation to develop a conceptual erosion control plan.

District resident engineers will review the conceptual erosion control plans with the highway designers and the erosion control specialists at the Stage III submittal to determine the need for erosion control measures to be incorporated into the plans.

The district resident engineers, the highway designers and the erosion control specialists will review the construction plans at the Stage IV submittal to:

- Review the proposed permanent erosion control measures; and,
- Prepare a temporary erosion control plan for construction activities. The plan should include those BMP's required to control erosion during the different stages of construction. The BMP's should be included in the construction documents.

### **113.2 – Waters of the United States**

Corps of Engineers "404" Permits may be required for placement of embankments or structures within the waters of the United States. [See Section 602 – Legal and Statutory Requirements.](#)

### **113.3 – Water Quality Certification**

Section "401" Water Quality Certification may be required in addition to the "404" permit. The Environmental Planning Group is responsible for obtaining required "401" permits. Technical assistance should be provided as necessary from the design team.

### **113.4 – Contaminated Sites**

The preferred option regarding contaminated sites is avoidance.

During the early stages of project development, suspected significantly contaminated sites within the project area should be identified. At this early stage, Environmental Planning Group should be contacted to initiate studies to determine if the identified/suspected contaminated sites are within the right-of-way for a proposed alignment and if so, to what extent the contamination will affect the alignment.

Unless an alternative can be ruled out of consideration and all property required for right-of-way can be prejudged to have negligible potential for contamination, evaluations are necessary to assure contaminated sites are identified, properly assessed, and remediated or avoided where possible.

Historic land uses which carry heavy presumption of contamination include industrial areas, chemical storage facilities, fueling station or landfill sites.

The project development staff should work closely with the Environmental Planning Group in evaluating the potential for contaminated sites.

### **113.5 – Wetlands**

It is ADOT's policy to ensure that transportation facilities and projects are planned, constructed and operated while protecting, preserving, and enhancing Arizona's wetlands to the fullest extent practicable.

Wetlands generally include bogs, swamps, marshes, and like areas. Where wetlands are encountered in a highway project, the designer should contact Environmental Planning Group to assist in identifying and quantifying the wetlands, and to evaluate and determine appropriate mitigation measures.

### **113.6 – Air Quality**

The Environmental Planning Group has the responsibility for evaluating the impact of a highway project upon air quality — particularly carbon monoxide (CO) and suspended particulate matter (including dust and PM<sub>10</sub>, particulates of 10 microns or less diameter). Since the air quality evaluation may require extensive analysis, the Environmental Planning Group should be involved early in the development process.

The air quality evaluation may identify the need for mitigation measures to be incorporated into the project design, construction or operations. In some areas of the State, the prevalent air quality is such that standard mitigation measures have been developed for general project use. These measures are included in the general construction specifications, the stored specifications or the Roadway Design Policies and Procedures (Appendix A).

### **113.7 – Noise Abatement**

The Environment Planning Group also has the responsibility for evaluating the impact of highway noise on all State and federally funded projects. A noise analysis is performed to determine current and projected noise levels. Recommendations for noise abatement are made as needed to comply to the ADOT Noise Policy and the Federal Guidelines for highway noise.

### **113.8 – Cultural Resource Preservation**

The ADOT Environmental Planning Group is responsible for insuring that all construction projects consider the effects on significant cultural resources. Cultural resources can be historic bridges, buildings, roads, archaeological sites or Traditional Cultural Places.

The responsibilities are threefold:

- 1) Cultural Resource Management – Management of historic places (prehistoric, historic and traditional cultural properties) within ADOT's ROW and to consider such places in compliance with environmental and historic preservation laws.
- 2) Historic Preservation - Identification, evaluation, recordation, documentation, curation, acquisition, research, interpretation, conservation, education and training in regard to cultural resources.
- 3) Compliance – Provide cultural resource compliance with various State and Federal laws, regulations, standards, and guidelines in order to manage the project impact on cultural resources and to be integrated into the larger environmental documents.

The basis for these requirements is the National Historic Preservation Act (NHPA) of 1966 and the Arizona State Historic Preservation Act (SHPA) of 1982. The NHPA regulations require that for all Federal undertakings, which include projects on Federal land, the use of Federal funds, or the granting of a Federal permit, the agency official must identify significant cultural resources and insure that proper treatment of these resources occur prior to any undertaking. For projects that are federally funded, ADOT acts as agent for the Federal Highway Administration. The NHPA also applies to projects that occur on Federal lands, including those on USDA Forest Service and the Bureau of Land Management.

ADOT must also comply with the SHPA for all other actions undertaken by the State including projects on ADOT-owned land, private land, and land owned by the Arizona State Land Department for any project using State funds. ADOT Standard Construction Specifications require all contractors to submit environmental analyses for proposed commercial material sources, including archaeological survey.

### **113.9 – Threatened or Endangered Species**

All highway projects are evaluated to determine if the proposed construction will impact any threatened or endangered species or their critical habitat. This is under the authority of the U.S. Fish and Wildlife Service unless the project occurs within the White Mountain Apache Reservation. If there are any impacts to any species or their habitat, a Section 7 consultation will be required with the U.S. Fish and Wildlife Services for their concurrence or measures to protect these species or their habitat.

#### **113.10 – Section 4(f)**

If a highway construction project is federally funded and impacts a publicly owned park, recreation area, or wildlife and waterfowl refuge, or any significant historic site, a Section 4(f) evaluation must be performed. The Federal Highway Administration will not approve the use of these lands for highway purposes until it has been determined that there are no feasible and prudent alternatives. Any proposed construction must include all possible mitigation to minimize harm to the property resulting from the proposed use.

#### **Section 113.11 – Sole Source Aquifers**

A sole source aquifer (SSA) supplies 50% or more of the drinking water for a designated area. The Environmental Protection Agency has established a program for protection of these areas under the Safe Drinking Water Act. The two SSAs identified in Arizona are the Upper Santa Cruz & Avra Basin and the Naco-Bisbee SSA. The program requires an EPA review to determine that there will be no threat of aquifer contamination or creation of hazards to the public health. A memorandum of understanding between the EPA and FHWA specifies the review procedures for projects funded by FHWA. The Environmental Planning Group has the SSA area maps and is responsible for coordination and review of projects located within SSAs. Technical assistance should be provided as needed from the design team.

## **114 – Value Analysis**

### **114.1 – Policy**

Good management of limited financial resources make cost effective projects an important objective of the State Highway Program. Value analysis is a proven method for reducing project costs while maintaining or improving the quality of the project.

Value analysis is considered for projects in the ADOT 5-Year Program and is applied on those projects which show the potential for substantial benefits from the application of value analysis.

Development personnel are encouraged to consider projects from a value perspective and to suggest value studies where appropriate.

Candidate projects for value analysis should be identified in the predesign stage of the development process. Alternatively, projects may be recommended for study at any time up to the completion of Stage II Plans.

### **114.2 – Implementation**

Procedures for implementing the value analysis process are presented in the ADOT *Project Development Process Manual*.

## **115 - Freeway Management System (FMS)**

The ADOT Transportation Technology Group (TTG) deploys technology to improve ground transportation in Arizona called Intelligent Transportation Systems (ITS). ITS deployments on urban highways are called the Freeway Management System (FMS). The FMS consists of communications, electronics, and information processing to enhance safety, capacity, and emergency response.

Projects being scoped and designed on urban freeways must coordinate efforts with the TTG Group to evaluate and incorporate FMS system requirements and modifications into the project planning and design.

[FMS Design Guidelines](#) have been developed to assist design personnel to incorporate the basic elements of FMS in their designs and specifications.

## CHAPTER 200

### ELEMENTS OF DESIGN

#### 201 - Sight Distance

##### 201.1 - General

Sight Distance is one of the most critical aspects of highway safety because it is the length of highway visible to the driver.

Sight distance addresses the needs of drivers to safely control their vehicles to avoid striking an unexpected object on the traveled way (stopping sight distance - SSD); to safely occupy the opposing traffic lane while overtaking and passing another vehicle on a two-lane road (passing sight distance - PSD); and to have time to make prudent decisions at complex locations on the highway (decision sight distance - DSD and intersection sight distance - ISD. See [Chapter 400](#))

Stopping sight distance is the minimum sight distance to be provided on all highways and is to be provided for all elements of interchanges and intersections at grade, including private points of access. Passing sight distance is applicable to two-lane rural highways and should be provided at frequent intervals and for substantial portions of their length. Decision sight distance is used where there is a high probability for driver error in information reception, decision-making, or control actions.

Sight distance requirements are determining factors in establishing the degree of horizontal curvature and the lengths of vertical curves. In determining geometric requirements to accommodate stopping sight distance, the height of driver's eye is assumed to be 3.5 ft and the height of the object to be seen by the driver is assumed to be 2.0 ft which is equivalent to the taillight height of a passenger car. See [Sections 203](#) and [204](#).

##### 201.2 - Stopping Sight Distance

The minimum stopping sight distance is the sum of the distance a vehicle travels during brake reaction time and the distance required to stop the vehicle. Brake reaction distance is dependent upon the driver's reaction time to an unexpected situation. Braking distance is a function of the friction between tires and pavement, travel speed, and roadway grade. Friction is a function of tire and pavement conditions and speed. Stopping distance increases on a downgrade and decreases on an upgrade, as measured in the direction of traffic.

ADOT uses a graph ([Figure 201.2](#)) to relate minimum stopping sight distance with design speed and grade. A deceleration rate of  $11.2 \text{ ft/s}^2$  is utilized as documented in the Green Book.

In [Figure 201.2](#),  $V_D$  is the design speed in miles per hour. Grades (G) are expressed as percent. The minimum stopping sight distances for a given design speed as read from the graph are equivalent to the values suggested by AASHTO. The formula can be utilized to obtain exact values of stopping sight distance.

For undivided roadways with a common profile gradeline, the value of "G" should be the maximum grade of a vertical curve or the value of the grade between vertical curves. Minimum required sight distance should be determined assuming the grade is negative.

For one-directional roadways with an independent profile gradeline, the grade value used for "G" should retain its positive (up) or negative (down) sign as determined by the direction of travel.

Minimum stopping sight distances shown in [Figure 201.2](#) are applicable to all functional classifications of highways.

### **201.3 - Passing Sight Distance**

Passing sight distance comprises four elements: an initial maneuver distance, opposing lane occupancy distance, clearance length, and opposing vehicle travel distance. AASHTO has documented the derivation of empirical values for minimum passing sight distance requirements<sup>1</sup>. These minimum values, related to design speed are given in [Table 201.3](#) and are to be applied to all two-lane highways. In addition to geometric considerations, the designer should analyze traffic volumes to determine whether there will be sufficient gaps in the oncoming traffic stream to allow the pass maneuver.

Passing sight distance should be provided at frequent intervals along rural two-lane highways. Within a corridor, the minimum passing sight distances desirably will be provided over at least 60 percent of the length in level terrain, 40 to 80 percent in rolling terrain and 20 to 60 percent in mountainous terrain. Whenever possible, passing sight distances significantly in excess of the minimums should be provided.

It should be recognized that meeting passing sight distance requirements on vertical curves will require longer and more costly vertical curves than will be necessary to meet stopping sight distance requirements. In rolling and mountainous terrain, it is often more economical to provide intermittent auxiliary passing lanes than to provide the longer vertical curves required by passing sight distance. See [Section 209.1](#).

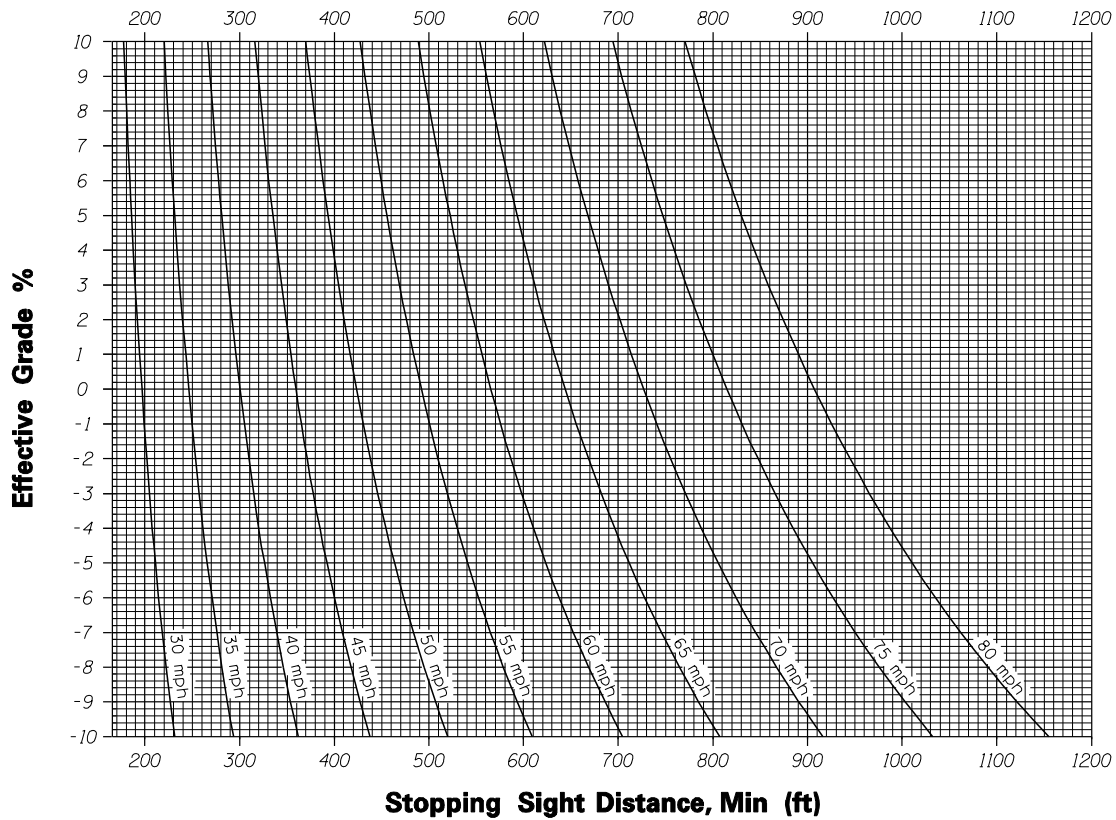

$$SD_S = 1.47 \times V_D \times t + \frac{V_D^2}{30 \left( \frac{a}{32.2} \pm G \right)}$$

Where:

- $SD_S$  = Stopping Sight Distance, Min (ft)
- $V_D$  = Design Speed, mph
- $a$  = Assumed Deceleration, 11.2 ft/sec<sup>2</sup>
- $G$  = Effective percent of Grade Divided By 100
- $t$  = Assumed Brake Reaction Time, 2.5 Sec.

Modified AASHTO EQ 3-2 + AASHTO EQ 3-3

$SD_S$  = Distance traversed during the brake reaction time plus distance to bring the vehicle to a stop on a grade.

80 mph shown for information purposes only.

**RELATION OF STOPPING SIGHT DISTANCE TO DESIGN SPEED AND EFFECTIVE GRADE**  
**FIGURE 201.2**

| <b>TABLE 201.3</b>   |                                     |
|--|-------------------------------------|
| <b>Minimum Passing Sight Distance for Given Design Speed</b> |                                     |
| DESIGN SPEED (mph)   | MINIMUM PASSING SIGHT DISTANCE (ft) |
| 30   | 1,090                               |
| 40   | 1,470                               |
| 45   | 1,625                               |
| 50   | 1,835                               |
| 55   | 1,985                               |
| 60   | 2,135                               |
| 65   | 2,285                               |
| 70   | 2,480                               |
| 75   | 2,580                               |

See AASHTO Exhibits 3-5 and 3-7

Passing Sight Distance =  $d_1+d_2+d_3+d_4$ , where:

$$d_1 = 1.47t_i \left( v - m + \frac{at_i}{2} \right)$$

$t_i$  = time of initial maneuver, s;  
 $a$  = average acceleration, mph/s;  
 $v$  = average speed of passing vehicle, mph;  
 $m$  = difference in speed of passed vehicle and passing vehicle, mph;

$$d_2 = 1.47vt_2$$

$t_2$  = time passing vehicle occupies left lanes, s;  
 $v$  = average speed of passing vehicle, mph.

$d_3 = 100 \text{ ft to } 300 \text{ ft}$ 
 $d_3$  = the distance between opposing vehicles at the end of passing maneuvers, ft;

$$d_4 = \frac{2d_2}{3}$$

$d_4$  = distance traveled by an opposing vehicle, ft.

## 202 - Superelevation

### 202.1 - General

In order to provide a safe, comfortable horizontal alignment for a highway, it is necessary to establish relationships between design speed and curvature and their joint relationship with superelevation and side friction. As any object travels in a circle, centrifugal force tends to move the object outward. For vehicles traveling on highway curves, centrifugal force is resisted by a combination of superelevation and friction between pavement and tires (side friction).

From the laws of mechanics, an approximate relationship for the four variables can be written:

$$f = \frac{V^2}{15R} - e$$

AASHTO EQ 3-9

where:

- $R$  = radius of curve, ft;
- $V$  = design speed, mph;
- $e$  = rate of roadway superelevation, ft/ft;
- $f$  = side friction factor.

Based on studies, including some performed in Arizona, maximum side friction is generally accepted as varying directly with speed, see Table 202.1B. Given a value for side friction, rates of superelevation can be calculated for combinations of speeds and curve radii. Thus, for any given radius and speed, there are an infinite number of superelevation and side friction combinations. ADOT, like most highway agencies, has established maximum rates of superelevation which are permitted for different locations and environmental conditions.

In determining a maximum allowable rate of superelevation, several factors must be taken into consideration including the potential for icy road conditions, the possibility of vehicle speeds significantly less than the design speed, driver comfort, and right-of-way constraints. With icy and wet roadway conditions, poor visibility and heavy traffic, drivers are constrained to drive at speeds considerably less than the design speed. Superelevation rates should not be so steep as to introduce driver discomfort or across-road sliding at reduced speeds.

ADOT's maximum rates of superelevation are shown in Table 202.1A.

**Table 202.1A**

**Relation of Highway Types to Maximum Superelevation**

| Highway Types                        | Maximum Superelevation ft/ft |
|--------------------------------------|------------------------------|
| <b>Rural Highways</b>                |                              |
| Controlled and non-controlled access |                              |
| Elevation < 4000 ft                  | 0.100                        |
| 4000 ft - 6000 ft                    | 0.080                        |
| Elevation > 6000 ft                  | 0.060                        |
| <b>Urban Highways</b>                |                              |
| Controlled access                    | 0.060                        |
| Non-controlled access                | 0.040                        |

**Table 202.1B**

**Relation of Design Speed to Maximum Side Friction, *f***

| Design Speed (mph) | Limiting Values of <i>f</i> |
|--------------------|-----------------------------|
| 30                 | 0.20                        |
| 35                 | 0.18                        |
| 40                 | 0.16                        |
| 45                 | 0.15                        |
| 50                 | 0.14                        |
| 55                 | 0.13                        |
| 60                 | 0.12                        |
| 65                 | 0.11                        |
| 70                 | 0.10                        |
| 75                 | 0.09                        |

Note: For ramps refer to [Chapter 500](#)

The relationships between design speed and curvature for various rates of superelevation are shown in [Tables 202.1A-B](#). AASHTO Method 5 was used to distribute  $e$  and  $f$  in calculating the appropriate radius in the tables.

**In certain situations and locations where design constraints justify the use of superelevation rates lower than those shown in the tables for a particular combination of speed and curvature, side friction demand shall be checked by the formula ([AASHTO Equation 3-9](#)).**

For low speeds  $\leq 45$  mph to better meet local conditions (e.g. urban section with curb and gutter), AASHTO Method 2 (AASHTO Exhibit 3-16) may be used to distribute  $e$  and  $f$ .

Superelevated cross slopes on curves extend the full width of the shoulders, except that the shoulder slope on the low side should not be flatter than the minimum shoulder slope used on the tangents. (Also see [Section 202.3 D](#) for shoulders in transition areas.)

Wherever possible, superelevation transitions should not be made on bridges.

## 202.2 - Axis of Rotation

Changes in cross slope should be effected by rotating pavement or lane edges about a fixed profile. The location of this axis of rotation for superelevation transitions has important impacts upon the length of superelevation transitions, drainage, driver perception, grade distortion, and aesthetics. **The superelevation axis of rotation shall coincide with the horizontal alignment control line and the profile grade line.** All of these factors enter into any consideration of deviating from the general concepts given below and illustrated in [Figure 202.2](#).

With rare exceptions, the location of the axis of rotation should remain constant throughout a project. If the location is shifted within a project for good reason, the shift must be carefully noted and detailed in the construction plans.

### A) *Controlled-access highways:*

- ♦ *Rural controlled-access highways* should be dual roadways of two lanes each and with full median separation. The superelevation axis of rotation should be at the centerline of each roadway or at the inside edge of the center lane if there are an odd number of lanes per roadway. ([Figure 202.2, View A](#))
- ♦ *Urban and urban-fringe controlled access highways* are generally planned for divided roadways of three or more lanes in each direction. Regardless of the number of lanes in the initial construction, the axis of rotation should be at the centerline of each four-lane ultimate roadway. ([Figure 202.2, View B](#))

If locating the axis of rotation as above will result in unsightly "saw-toothing" of bridges with covered medians, the axis of rotation may be moved to the median edge of roadway.

---

B) *Non-Controlled Access Highways:*

- ◆ *Rural divided non-controlled access highways* with medians of 50 ft or more between traveled ways should have the axis of rotation located at the centerline of each roadway or at the inside edge of the center lane if there are an odd number of lanes per roadway. (Figure 202.2, View C)

If the median width is less than 30 ft, the axis of rotation should be at the median edges of the traveled ways. (Figure 202.2, View D)

Between 30 ft and the desirable 50 ft minimum median, consideration should be given to locating the axis of rotation at the median edges of the traveled ways for highly superelevated curves to provide adequate median drainage. (Figure 202.2, View E)

For the 30 to 50 ft range of medians, the decision to locate the axis of rotation at other than the centerline of each roadway should be based upon a careful evaluation of median drainage requirements, clearance to overhead structures, additional earthwork and right-of-way requirements.

- ◆ *Rural undivided non-controlled access highways* should have the axis of rotation located at the centerline of the roadway. (Figure 202.2, View F)
- ◆ *Urban undivided non-controlled access highways* should have the axis of rotation located at the centerline of the highway. In those unusual cases where there is a raised median, the axes of rotation may be located at the inside edge of the traveled ways. (Figure 202.2, View G)

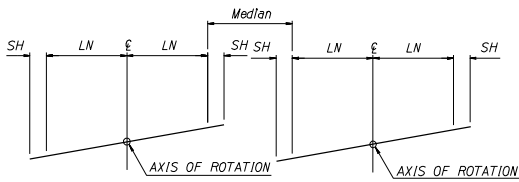

**(A) RURAL CONTROLLED ACCESS HIGHWAY**  
12° ROTATED

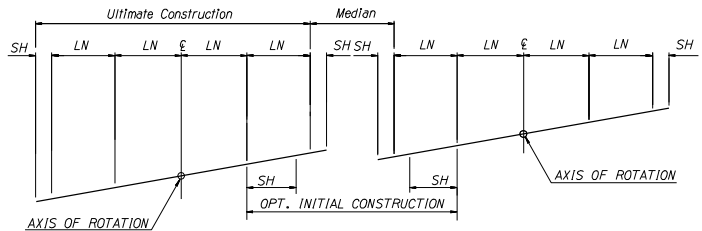

**(B) URBAN CONTROLLED ACCESS HIGHWAY**  
24° ROTATED

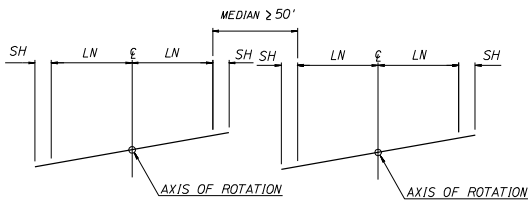

**(C) RURAL DIVIDED NON-CONTROLLED ACCESS HIGHWAY**  
Median 50 feet or greater  
12° ROTATED

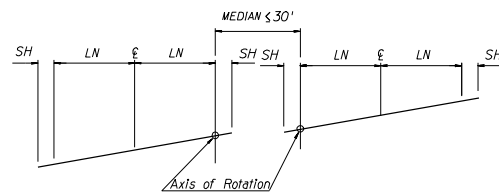

**(D) RURAL DIVIDED NON-CONTROLLED ACCESS HIGHWAY**  
Median 30 feet or less  
24° ROTATED

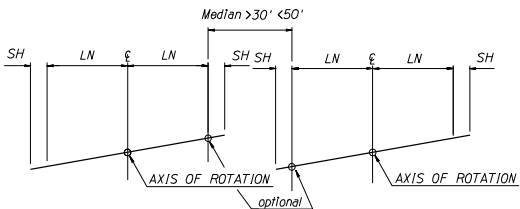

**(E) RURAL DIVIDED NON-CONTROLLED ACCESS HIGHWAY**  
Median greater than 30 feet, less than 50 feet  
12° ROTATED  
(24° OPTIONAL AXIS OF ROTATION)

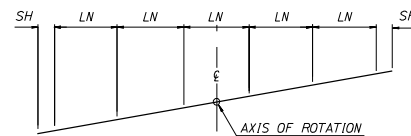

**(G) URBAN NON-DIVIDED NON-CONTROLLED ACCESS HIGHWAY**  
(Urban arterial)  
5 Lane section shown  
30° ROTATED

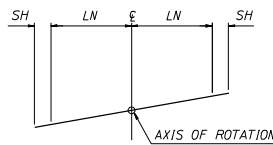

**(F) RURAL NON-DIVIDED NON-CONTROLLED ACCESS HIGHWAY**  
12° ROTATED

**NOTE**

LN = Lane  
SH = Shoulder varies

**LOCATION OF SUPERELEVATION AXIS OF ROTATION**  
**FIGURE 202.2**

### 202.3 - Superelevation Transition

- A) *General:* Superelevation transitions should be designed to provide safe, comfortable and aesthetically pleasing changes in rates of superelevation. The transition generally consists of a crown runoff length ( $L_c$ ) plus a superelevation runoff length ( $L_s$ ). The length of superelevation runoff is a function of the superelevation rate, design speed, maximum relative gradient, length of spiral and the distance ( $D$ ) from the axis of rotation to the edge of traveled way. The crown runoff length is a function of adverse cross slope to be removed and superelevation runoff length.
- B) *Runoff:* Tables 202.3A-D give the values of superelevation runoff lengths for various rates of superelevation and design speeds. The superelevation runoffs should be applied in the manner shown in Figures 202.3A-C. The crown runoff length is determined as a straight-line extension of the superelevation runoff.

Where spirals are used to transition the horizontal alignment from tangent to curve, the length of spiral should equal and coincide with the length of superelevation runoff as given in Tables 202.3A-D. Where spirals are not used, the transition length given in the tables should be distributed between the horizontal curve and the tangent as shown in Figure 202.3A. In both situations, the crown runoff should be on the tangent beyond the superelevation runoff.

The values given in Tables 202.3A-D are for roadways with one to three lanes from the axis of rotation to the outer edge of traveled way. These values cover the general situations represented by the cross-sections shown in Figure 202.2.

The values in Tables 202.3A-D were developed and are based upon the following criteria:

**Circular Curves** – the Relative Gradient Formula and Multiple Lane Factors.

**Spiral Curves** – the greater length from either the Relative Gradient Formula or the Desirable Length of Spiral Formula (both with Multiple Lane Factor applied) is compared against the length from the Maximum Length of Spiral Formula (with Multiple Lane Factor applied) with the lesser length being the controlling length.

As a final factor to control the abruptness of edge-of-pavement profile, AASHTO recommends limiting the maximum relative gradient for multi-lane applications to 50 percent greater than that of a single lane. These values are reflected in the superelevation tables.

- ♦ *Relative Gradient:* The length of superelevation runoff is based on a maximum acceptable difference, referred to as the relative gradient, between the longitudinal grades of the axis of rotation and edge of pavement. Experience indicates that maximum relative gradients for a two-lane roadway vary from 0.78 (equivalent relative slope of 1:128) at 15 mph to 0.35 (equivalent relative slope 1:286) at 80 mph. Interpolation between these two values provides the maximum relative gradients shown in AASHTO Exhibit 3-30.

$$L_r = \frac{(wn_1)e_d}{\Delta}(b_w)$$

AASHTO EQ 3-25

where:

 $L_r$  = minimum length of superelevation runoff, ft; $\Delta$  = maximum relative gradient, percent;\*  $n_1$  = number of lanes rotated;\*  $b_w$  = adjustment factor for number of lanes rotated; $w$  = width of one traffic lane, ft; $e_d$  = design superelevation rate, percent.

\* See Multiple Lanes criteria below.

- ◆ *Desirable Length of Spiral:* The desirable length of spiral is based upon the distance travelled in 2.0 seconds at a given design speed as expressed in the following equation:

$$L = 2.93V$$

See AASHTO EX 3-37

where:

 $L$  = desirable length of spiral, ft; $V$  = design speed, mph;

- ◆ *Maximum Length of Spiral:* Experience has shown that there is a need to limit the length of spiral transition curves at the highest degrees of curvature. ADOT limits the maximum length of spiral transition to the value given by the equation below when this value is less than the length necessary to satisfy the maximum relative gradient criteria or the minimum length of spiral transition curve, whichever would otherwise govern. See [Section 203.3](#). Values, where applicable, in [Tables 202.3A-D](#) reflect this modification in the columns labeled for 12, 18, 24, 30 and 36 ft of rotated pavement width.

$$L_{s,\max} = \sqrt{24(\rho_{\max})R}$$

AASHTO EQ 3-30

where:

 $L_{s,\max}$  = maximum length of spiral, ft; $\rho_{\max}$  = maximum lateral offset, 3.3 ft; $R$  = radius of circular curve, ft.

- ◆ *Multiple Lanes:* The minimum lengths for superelevation transitions determined by the above recommendations are for transitioning one 12 ft lane. Where superelevation is transitioned across multiple lanes, the transition length, as determined above, should be multiplied by 1.25 for 1.5 lane widths; by 1.5, 1.75 or 2.0 for 2, 2.5 or 3 lane widths, respectively. These factors are illustrated in AASHTO Exhibit 3-31.

Values in [Tables 202.3A-D](#) reflect this modification in the columns labeled for 12, 18, 24, 30 and 36 ft of rotated pavement width. For values of  $n_1$  greater than 3.0 (36 ft), use the following equation:

$$b_w = (1 + 0.5(n_1 - 1)) / n_1$$

NCHRP Report 439 Table 23

where:

$n_1$  = number of lanes rotated;

$b_w$  = adjustment factor for number of lanes rotated.

- C) *Restrictive situations:* In those situations where the standard superelevation rate is not practical or a given transition length is not attainable, the highest possible rate and the longest transition length should be used. However, the change in superelevation rate should not exceed 0.06 ft/ft per 100 ft of alignment for a 12 ft lane. Use of shorter transition lengths than those given in [Tables 202.3A-D](#) should be documented in the project files.

Situations may occur on mountainous two-lane highways, interchange ramps, separate turning lanes, etc., where the combination of short radii, short curves and short tangents preclude achieving the desired superelevation rates and transitions. These situations may also occur on highways or ramps with reversed curves connected with short tangents. Every effort should be made to avoid situations where less than desirable rates of superelevation or superelevation transition lengths are used.

- D) *Shoulders:* Roadway shoulders rotate about the adjacent lane edge. In a normal section shoulders have the same cross-slope as the adjacent lane. In such cases, when transitioning to and from a superelevated section, the shoulder will rotate in the same plane as the adjacent lane. The length of transition will be as required for the adjacent lane.

Occasionally, the shoulder cross-slope is opposite or greater than the adjacent lane cross-slope. When on the outside of the curve, the shoulder should transition to the plane of the adjacent lane during the length of normal crown removal ([B – C on Figure 202.3B](#)). When on the inside of the curve, the shoulder should retain its normal cross-slope until the adjacent lane superelevation matches it. Then the shoulder and adjacent lane will rotate in the same plane.

- E) *Edge profiles:* For roadways transitioning more than two lanes and for curbed roadways, after the superelevation transition is designed, outer edge profiles of the traveled way and shoulders should be plotted and irregularities replaced by smooth curves. For a guide, the design speed in miles per hour can be used as the minimum vertical curve length in ft. Greater lengths should be used where practical. Flat areas are undesirable for drainage and should be avoided.

- F) *Ramp and lane tapers*: Ramp lanes and ramp tapers normally rotate at the same rate as the adjacent mainline. An exception to his general statement is the case of parallel exit and entrance ramps, explained in [Chapter 500](#).

#### **202.4 - Superelevation Diagrams**

Superelevation diagrams schematically show the rotation of the outside edge of travel lane and the inside edge of travel lane, in relation to the roadway axis of rotation. Superelevation diagrams are developed by the designer and are to be shown with the profile sheets of all plans for new construction having horizontal curvature. In the past superelevation distribution was included in the Standard Drawings and were referred to by designers and utilized by field construction personnel to construct the roadway. Superelevation diagrams are now required due to increased complexity in design and the importance of thoroughly describing pavement rotation to achieve the desired results for traffic operations, drainage and driver comfort. Information on Figures 202.3A-C is to be utilized by the designers in developing their superelevation diagrams.

When a shoulder has a different cross slope than the roadway cross slope, shoulder transitions are also shown on the superelevation diagram.

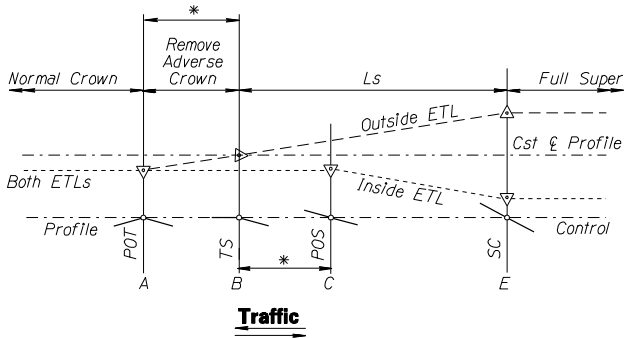

**Spiral Curve Transition**

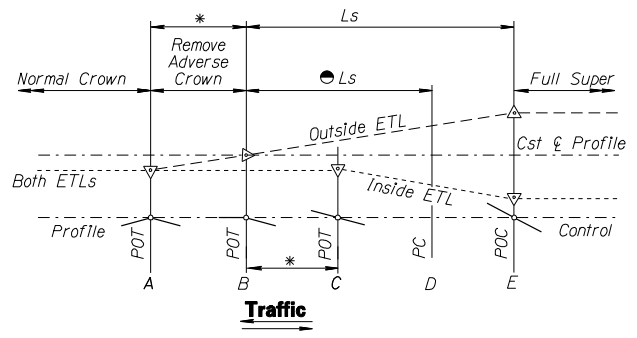

**Circular Curve Transition**

2-WAY ROADWAY  
 AXIS OF ROTATION AT ROADWAY &  
 RIGHT TURNING ROADWAY

Values of  $\phi$  for Circular Curves

| Design speed (mph) | Portion of runoff located prior to the curve |              |              |              |              |
|--------------------|--|--------------|--------------|--------------|--------------|
|                    | No. of lanes rotated (D)                     |              |              |              |              |
|                    | 1.0<br>(12')                                 | 1.5<br>(18') | 2.0<br>(24') | 2.5<br>(30') | 3.0<br>(36') |
| 15-45              | 0.80   | 0.85         | 0.90         | 0.90         | 0.90         |
| 50-75              | 0.70   | 0.75         | 0.80         | 0.80         | 0.85         |

D = Distance from axis of rotation to outer edge of traveled lane, ft  
 Refer to AASHTO Exhibit 3-33

**GENERAL NOTES**

Round edge profile intersections with vertical curves having length in feet equal to the design speed in mph.

For main roadway curves without spirals,  $\phi L_s$  is on tangent and the remainder is on curve.

Shoulders transition with the adjacent travel lane when their normal cross slopes are the same.

See Figure 202.3C for method of rotating median shoulders with adverse cross slope.

**LEGEND**

- A Point at which adverse crown removal begins
- B Point at which super-elevation runoff begins
- C Point of equality between super-elevation and normal crown
- D PC location for circular curve transition
- E Point at which full super-elevation is reached

- ETL Edge of travel lane
- Ls Superelevation runoff length
- \* Distance = (NC/e)Ls
- $\phi$  Factor for location of super-elevation runoff on circular curves (See Table, above)

**SUPERELEVATION TRANSITION DISTRIBUTION  
 FIGURE 202.3A**

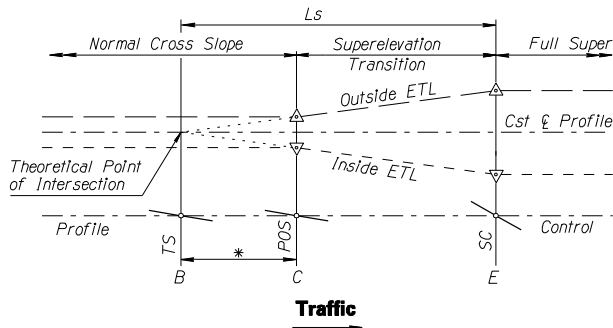

**Spiral Curve Transition**

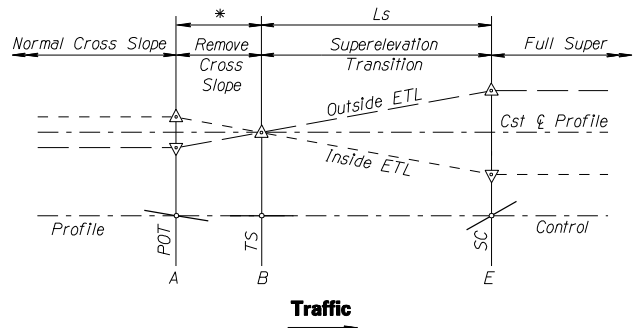

**Spiral Curve Transition**

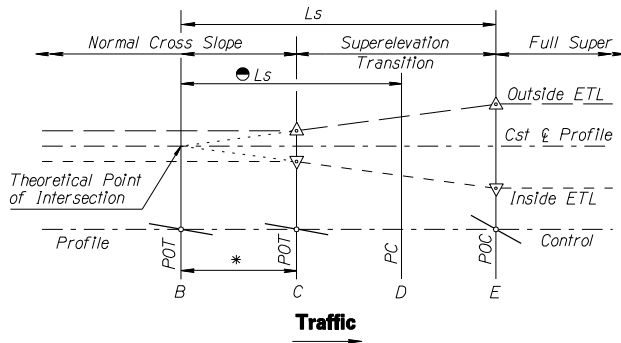

**Circular Curve Transition**

1-WAY ROADWAY  
 AXIS OF ROTATION AT ROADWAY &  
 SUPERELEVATION IN DIRECTION OF NORMAL CROSS SLOPE  
 RIGHT TURNING ROADWAY

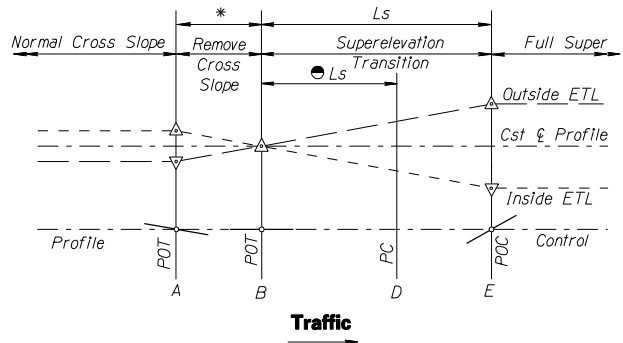

**Circular Curve Transition**

1-WAY ROADWAY  
 AXIS OF ROTATION AT ROADWAY &  
 SUPERELEVATION OPPOSITE DIRECTION OF NORMAL CROSS SLOPE  
 LEFT TURNING ROADWAY

**LEGEND**

- A Point at which adverse cross slope removal begins
- B Point at which superelevation runoff begins
- C Point of equality between superelevation and normal crown
- D PC location for circular curve transition
- E Point at which full superelevation is reached

- ETL Edge of travel lane
- Ls Superelevation runoff length
- \* Distance =  $(NC/e)Ls$
- Factor for location of superelevation runoff on circular curves (See Table in Fig. 202.3A)

**SUPERELEVATION TRANSITION DISTRIBUTION  
 FIGURE 202.3B**

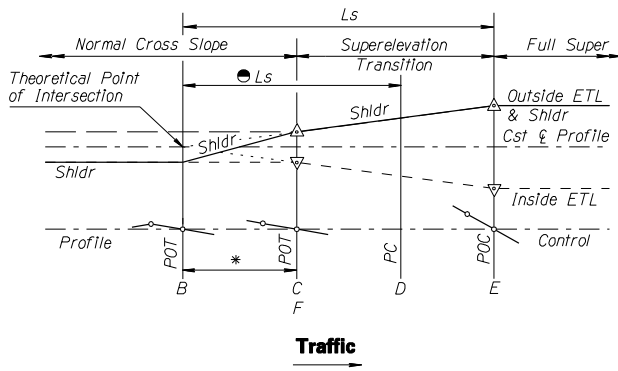

**Median Shoulder Transition  
Circular Curve**

*1-WAY ROADWAY  
AXIS OF ROTATION AT ROADWAY &  
SUPERELEVATION IN DIRECTION OF NORMAL CROSS SLOPE  
RIGHT TURNING ROADWAY  
SHOULDER AXIS OF ROTATION AT ADJACENT ETL*

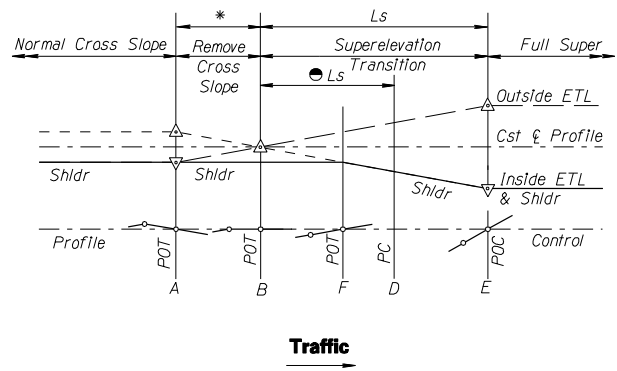

**Median Shoulder Transition  
Circular Curve**

*1-WAY ROADWAY  
AXIS OF ROTATION AT ROADWAY &  
SUPERELEVATION OPPOSITE DIRECTION OF NORMAL CROSS SLOPE  
LEFT TURNING ROADWAY  
SHOULDER AXIS OF ROTATION AT ADJACENT ETL*

**LEGEND**

- A Point at which adverse cross slope removal begins
- B Point at which superelevation runoff begins
- C Point of equality between superelevation and normal crown
- D PC location for circular curve transition
- E Point at which full superelevation is reached
- F Point where slope of mainline equals slope of shoulder

- ETL Edge of travel lane
- Ls Superelevation runoff length
- \* Distance =  $(NC/e)Ls$
- Factor for location of superelevation runoff on circular curves (See Table in Fig. 202.3A)

**SUPERELEVATION TRANSITION DISTRIBUTION  
FIGURE 202.3C**

**TABLE 202.3A**  
**Superelevation Rates and Transition Lengths for  $e_{max} = 0.040$  ft/ft**

| V=30 MPH |      |                    |    |     |     |     | V=40 MPH |      |                    |     |     |     |     | V=45 MPH |      |                    |     |     |     |     | V=50 MPH |      |                    |     |     |     |     |
|----------|------|--------------------|----|-----|-----|-----|----------|------|--------------------|-----|-----|-----|-----|----------|------|--------------------|-----|-----|-----|-----|----------|------|--------------------|-----|-----|-----|-----|
|          |      | Ls for Values of D |    |     |     |     |          |      | Ls for Values of D |     |     |     |     |          |      | Ls for Values of D |     |     |     |     |          |      | Ls for Values of D |     |     |     |     |
| Dc       | e    | 12                 | 18 | 24  | 30  | 36  | Dc       | e    | 12                 | 18  | 24  | 30  | 36  | Dc       | e    | 12                 | 18  | 24  | 30  | 36  | Dc       | e    | 12                 | 18  | 24  | 30  | 36  |
| 2°13'    | .020 | 36                 | 45 | 55  | 64  | 73  | 1°21'    | .020 | 41                 | 52  | 62  | 72  | 83  | 1°06'    | .020 | 44                 | 55  | 67  | 78  | 89  | 0°55'    | .020 | 48                 | 60  | 72  | 84  | 96  |
| 3°00'    | .020 | 36                 | 45 | 55  | 64  | 73  | 1°45'    | .020 | 41                 | 52  | 62  | 72  | 83  | 1°15'    | .020 | 44                 | 55  | 67  | 78  | 89  | 1°00'    | .020 | 48                 | 60  | 72  | 84  | 96  |
| 3°15'    | .021 | 38                 | 48 | 57  | 67  | 77  | 2°00'    | .022 | 46                 | 57  | 68  | 80  | 91  | 1°30'    | .021 | 47                 | 58  | 70  | 82  | 94  | 1°15'    | .021 | 50                 | 63  | 76  | 88  | 101 |
| 3°30'    | .022 | 40                 | 50 | 60  | 70  | 80  | 2°15'    | .023 | 48                 | 59  | 71  | 83  | 96  | 1°45'    | .023 | 51                 | 64  | 77  | 89  | 103 | 1°30'    | .024 | 58                 | 72  | 86  | 101 | 116 |
| 4°00'    | .023 | 42                 | 52 | 63  | 73  | 84  | 2°30'    | .024 | 50                 | 62  | 74  | 87  | 100 | 2°00'    | .025 | 56                 | 69  | 83  | 97  | 112 | 1°45'    | .026 | 62                 | 78  | 94  | 109 | 125 |
| 4°30'    | .024 | 44                 | 54 | 65  | 76  | 88  | 2°45'    | .025 | 52                 | 64  | 78  | 91  | 104 | 2°15'    | .026 | 58                 | 72  | 87  | 101 | 116 | 2°00'    | .027 | 65                 | 81  | 97  | 113 | 130 |
| 5°00'    | .025 | 45                 | 57 | 68  | 80  | 91  | 3°00'    | .026 | 54                 | 67  | 81  | 94  | 108 | 2°30'    | .027 | 60                 | 75  | 90  | 105 | 121 | 2°15'    | .029 | 70                 | 87  | 104 | 122 | 140 |
| 5°30'    | .026 | 47                 | 59 | 71  | 83  | 95  | 3°15'    | .027 | 56                 | 70  | 84  | 98  | 112 | 2°45'    | .028 | 62                 | 77  | 93  | 109 | 125 | 2°30'    | .030 | 72                 | 90  | 108 | 126 | 145 |
| 6°00'    | .027 | 49                 | 61 | 74  | 86  | 99  | 3°30'    | .028 | 58                 | 72  | 87  | 101 | 116 | 3°00'    | .029 | 64                 | 80  | 97  | 113 | 130 | 2°45'    | .031 | 74                 | 93  | 112 | 130 | 150 |
| 7°00'    | .028 | 51                 | 63 | 76  | 89  | 102 | 3°45'    | .029 | 60                 | 75  | 90  | 105 | 121 | 3°15'    | .030 | 67                 | 83  | 100 | 117 | 134 | 3°00'    | .033 | 79                 | 99  | 119 | 139 | 159 |
| 8°00'    | .030 | 55                 | 68 | 82  | 95  | 110 | 4°00'    | .030 | 62                 | 77  | 93  | 109 | 125 | 3°30'    | .031 | 69                 | 86  | 103 | 121 | 138 | 3°15'    | .034 | 82                 | 102 | 122 | 143 | 164 |
| 9°00'    | .031 | 56                 | 70 | 85  | 99  | 113 | 4°30'    | .031 | 64                 | 80  | 96  | 112 | 129 | 3°45'    | .032 | 71                 | 89  | 107 | 124 | 143 | 3°30'    | .035 | 84                 | 105 | 126 | 147 | 169 |
| 10°00'   | .032 | 58                 | 72 | 87  | 102 | 117 | 5°00'    | .032 | 66                 | 82  | 99  | 116 | 133 | 4°00'    | .033 | 73                 | 91  | 110 | 128 | 147 | 4°00'    | .036 | 86                 | 108 | 130 | 151 | 174 |
| 11°00'   | .033 | 60                 | 75 | 90  | 105 | 121 | 5°30'    | .034 | 70                 | 88  | 106 | 123 | 141 | 4°30'    | .035 | 78                 | 97  | 117 | 136 | 156 | 4°30'    | .038 | 91                 | 114 | 137 | 160 | 183 |
| 12°00'   | .034 | 62                 | 77 | 93  | 108 | 124 | 6°00'    | .035 | 72                 | 90  | 109 | 127 | 146 | 5°00'    | .036 | 80                 | 100 | 120 | 140 | 161 | 5°00'    | .039 | 94                 | 117 | 140 | 164 | 188 |
| 13°00'   | .035 | 64                 | 79 | 95  | 111 | 128 | 6°30'    | .036 | 74                 | 93  | 112 | 130 | 150 | 5°30'    | .037 | 82                 | 102 | 123 | 144 | 165 | 5°30'    | .040 | 96                 | 120 | 144 | 168 | 193 |
| 14°00'   | .036 | 65                 | 81 | 98  | 115 | 132 | 7°00'    | .037 | 77                 | 95  | 115 | 134 | 154 | 6°00'    | .038 | 84                 | 105 | 127 | 148 | 170 | 6°11'    | .040 | 96                 | 120 | 144 | 168 | 193 |
| 15°00'   | .037 | 67                 | 84 | 101 | 118 | 135 | 8°00'    | .038 | 79                 | 98  | 118 | 138 | 158 | 6°30'    | .039 | 87                 | 108 | 130 | 152 | 174 |          |      |                    |     |     |     |     |
| 16°00'   | .038 | 69                 | 86 | 104 | 121 | 139 | 9°00'    | .039 | 81                 | 100 | 121 | 141 | 162 | 7°00'    | .040 | 89                 | 111 | 133 | 156 | 179 |          |      |                    |     |     |     |     |
| 18°00'   | .039 | 71                 | 88 | 106 | 124 | 143 | 10°00'   | .040 | 83                 | 103 | 124 | 145 | 166 | 8°04'    | .040 | 89                 | 111 | 133 | 156 | 179 |          |      |                    |     |     |     |     |
| 20°00'   | .040 | 73                 | 91 | 109 | 127 | 146 | 10°45'   | .040 | 83                 | 103 | 124 | 145 | 166 |          |      |                    |     |     |     |     |          |      |                    |     |     |     |     |
| 22°55'   | .040 | 73                 | 91 | 109 | 127 | 146 |          |      |                    |     |     |     |     |          |      |                    |     |     |     |     |          |      |                    |     |     |     |     |

| V=55 MPH |      |                    |     |     |     |     | V=60 MPH |      |                    |     |     |     |     |
|----------|------|--------------------|-----|-----|-----|-----|----------|------|--------------------|-----|-----|-----|-----|
|          |      | Ls for Values of D |     |     |     |     |          |      | Ls for Values of D |     |     |     |     |
| Dc       | e    | 12                 | 18  | 24  | 30  | 36  | Dc       | e    | 12                 | 18  | 24  | 30  | 36  |
| 0°46'    | .020 | 51                 | 64  | 77  | 89  | 103 | 0°40'    | .020 | 53                 | 66  | 80  | 93  | 107 |
| 1°00'    | .021 | 54                 | 67  | 80  | 94  | 108 | 0°45'    | .020 | 53                 | 66  | 80  | 93  | 107 |
| 1°15'    | .024 | 61                 | 76  | 92  | 107 | 123 | 1°00'    | .023 | 61                 | 76  | 92  | 107 | 123 |
| 1°30'    | .026 | 66                 | 83  | 100 | 116 | 133 | 1°15'    | .026 | 69                 | 86  | 104 | 121 | 139 |
| 1°45'    | .028 | 71                 | 89  | 107 | 125 | 144 | 1°30'    | .029 | 77                 | 96  | 116 | 135 | 155 |
| 2°00'    | .030 | 77                 | 95  | 115 | 134 | 154 | 1°45'    | .031 | 83                 | 103 | 124 | 145 | 166 |
| 2°15'    | .032 | 82                 | 102 | 123 | 143 | 164 | 2°00'    | .033 | 88                 | 110 | 132 | 154 | 177 |
| 2°30'    | .033 | 84                 | 105 | 126 | 147 | 169 | 2°15'    | .035 | 93                 | 116 | 140 | 163 | 188 |
| 2°45'    | .035 | 89                 | 111 | 134 | 156 | 180 | 2°30'    | .036 | 96                 | 120 | 144 | 168 | 193 |
| 3°00'    | .036 | 92                 | 114 | 138 | 161 | 185 | 2°45'    | .038 | 101                | 126 | 152 | 177 | 204 |
| 3°15'    | .037 | 94                 | 118 | 142 | 165 | 190 | 3°00'    | .039 | 104                | 129 | 156 | 182 | 209 |
| 3°30'    | .038 | 97                 | 121 | 146 | 170 | 195 | 3°15'    | .039 | 104                | 129 | 156 | 182 | 209 |
| 3°45'    | .039 | 100                | 124 | 149 | 174 | 200 | 3°30'    | .040 | 107                | 133 | 160 | 187 | 214 |
| 4°00'    | .039 | 100                | 124 | 149 | 174 | 200 | 3°49'    | .040 | 107                | 133 | 160 | 187 | 214 |
| 4°15'    | .040 | 102                | 127 | 153 | 179 | 205 |          |      |                    |     |     |     |     |
| 4°49'    | .040 | 102                | 127 | 153 | 179 | 205 |          |      |                    |     |     |     |     |

**LEGEND**

Dc = Degree of Curvature  
 D = Distance from axis of rotation to  
 outer edge of far travel lane, ft  
 e = Superelevation in ft/ft  
 Ls = Superelevation runoff, ft

**NOTES FOR 0.040 ft/ft SUPERELEVATION**

Use for urban arterial highways only. Spirals are not required.  
 Applicable for all elevations and climate conditions.  
 DO NOT use for ramps.  
 The first entry shows minimum Dc requiring a superelevated section; for  
 flatter curves, use normal tangent section with up to 2% adverse slope.  
 The last entry shows maximum Dc.

**TABLE 202.3B**  
**Superelevation Rates and Transition Lengths for  $e_{max} = 0.060$  ft/ft**

| V=30 MPH |      |                    |     |     |     | V=40 MPH |        |      |                    |     |     | V=45 MPH |     |       |      |                    |     | V=50 MPH |     |     |       |      |                    |     |     |     |     |
|----------|------|--------------------|-----|-----|-----|----------|--------|------|--------------------|-----|-----|----------|-----|-------|------|--------------------|-----|----------|-----|-----|-------|------|--------------------|-----|-----|-----|-----|
|          |      | Ls for Values of D |     |     |     |          |        |      | Ls for Values of D |     |     |          |     |       |      | Ls for Values of D |     |          |     |     |       |      | Ls for Values of D |     |     |     |     |
| Dc       | e    | 12                 | 18  | 24  | 30  | 36       | Dc     | e    | 12                 | 18  | 24  | 30       | 36  | Dc    | e    | 12                 | 18  | 24       | 30  | 36  | Dc    | e    | 12                 | 18  | 24  | 30  | 36  |
| 2°13'    | .020 | 36                 | 45  | 55  | 64  | 73       | 1°21'  | .020 | 41                 | 52  | 62  | 72       | 83  | 1°06' | .020 | 44                 | 55  | 67       | 78  | 89  | 0°55' | .020 | 48                 | 60  | 72  | 84  | 96  |
| 2°30'    | .020 | 36                 | 45  | 55  | 64  | 73       | 1°30'  | .020 | 41                 | 52  | 62  | 72       | 83  | 1°15' | .020 | 44                 | 55  | 67       | 78  | 89  | 1°00' | .020 | 48                 | 60  | 72  | 84  | 96  |
| 2°45'    | .021 | 38                 | 48  | 57  | 67  | 77       | 1°45'  | .023 | 48                 | 59  | 71  | 83       | 96  | 1°30' | .024 | 53                 | 66  | 80       | 93  | 107 | 1°15' | .024 | 58                 | 72  | 86  | 101 | 116 |
| 3°00'    | .023 | 42                 | 52  | 63  | 73  | 84       | 2°00'  | .025 | 52                 | 64  | 78  | 91       | 104 | 1°45' | .027 | 60                 | 75  | 90       | 105 | 121 | 1°30' | .028 | 67                 | 84  | 101 | 118 | 135 |
| 3°15'    | .024 | 44                 | 54  | 65  | 76  | 88       | 2°15'  | .028 | 58                 | 72  | 87  | 101      | 116 | 2°00' | .030 | 67                 | 83  | 100      | 117 | 134 | 1°45' | .031 | 74                 | 93  | 112 | 130 | 150 |
| 3°30'    | .026 | 47                 | 59  | 71  | 83  | 95       | 2°30'  | .030 | 62                 | 77  | 93  | 109      | 125 | 2°15' | .033 | 73                 | 91  | 110      | 128 | 147 | 2°00' | .035 | 84                 | 105 | 126 | 147 | 169 |
| 3°45'    | .027 | 49                 | 61  | 74  | 86  | 99       | 2°45'  | .032 | 66                 | 82  | 99  | 116      | 133 | 2°30' | .035 | 78                 | 97  | 117      | 136 | 156 | 2°15' | .038 | 91                 | 114 | 137 | 160 | 183 |
| 4°00'    | .028 | 51                 | 63  | 76  | 89  | 102      | 3°00'  | .034 | 70                 | 88  | 106 | 123      | 141 | 2°45' | .037 | 82                 | 102 | 123      | 144 | 165 | 2°30' | .040 | 96                 | 120 | 144 | 168 | 193 |
| 4°15'    | .030 | 55                 | 68  | 82  | 95  | 110      | 3°15'  | .036 | 74                 | 93  | 112 | 130      | 150 | 3°00' | .039 | 87                 | 108 | 130      | 152 | 174 | 2°45' | .042 | 101                | 125 | 151 | 176 | 203 |
| 4°30'    | .031 | 56                 | 70  | 85  | 99  | 113      | 3°30'  | .037 | 77                 | 95  | 115 | 134      | 154 | 3°15' | .041 | 91                 | 113 | 137      | 159 | 183 | 3°00' | .044 | 106                | 131 | 158 | 185 | 212 |
| 5°00'    | .033 | 60                 | 75  | 90  | 105 | 121      | 3°45'  | .039 | 81                 | 100 | 121 | 141      | 162 | 3°30' | .043 | 96                 | 119 | 143      | 167 | 192 | 3°15' | .046 | 110                | 137 | 166 | 193 | 222 |
| 6°00'    | .036 | 65                 | 81  | 98  | 115 | 132      | 4°00'  | .040 | 83                 | 103 | 124 | 145      | 166 | 3°45' | .044 | 98                 | 122 | 147      | 171 | 197 | 3°30' | .048 | 115                | 143 | 173 | 202 | 232 |
| 7°00'    | .039 | 71                 | 88  | 106 | 124 | 143      | 4°30'  | .043 | 89                 | 111 | 133 | 156      | 179 | 4°00' | .046 | 102                | 127 | 153      | 179 | 205 | 3°45' | .050 | 120                | 149 | 180 | 210 | 241 |
| 8°00'    | .041 | 75                 | 93  | 112 | 130 | 150      | 5°00'  | .045 | 93                 | 116 | 140 | 163      | 187 | 4°30' | .048 | 107                | 133 | 160      | 187 | 214 | 4°00' | .051 | 122                | 152 | 184 | 214 | 246 |
| 9°00'    | .043 | 78                 | 97  | 117 | 137 | 157      | 5°30'  | .047 | 97                 | 121 | 146 | 170      | 195 | 5°00' | .051 | 113                | 141 | 170      | 198 | 228 | 4°15' | .053 | 127                | 158 | 191 | 223 | 256 |
| 10°00'   | .045 | 82                 | 102 | 123 | 143 | 164      | 6°00'  | .049 | 101                | 126 | 152 | 177      | 204 | 5°30' | .053 | 118                | 147 | 177      | 206 | 237 | 4°30' | .054 | 130                | 161 | 194 | 227 | 260 |
| 11°00'   | .047 | 85                 | 106 | 128 | 150 | 172      | 6°30'  | .051 | 106                | 131 | 158 | 185      | 212 | 6°00' | .055 | 132                | 165 | 198      | 231 | 264 | 5°00' | .056 | 147                | 184 | 221 | 257 | 294 |
| 12°00'   | .049 | 89                 | 111 | 134 | 156 | 179      | 7°00'  | .052 | 108                | 134 | 161 | 188      | 216 | 6°30' | .057 | 132                | 165 | 198      | 231 | 264 | 5°30' | .058 | 147                | 184 | 221 | 257 | 294 |
| 13°00'   | .051 | 93                 | 115 | 139 | 162 | 186      | 7°30'  | .054 | 117                | 146 | 176 | 205      | 234 | 7°00' | .058 | 132                | 165 | 198      | 231 | 264 | 6°00' | .059 | 147                | 184 | 221 | 257 | 294 |
| 14°00'   | .052 | 95                 | 118 | 142 | 165 | 190      | 8°00'  | .055 | 117                | 146 | 176 | 205      | 234 | 7°30' | .059 | 132                | 165 | 198      | 231 | 264 | 6°30' | .060 | 147                | 184 | 221 | 257 | 294 |
| 16°00'   | .055 | 100                | 125 | 150 | 175 | 201      | 9°00'  | .057 | 118                | 147 | 177 | 206      | 237 | 8°00' | .060 | 133                | 166 | 200      | 233 | 268 | 6°53' | .060 | 147                | 184 | 221 | 257 | 294 |
| 18°00'   | .057 | 104                | 129 | 155 | 181 | 208      | 10°00' | .059 | 122                | 152 | 183 | 214      | 245 | 8°55' | .060 | 133                | 166 | 200      | 233 | 268 |       |      |                    |     |     |     |     |
| 20°00'   | .058 | 105                | 131 | 158 | 185 | 212      | 11°00' | .060 | 124                | 155 | 186 | 217      | 250 |       |      |                    |     |          |     |     |       |      |                    |     |     |     |     |
| 22°00'   | .059 | 107                | 134 | 161 | 188 | 216      | 11°49' | .060 | 124                | 155 | 186 | 217      | 250 |       |      |                    |     |          |     |     |       |      |                    |     |     |     |     |
| 24°48'   | .060 | 109                | 136 | 164 | 191 | 219      |        |      |                    |     |     |          |     |       |      |                    |     |          |     |     |       |      |                    |     |     |     |     |

| V=55 MPH |      |                    |     |     |     | V=60 MPH |       |      |                    |     |     | V=65 MPH |     |       |      |                    |     | V=70 MPH |     |     |       |      |                    |     |     |     |     |
|----------|------|--------------------|-----|-----|-----|----------|-------|------|--------------------|-----|-----|----------|-----|-------|------|--------------------|-----|----------|-----|-----|-------|------|--------------------|-----|-----|-----|-----|
|          |      | Ls for Values of D |     |     |     |          |       |      | Ls for Values of D |     |     |          |     |       |      | Ls for Values of D |     |          |     |     |       |      | Ls for Values of D |     |     |     |     |
| Dc       | e    | 12                 | 18  | 24  | 30  | 36       | Dc    | e    | 12                 | 18  | 24  | 30       | 36  | Dc    | e    | 12                 | 18  | 24       | 30  | 36  | Dc    | e    | 12                 | 18  | 24  | 30  | 36  |
| 0°46'    | .020 | 51                 | 64  | 77  | 89  | 103      | 0°40' | .020 | 53                 | 66  | 80  | 93       | 107 | 0°36' | .020 | 56                 | 69  | 84       | 98  | 112 | 0°32' | .020 | 60                 | 75  | 90  | 105 | 121 |
| 1°00'    | .023 | 59                 | 73  | 88  | 103 | 118      | 1°00' | .027 | 72                 | 90  | 108 | 126      | 145 | 1°00' | .030 | 84                 | 104 | 126      | 147 | 168 | 0°45' | .026 | 78                 | 97  | 117 | 137 | 157 |
| 1°15'    | .028 | 71                 | 89  | 107 | 125 | 144      | 1°15' | .032 | 85                 | 106 | 128 | 149      | 172 | 1°15' | .036 | 100                | 125 | 151      | 176 | 202 | 1°00' | .033 | 99                 | 123 | 149 | 173 | 199 |
| 1°30'    | .032 | 82                 | 102 | 123 | 143 | 164      | 1°30' | .037 | 99                 | 123 | 148 | 173      | 198 | 1°30' | .041 | 114                | 142 | 172      | 200 | 230 | 1°15' | .040 | 120                | 149 | 180 | 210 | 241 |
| 1°45'    | .036 | 92                 | 114 | 138 | 161 | 185      | 1°45' | .041 | 109                | 136 | 164 | 191      | 220 | 1°45' | .046 | 128                | 160 | 193      | 225 | 258 | 1°30' | .046 | 138                | 172 | 207 | 242 | 277 |
| 2°00'    | .040 | 102                | 127 | 153 | 179 | 205      | 2°00' | .045 | 120                | 149 | 180 | 210      | 241 | 2°00' | .049 | 137                | 170 | 205      | 239 | 275 | 1°45' | .051 | 153                | 190 | 230 | 268 | 308 |
| 2°15'    | .043 | 110                | 137 | 165 | 192 | 221      | 2°15' | .048 | 128                | 159 | 192 | 224      | 257 | 2°15' | .053 | 148                | 184 | 222      | 259 | 297 | 2°00' | .055 | 165                | 205 | 248 | 289 | 332 |
| 2°30'    | .045 | 115                | 143 | 172 | 201 | 231      | 2°30' | .051 | 136                | 169 | 204 | 238      | 273 | 2°30' | .055 | 153                | 191 | 230      | 269 | 309 | 2°15' | .057 | 171                | 213 | 257 | 299 | 344 |
| 2°45'    | .048 | 123                | 153 | 184 | 214 | 246      | 2°45' | .053 | 141                | 176 | 212 | 247      | 284 | 2°45' | .058 | 191                | 239 | 287      | 334 | 382 | 2°30' | .059 | 205                | 256 | 308 | 359 | 410 |
| 3°00'    | .050 | 128                | 159 | 191 | 223 | 257      | 3°00' | .055 | 147                | 183 | 220 | 257      | 295 | 3°00' | .059 | 191                | 239 | 287      | 334 | 382 | 2°45' | .060 | 205                | 256 | 308 | 359 | 410 |
| 3°15'    | .052 | 133                | 165 | 199 | 232 | 267      | 3°15' | .057 | 176                | 220 | 264 | 308      | 352 | 3°15' | .060 | 191                | 239 | 287      | 334 | 382 | 2°49' | .060 | 205                | 256 | 308 | 359 | 410 |
| 3°30'    | .054 | 138                | 172 | 207 | 241 | 277      | 3°30' | .058 | 176                | 220 | 264 | 308      | 352 | 3°27' | .060 | 191                | 239 | 287      | 334 | 382 |       |      |                    |     |     |     |     |
| 3°45'    | .055 | 161                | 201 | 242 | 282 | 322      | 3°45' | .059 | 176                | 220 | 264 | 308      | 352 |       |      |                    |     |          |     |     |       |      |                    |     |     |     |     |
| 4°00'    | .057 | 161                | 201 | 242 | 282 | 322      | 4°00' | .060 | 176                | 220 | 264 | 308      | 352 |       |      |                    |     |          |     |     |       |      |                    |     |     |     |     |
| 4°15'    | .058 | 161                | 201 | 242 | 282 | 322      | 4°18' | .060 | 176                | 220 | 264 | 308      | 352 |       |      |                    |     |          |     |     |       |      |                    |     |     |     |     |
| 4°30'    | .059 | 161                | 201 | 242 | 282 | 322      |       |      |                    |     |     |          |     |       |      |                    |     |          |     |     |       |      |                    |     |     |     |     |
| 5°00'    | .060 | 161                | 201 | 242 | 282 | 322      |       |      |                    |     |     |          |     |       |      |                    |     |          |     |     |       |      |                    |     |     |     |     |
| 5°24'    | .060 | 161                | 201 | 242 | 282 | 322      |       |      |                    |     |     |          |     |       |      |                    |     |          |     |     |       |      |                    |     |     |     |     |

| V=75 MPH |      |                    |     |     |     |     |
|----------|------|--------------------|-----|-----|-----|-----|
|          |      | Ls for Values of D |     |     |     |     |
| Dc       | e    | 12                 | 18  | 24  | 30  | 36  |
| 0°29'    | .020 | 63                 | 79  | 95  | 111 | 127 |
| 0°30'    | .020 | 63                 | 79  | 95  | 111 | 127 |
| 0°45'    | .029 | 92                 | 114 | 137 | 160 | 184 |
| 1°00'    | .037 | 117                | 145 | 175 | 204 | 235 |
| 1°15'    | .044 | 139                | 173 | 208 | 243 | 279 |
| 1°30'    | .051 | 161                | 201 | 242 | 282 | 324 |
| 1°45'    | .056 | 177                | 220 | 265 | 309 | 355 |
| 2°00'    | .059 | 186                | 232 | 279 | 326 | 374 |
| 2°15'    | .060 | 220                | 275 | 330 | 385 | 440 |
| 2°18'    | .060 | 220                | 275 | 330 | 385 | 440 |

**LEGEND**

Dc = Degree of Curvature  
 D = Distance from axis of rotation to outer edge of far travel lane, ft  
 e = Superelevation in ft/ft  
 Ls = Superelevation runoff, ft

**NOTES FOR 0.060 ft/ft SUPERELEVATION**

Use for all rural highways at elevations over 6000 ft and for definite snow or ice conditions.  
 Use spirals below heavy line, circular curves above.  
 Use for urban controlled access highways including ramps. Spirals are optional on urban highways.  
 If using a circular curve below the heavy line, Ls may be calculated using the maximum relative gradient formula.  
 The first entry shows minimum Dc requiring a superelevated section; for flatter curves, use normal tangent section with up to 2% adverse slope.  
 The last entry shows maximum Dc.

**TABLE 202.3C  
Superelevation Rates and Transition Lengths for  $e_{max} = 0.080$  ft/ft**

| V=30 MPH           |      |     |     |     |     | V=40 MPH           |        |      |     |     |     | V=45 MPH           |     |       |      |     |     | V=50 MPH           |     |     |       |      |     |     |     |     |     |  |
|--------------------|------|-----|-----|-----|-----|--------------------|--------|------|-----|-----|-----|--------------------|-----|-------|------|-----|-----|--------------------|-----|-----|-------|------|-----|-----|-----|-----|-----|--|
| Ls for Values of D |      |     |     |     |     | Ls for Values of D |        |      |     |     |     | Ls for Values of D |     |       |      |     |     | Ls for Values of D |     |     |       |      |     |     |     |     |     |  |
| Dc                 | e    | 12  | 18  | 24  | 30  | 36                 | Dc     | e    | 12  | 18  | 24  | 30                 | 36  | Dc    | e    | 12  | 18  | 24                 | 30  | 36  | Dc    | e    | 12  | 18  | 24  | 30  | 36  |  |
| 2°13'              | .020 | 36  | 45  | 55  | 64  | 73                 | 1°21'  | .020 | 41  | 52  | 62  | 72                 | 83  | 1°06' | .020 | 44  | 55  | 67                 | 78  | 89  | 0°55' | .020 | 48  | 60  | 72  | 84  | 96  |  |
| 2°15'              | .020 | 36  | 45  | 55  | 64  | 73                 | 1°30'  | .021 | 43  | 54  | 65  | 76                 | 87  | 1°15' | .021 | 47  | 58  | 70                 | 82  | 94  | 1°00' | .021 | 50  | 63  | 76  | 88  | 101 |  |
| 2°30'              | .021 | 38  | 48  | 57  | 67  | 77                 | 1°45'  | .024 | 50  | 62  | 74  | 87                 | 100 | 1°30' | .025 | 56  | 69  | 83                 | 97  | 112 | 1°15' | .026 | 62  | 78  | 94  | 109 | 125 |  |
| 2°45'              | .022 | 40  | 50  | 60  | 70  | 80                 | 2°00'  | .027 | 56  | 70  | 84  | 98                 | 112 | 1°45' | .029 | 64  | 80  | 97                 | 113 | 130 | 2°00' | .032 | 71  | 89  | 107 | 124 | 143 |  |
| 3°00'              | .024 | 44  | 54  | 65  | 76  | 88                 | 2°15'  | .030 | 62  | 77  | 93  | 109                | 125 | 2°00' | .032 | 71  | 89  | 107                | 124 | 143 | 2°15' | .036 | 80  | 100 | 120 | 140 | 161 |  |
| 3°15'              | .026 | 47  | 59  | 71  | 83  | 95                 | 2°30'  | .032 | 66  | 82  | 99  | 116                | 133 | 2°30' | .039 | 87  | 108 | 130                | 152 | 174 | 2°45' | .042 | 101 | 125 | 151 | 176 | 203 |  |
| 3°30'              | .028 | 51  | 63  | 76  | 89  | 102                | 2°45'  | .035 | 72  | 90  | 109 | 127                | 146 | 2°45' | .042 | 93  | 116 | 140                | 163 | 188 | 2°30' | .046 | 110 | 137 | 166 | 193 | 222 |  |
| 3°45'              | .029 | 53  | 66  | 79  | 92  | 106                | 3°00'  | .038 | 79  | 98  | 118 | 138                | 158 | 3°00' | .045 | 100 | 125 | 150                | 175 | 201 | 2°45' | .049 | 118 | 146 | 176 | 206 | 236 |  |
| 4°00'              | .031 | 56  | 70  | 85  | 99  | 113                | 3°15'  | .040 | 83  | 103 | 124 | 145                | 166 | 3°15' | .048 | 107 | 133 | 160                | 187 | 214 | 3°00' | .052 | 125 | 155 | 187 | 218 | 251 |  |
| 4°15'              | .032 | 58  | 72  | 87  | 102 | 117                | 3°30'  | .043 | 89  | 111 | 133 | 156                | 179 | 3°30' | .050 | 111 | 138 | 167                | 194 | 223 | 3°15' | .055 | 132 | 164 | 198 | 231 | 265 |  |
| 4°30'              | .034 | 62  | 77  | 93  | 108 | 124                | 3°45'  | .045 | 93  | 116 | 140 | 163                | 187 | 3°45' | .053 | 118 | 147 | 177                | 206 | 237 | 3°30' | .058 | 139 | 173 | 209 | 244 | 280 |  |
| 4°45'              | .035 | 64  | 79  | 95  | 111 | 128                | 4°00'  | .047 | 97  | 121 | 146 | 170                | 195 | 4°00' | .055 | 122 | 152 | 183                | 214 | 246 | 3°45' | .061 | 146 | 182 | 220 | 256 | 294 |  |
| 5°00'              | .037 | 67  | 84  | 101 | 118 | 135                | 4°15'  | .049 | 101 | 126 | 152 | 177                | 204 | 4°15' | .057 | 127 | 158 | 190                | 222 | 255 | 4°00' | .063 | 151 | 188 | 227 | 265 | 304 |  |
| 5°30'              | .040 | 73  | 91  | 109 | 127 | 146                | 4°30'  | .051 | 106 | 131 | 158 | 185                | 212 | 4°30' | .059 | 131 | 163 | 197                | 229 | 264 | 4°15' | .066 | 158 | 197 | 238 | 277 | 318 |  |
| 6°00'              | .042 | 76  | 95  | 115 | 134 | 153                | 4°45'  | .053 | 110 | 137 | 164 | 192                | 220 | 4°45' | .061 | 136 | 169 | 203                | 237 | 272 | 4°30' | .068 | 163 | 203 | 245 | 286 | 328 |  |
| 6°30'              | .045 | 82  | 102 | 123 | 143 | 164                | 5°00'  | .054 | 112 | 139 | 168 | 196                | 225 | 5°00' | .063 | 140 | 174 | 210                | 245 | 281 | 4°45' | .070 | 168 | 209 | 252 | 294 | 338 |  |
| 7°00'              | .047 | 85  | 106 | 128 | 150 | 172                | 5°15'  | .056 | 116 | 144 | 174 | 203                | 233 | 5°15' | .065 | 144 | 180 | 217                | 253 | 290 | 5°00' | .071 | 170 | 212 | 256 | 298 | 343 |  |
| 7°30'              | .049 | 89  | 111 | 134 | 156 | 179                | 5°30'  | .058 | 120 | 149 | 180 | 210                | 241 | 5°30' | .066 | 147 | 183 | 220                | 257 | 295 | 5°15' | .073 | 175 | 218 | 263 | 307 | 352 |  |
| 8°00'              | .051 | 93  | 115 | 139 | 162 | 186                | 5°45'  | .059 | 122 | 152 | 183 | 214                | 245 | 5°45' | .068 | 151 | 188 | 227                | 264 | 304 | 5°30' | .074 | 178 | 221 | 266 | 311 | 357 |  |
| 9°00'              | .054 | 98  | 122 | 147 | 172 | 197                | 6°00'  | .061 | 126 | 157 | 189 | 221                | 254 | 6°00' | .069 | 153 | 191 | 230                | 268 | 308 | 5°45' | .076 | 182 | 227 | 274 | 319 | 367 |  |
| 10°00'             | .057 | 104 | 129 | 155 | 181 | 208                | 6°30'  | .063 | 130 | 162 | 196 | 228                | 262 | 6°30' | .071 | 158 | 196 | 237                | 276 | 317 | 6°00' | .077 | 185 | 230 | 277 | 323 | 371 |  |
| 11°00'             | .059 | 107 | 134 | 161 | 188 | 216                | 7°00'  | .066 | 137 | 170 | 205 | 239                | 274 | 7°00' | .074 | 164 | 205 | 247                | 288 | 331 | 6°30' | .079 | 190 | 236 | 284 | 332 | 381 |  |
| 12°00'             | .062 | 113 | 140 | 169 | 197 | 227                | 7°30'  | .068 | 141 | 175 | 211 | 246                | 283 | 7°30' | .076 | 169 | 210 | 253                | 296 | 339 | 7°00' | .080 | 192 | 239 | 288 | 336 | 386 |  |
| 13°00'             | .064 | 116 | 145 | 175 | 204 | 234                | 8°00'  | .070 | 145 | 180 | 217 | 253                | 291 | 8°00' | .078 | 173 | 216 | 260                | 303 | 348 | 7°34' | .080 | 192 | 239 | 288 | 336 | 386 |  |
| 14°00'             | .066 | 120 | 149 | 180 | 210 | 241                | 8°30'  | .072 | 149 | 185 | 223 | 261                | 299 | 8°30' | .079 | 176 | 219 | 263                | 307 | 353 |       |      |     |     |     |     |     |  |
| 15°00'             | .069 | 125 | 156 | 188 | 220 | 252                | 9°00'  | .074 | 153 | 191 | 230 | 268                | 308 | 9°00' | .080 | 178 | 221 | 267                | 311 | 357 |       |      |     |     |     |     |     |  |
| 16°00'             | .070 | 127 | 158 | 191 | 223 | 256                | 9°30'  | .075 | 155 | 193 | 233 | 272                | 312 | 9°46' | .080 | 178 | 221 | 267                | 311 | 357 |       |      |     |     |     |     |     |  |
| 17°00'             | .072 | 131 | 163 | 196 | 229 | 263                | 10°00' | .077 | 159 | 198 | 239 | 279                | 320 |       |      |     |     |                    |     |     |       |      |     |     |     |     |     |  |
| 18°00'             | .074 | 135 | 168 | 202 | 235 | 270                | 11°00' | .079 | 163 | 203 | 245 | 286                | 329 |       |      |     |     |                    |     |     |       |      |     |     |     |     |     |  |
| 20°00'             | .076 | 138 | 172 | 207 | 242 | 278                | 12°00' | .080 | 166 | 206 | 248 | 290                | 333 |       |      |     |     |                    |     |     |       |      |     |     |     |     |     |  |
| 22°00'             | .078 | 142 | 177 | 213 | 248 | 285                | 12°54' | .080 | 166 | 206 | 248 | 290                | 333 |       |      |     |     |                    |     |     |       |      |     |     |     |     |     |  |
| 24°00'             | .079 | 138 | 173 | 207 | 242 | 276                |        |      |     |     |     |                    |     |       |      |     |     |                    |     |     |       |      |     |     |     |     |     |  |
| 26°00'             | .080 | 136 | 170 | 204 | 238 | 272                |        |      |     |     |     |                    |     |       |      |     |     |                    |     |     |       |      |     |     |     |     |     |  |
| 26°46'             | .080 | 130 | 163 | 195 | 228 | 260                |        |      |     |     |     |                    |     |       |      |     |     |                    |     |     |       |      |     |     |     |     |     |  |

| V=55 MPH           |      |     |     |     |     |     |
|--------------------|------|-----|-----|-----|-----|-----|
| Ls for Values of D |      |     |     |     |     |     |
| Dc                 | e    | 12  | 18  | 24  | 30  | 36  |
| 0°46'              | .020 | 51  | 64  | 77  | 89  | 103 |
| 1°00'              | .025 | 64  | 79  | 96  | 112 | 128 |
| 1°15'              | .030 | 77  | 95  | 115 | 134 | 154 |
| 1°30'              | .035 | 89  | 111 | 134 | 156 | 180 |
| 1°45'              | .040 | 102 | 127 | 153 | 179 | 205 |
| 2°00'              | .045 | 115 | 143 | 172 | 201 | 231 |
| 2°15'              | .049 | 125 | 156 | 188 | 219 | 251 |
| 2°30'              | .053 | 135 | 168 | 203 | 237 | 272 |
| 2°45'              | .057 | 146 | 181 | 218 | 255 | 293 |
| 3°00'              | .060 | 153 | 191 | 230 | 268 | 308 |
| 3°15'              | .063 | 161 | 200 | 241 | 281 | 323 |
| 3°30'              | .066 | 169 | 210 | 253 | 295 | 339 |
| 3°45'              | .069 | 176 | 219 | 264 | 308 | 354 |
| 4°00'              | .071 | 181 | 226 | 272 | 317 | 364 |
| 4°15'              | .073 | 186 | 232 | 280 | 326 | 375 |
| 4°30'              | .075 | 191 | 238 | 287 | 335 | 385 |
| 4°45'              | .077 | 197 | 245 | 295 | 344 | 395 |
| 5°00'              | .078 | 199 | 248 | 299 | 349 | 400 |
| 5°15'              | .079 | 202 | 251 | 303 | 353 | 405 |
| 5°30'              | .080 | 204 | 254 | 306 | 357 | 411 |
| 5°58'              | .080 | 204 | 254 | 306 | 357 | 411 |

| V=60 MPH           |      |     |     |     |     |     |
|--------------------|------|-----|-----|-----|-----|-----|
| Ls for Values of D |      |     |     |     |     |     |
| Dc                 | e    | 12  | 18  | 24  | 30  | 36  |
| 0°40'              | .020 | 53  | 66  | 80  | 93  | 107 |
| 0°45'              | .022 | 59  | 73  | 88  | 103 | 118 |
| 1°00'              | .029 | 77  | 96  | 116 | 135 | 155 |
| 1°15'              | .035 | 93  | 116 | 140 | 163 | 188 |
| 1°30'              | .041 | 109 | 136 | 164 | 191 | 220 |
| 1°45'              | .046 | 123 | 153 | 184 | 215 | 247 |
| 2°00'              | .051 | 136 | 169 | 204 | 238 | 273 |
| 2°15'              | .056 | 149 | 186 | 224 | 261 | 300 |
| 2°30'              | .061 | 163 | 203 | 244 | 285 | 327 |
| 2°45'              | .065 | 173 | 216 | 260 | 303 | 348 |
| 3°00'              | .068 | 181 | 226 | 272 | 317 | 364 |
| 3°15'              | .071 | 189 | 236 | 284 | 331 | 381 |
| 3°30'              | .074 | 197 | 246 | 296 | 345 | 397 |
| 3°45'              | .076 | 203 | 252 | 304 | 355 | 407 |
| 4°00'              | .078 | 208 | 259 | 312 | 364 | 418 |
| 4°15'              | .079 | 211 | 262 | 316 | 369 | 423 |
| 4°30'              | .080 | 213 | 266 | 320 | 373 | 429 |
| 4°46'              | .080 | 213 | 266 | 320 | 373 | 429 |

| V=65 MPH           |      |     |     |     |     |     |
|--------------------|------|-----|-----|-----|-----|-----|
| Ls for Values of D |      |     |     |     |     |     |
| Dc                 | e    | 12  | 18  | 24  | 30  | 36  |
| 0°36'              | .020 | 56  | 69  | 84  | 98  | 112 |
| 0°45'              | .025 | 70  | 87  | 105 | 122 | 140 |
| 1°00'              | .032 | 89  | 111 | 134 | 156 | 179 |
| 1°15'              | .039 | 109 | 136 | 163 | 190 | 219 |
| 1°30'              | .046 | 128 | 160 | 193 | 225 | 258 |
| 1°45'              | .052 | 145 | 181 | 218 | 254 | 292 |
| 2°00'              | .058 | 162 | 202 | 243 | 283 | 325 |
| 2°15'              | .063 | 176 | 219 | 264 | 308 | 353 |
| 2°30'              | .068 | 190 | 236 | 285 | 332 | 381 |
| 2°45'              | .072 | 201 | 250 | 301 | 352 | 404 |
| 3°00'              | .075 | 209 | 261 | 314 | 366 | 421 |
| 3°15'              | .078 | 218 | 271 | 327 | 381 | 438 |
| 3°30'              | .079 | 220 | 274 | 331 | 386 | 443 |
| 3°52'              | .080 | 223 | 278 | 335 | 391 | 449 |

| V=70 MPH           |      |     |     |     |     |     |
|--------------------|------|-----|-----|-----|-----|-----|
| Ls for Values of D |      |     |     |     |     |     |
| Dc                 | e    | 12  | 18  | 24  | 30  | 36  |
| 0°32'              | .020 | 60  | 75  | 90  | 105 | 121 |
| 0°45'              | .027 | 81  | 101 | 122 | 142 | 163 |
| 1°00'              | .036 | 108 | 134 | 162 | 189 | 217 |
| 1°15'              | .044 | 132 | 164 | 198 | 231 | 265 |
| 1°30'              | .051 | 153 | 190 | 230 | 268 | 308 |
| 1°45'              | .058 | 174 | 217 | 261 | 305 | 350 |
| 2°00'              | .065 | 195 | 243 | 293 | 341 | 392 |
| 2°15'              | .071 | 213 | 265 | 320 | 373 | 428 |
| 2°30'              | .075 | 225 | 280 | 338 | 394 | 452 |
| 2°45'              | .078 | 234 | 291 | 351 | 410 | 470 |
| 3°00'              | .080 | 240 | 299 | 360 | 420 | 482 |
| 3°10'              | .080 | 240 | 299 | 360 | 420 |     |

**TABLE 202.3D**  
**Superelevation Rates and Transition Lengths for  $e_{max} = 0.100$  ft/ft**

| V=30 MPH |      |                    |     |     |     | V=40 MPH |        |                    |     |     |     | V=45 MPH |     |                    |      |     |     | V=50 MPH |     |                    |       |      |     |     |     |     |     |
|----------|------|--------------------|-----|-----|-----|----------|--------|--------------------|-----|-----|-----|----------|-----|--------------------|------|-----|-----|----------|-----|--------------------|-------|------|-----|-----|-----|-----|-----|
|          |      | Ls for Values of D |     |     |     |          |        | Ls for Values of D |     |     |     |          |     | Ls for Values of D |      |     |     |          |     | Ls for Values of D |       |      |     |     |     |     |     |
| Dc       | e    | 12                 | 18  | 24  | 30  | 36       | Dc     | e                  | 12  | 18  | 24  | 30       | 36  | Dc                 | e    | 12  | 18  | 24       | 30  | 36                 | Dc    | e    | 12  | 18  | 24  | 30  | 36  |
| 2°13'    | .020 | 36                 | 45  | 55  | 64  | 73       | 1°21'  | .020               | 41  | 52  | 62  | 72       | 83  | 1°06'              | .020 | 44  | 55  | 67       | 78  | 89                 | 0°55' | .020 | 48  | 60  | 72  | 84  | 96  |
| 2°15'    | .020 | 36                 | 45  | 55  | 64  | 73       | 1°30'  | .021               | 43  | 54  | 65  | 76       | 87  | 1°15'              | .022 | 49  | 61  | 73       | 86  | 98                 | 1°00' | .021 | 50  | 63  | 76  | 88  | 101 |
| 2°30'    | .021 | 38                 | 48  | 57  | 67  | 77       | 1°45'  | .025               | 52  | 64  | 78  | 91       | 104 | 1°30'              | .026 | 58  | 72  | 87       | 101 | 116                | 1°15' | .026 | 62  | 78  | 94  | 109 | 125 |
| 2°45'    | .023 | 42                 | 52  | 63  | 73  | 84       | 2°00'  | .028               | 58  | 72  | 87  | 101      | 116 | 1°45'              | .030 | 67  | 83  | 100      | 117 | 134                | 1°30' | .031 | 74  | 93  | 112 | 130 | 150 |
| 3°00'    | .025 | 45                 | 57  | 68  | 80  | 91       | 2°15'  | .031               | 64  | 80  | 96  | 112      | 129 | 2°00'              | .034 | 76  | 94  | 113      | 132 | 152                | 1°45' | .036 | 86  | 108 | 130 | 151 | 174 |
| 3°15'    | .027 | 49                 | 61  | 74  | 86  | 99       | 2°30'  | .034               | 70  | 88  | 106 | 123      | 141 | 2°15'              | .038 | 84  | 105 | 127      | 148 | 170                | 2°00' | .040 | 96  | 120 | 144 | 168 | 193 |
| 3°30'    | .029 | 53                 | 66  | 79  | 92  | 106      | 2°45'  | .037               | 77  | 95  | 115 | 134      | 154 | 2°30'              | .041 | 91  | 113 | 137      | 159 | 183                | 2°15' | .041 | 146 | 182 | 220 | 256 | 294 |
| 3°45'    | .031 | 56                 | 70  | 85  | 99  | 113      | 3°00'  | .040               | 83  | 103 | 124 | 145      | 166 | 2°45'              | .045 | 100 | 125 | 150      | 175 | 201                | 2°30' | .049 | 118 | 146 | 176 | 206 | 236 |
| 4°00'    | .032 | 58                 | 72  | 87  | 102 | 117      | 3°15'  | .043               | 89  | 111 | 133 | 156      | 179 | 3°00'              | .048 | 107 | 133 | 160      | 187 | 214                | 2°45' | .053 | 127 | 158 | 191 | 223 | 256 |
| 4°15'    | .034 | 62                 | 77  | 93  | 108 | 124      | 3°30'  | .045               | 93  | 116 | 140 | 163      | 187 | 3°15'              | .051 | 113 | 141 | 170      | 198 | 228                | 3°00' | .057 | 137 | 170 | 205 | 239 | 275 |
| 4°30'    | .036 | 65                 | 81  | 98  | 115 | 132      | 3°45'  | .048               | 99  | 124 | 149 | 174      | 200 | 3°30'              | .055 | 122 | 152 | 183      | 214 | 246                | 3°15' | .061 | 146 | 182 | 220 | 256 | 294 |
| 4°45'    | .038 | 69                 | 86  | 104 | 121 | 139      | 4°00'  | .051               | 106 | 131 | 158 | 185      | 212 | 3°45'              | .058 | 129 | 160 | 193      | 226 | 259                | 3°30' | .064 | 154 | 191 | 230 | 269 | 309 |
| 5°00'    | .039 | 71                 | 88  | 106 | 124 | 143      | 4°15'  | .053               | 110 | 137 | 164 | 192      | 220 | 4°00'              | .061 | 136 | 169 | 203      | 237 | 272                | 3°45' | .068 | 163 | 203 | 245 | 286 | 328 |
| 5°15'    | .041 | 75                 | 93  | 112 | 130 | 150      | 4°30'  | .056               | 116 | 144 | 174 | 203      | 233 | 4°15'              | .064 | 142 | 177 | 213      | 249 | 286                | 4°00' | .071 | 170 | 212 | 256 | 298 | 343 |
| 5°30'    | .042 | 76                 | 95  | 115 | 134 | 153      | 4°45'  | .058               | 120 | 149 | 180 | 210      | 241 | 4°30'              | .066 | 147 | 183 | 220      | 257 | 295                | 4°15' | .075 | 180 | 224 | 270 | 315 | 362 |
| 6°00'    | .045 | 82                 | 102 | 123 | 143 | 164      | 5°00'  | .060               | 124 | 155 | 186 | 217      | 250 | 4°45'              | .069 | 153 | 191 | 230      | 268 | 308                | 4°30' | .078 | 187 | 233 | 281 | 328 | 376 |
| 6°30'    | .048 | 87                 | 109 | 131 | 153 | 175      | 5°15'  | .063               | 130 | 162 | 196 | 228      | 262 | 5°00'              | .072 | 160 | 199 | 240      | 280 | 322                | 4°45' | .081 | 194 | 242 | 292 | 340 | 391 |
| 7°00'    | .051 | 93                 | 115 | 139 | 162 | 186      | 5°30'  | .065               | 134 | 167 | 202 | 235      | 270 | 5°15'              | .074 | 164 | 205 | 247      | 288 | 331                | 5°00' | .083 | 199 | 248 | 299 | 349 | 400 |
| 7°30'    | .054 | 98                 | 122 | 147 | 172 | 197      | 5°45'  | .067               | 139 | 173 | 208 | 243      | 279 | 5°30'              | .077 | 171 | 213 | 257      | 299 | 344                | 5°15' | .086 | 206 | 257 | 310 | 361 | 415 |
| 8°00'    | .057 | 104                | 129 | 155 | 181 | 208      | 6°00'  | .069               | 143 | 178 | 214 | 250      | 287 | 5°45'              | .079 | 176 | 219 | 263      | 307 | 353                | 5°30' | .088 | 211 | 263 | 317 | 370 | 425 |
| 8°30'    | .059 | 107                | 134 | 161 | 188 | 216      | 6°30'  | .073               | 151 | 188 | 227 | 264      | 304 | 6°00'              | .081 | 180 | 224 | 270      | 315 | 362                | 5°45' | .090 | 216 | 269 | 324 | 378 | 434 |
| 9°00'    | .061 | 111                | 138 | 166 | 194 | 223      | 7°00'  | .078               | 157 | 196 | 236 | 275      | 316 | 6°30'              | .085 | 189 | 235 | 283      | 331 | 380                | 6°00' | .092 | 221 | 275 | 331 | 386 | 444 |
| 9°30'    | .063 | 115                | 143 | 172 | 200 | 230      | 7°30'  | .080               | 166 | 206 | 248 | 290      | 333 | 7°00'              | .088 | 196 | 243 | 293      | 342 | 393                | 6°15' | .094 | 226 | 281 | 338 | 395 | 453 |
| 10°00'   | .066 | 120                | 149 | 180 | 210 | 241      | 8°00'  | .083               | 172 | 214 | 258 | 301      | 345 | 7°30'              | .091 | 202 | 252 | 303      | 354 | 406                | 6°30' | .095 | 228 | 284 | 342 | 399 | 458 |
| 11°00'   | .069 | 125                | 156 | 188 | 220 | 252      | 8°30'  | .085               | 176 | 219 | 264 | 308      | 353 | 8°00'              | .094 | 209 | 260 | 313      | 366 | 420                | 7°00' | .098 | 235 | 293 | 353 | 412 | 473 |
| 12°00'   | .073 | 133                | 165 | 199 | 232 | 267      | 9°00'  | .088               | 182 | 227 | 273 | 319      | 366 | 8°30'              | .096 | 213 | 266 | 320      | 373 | 429                | 7°30' | .099 | 238 | 296 | 356 | 416 | 478 |
| 13°00'   | .076 | 138                | 172 | 207 | 242 | 278      | 9°30'  | .090               | 186 | 232 | 279 | 326      | 374 | 9°00'              | .098 | 218 | 271 | 327      | 381 | 438                | 8°15' | .100 | 235 | 294 | 353 | 411 | 470 |
| 14°00'   | .079 | 144                | 179 | 215 | 251 | 289      | 10°00' | .092               | 190 | 237 | 286 | 333      | 383 | 10°37'             | .100 | 207 | 259 | 311      | 362 | 414                |       |      |     |     |     |     |     |
| 15°00'   | .082 | 149                | 186 | 224 | 261 | 300      | 10°30' | .094               | 194 | 242 | 292 | 340      | 391 |                    |      |     |     |          |     |                    |       |      |     |     |     |     |     |
| 16°00'   | .084 | 153                | 190 | 229 | 267 | 307      | 11°00' | .096               | 199 | 247 | 298 | 348      | 399 |                    |      |     |     |          |     |                    |       |      |     |     |     |     |     |
| 17°00'   | .087 | 158                | 197 | 237 | 277 | 318      | 12°00' | .098               | 194 | 243 | 291 | 340      | 388 |                    |      |     |     |          |     |                    |       |      |     |     |     |     |     |
| 18°00'   | .089 | 159                | 199 | 239 | 278 | 318      | 13°58' | .100               | 180 | 225 | 270 | 315      | 360 |                    |      |     |     |          |     |                    |       |      |     |     |     |     |     |
| 20°00'   | .093 | 151                | 189 | 227 | 264 | 302      |        |                    |     |     |     |          |     |                    |      |     |     |          |     |                    |       |      |     |     |     |     |     |
| 22°00'   | .096 | 144                | 180 | 216 | 252 | 288      |        |                    |     |     |     |          |     |                    |      |     |     |          |     |                    |       |      |     |     |     |     |     |
| 24°00'   | .098 | 138                | 173 | 207 | 242 | 276      |        |                    |     |     |     |          |     |                    |      |     |     |          |     |                    |       |      |     |     |     |     |     |
| 26°00'   | .099 | 132                | 165 | 198 | 231 | 264      |        |                    |     |     |     |          |     |                    |      |     |     |          |     |                    |       |      |     |     |     |     |     |
| 28°39'   | .100 | 126                | 158 | 189 | 221 | 252      |        |                    |     |     |     |          |     |                    |      |     |     |          |     |                    |       |      |     |     |     |     |     |

| V=55 MPH |      |                    |     |     |     | V=60 MPH |       |                    |     |     |     | V=65 MPH |     |                    |      |     |       | V=70 MPH |     |                    |       |      |     |     |     |     |     |
|----------|------|--------------------|-----|-----|-----|----------|-------|--------------------|-----|-----|-----|----------|-----|--------------------|------|-----|-------|----------|-----|--------------------|-------|------|-----|-----|-----|-----|-----|
|          |      | Ls for Values of D |     |     |     |          |       | Ls for Values of D |     |     |     |          |     | Ls for Values of D |      |     |       |          |     | Ls for Values of D |       |      |     |     |     |     |     |
| Dc       | e    | 12                 | 18  | 24  | 30  | 36       | Dc    | e                  | 12  | 18  | 24  | 30       | 36  | Dc                 | e    | 12  | 18    | 24       | 30  | 36                 | Dc    | e    | 12  | 18  | 24  | 30  | 36  |
| 0°46'    | .020 | 51                 | 64  | 77  | 89  | 103      | 0°40' | .020               | 53  | 66  | 80  | 93       | 107 | 0°36'              | .020 | 56  | 69    | 84       | 98  | 112                | 0°32' | .020 | 60  | 75  | 90  | 105 | 121 |
| 1°00'    | .025 | 64                 | 79  | 96  | 112 | 128      | 0°45' | .022               | 59  | 73  | 88  | 103      | 118 | 0°45'              | .025 | 70  | 87    | 105      | 122 | 140                | 0°45' | .028 | 84  | 105 | 126 | 147 | 169 |
| 1°15'    | .031 | 79                 | 99  | 119 | 139 | 159      | 1°00' | .030               | 80  | 100 | 120 | 140      | 161 | 1°00'              | .033 | 92  | 115   | 138      | 161 | 185                | 1°00' | .037 | 111 | 138 | 167 | 194 | 223 |
| 1°30'    | .037 | 94                 | 118 | 142 | 165 | 190      | 1°15' | .036               | 96  | 120 | 144 | 168      | 193 | 1°15'              | .041 | 114 | 142   | 172      | 200 | 230                | 1°15' | .046 | 138 | 172 | 207 | 242 | 277 |
| 1°45'    | .042 | 107                | 134 | 161 | 188 | 216      | 1°30' | .043               | 115 | 143 | 172 | 201      | 230 | 1°30'              | .048 | 134 | 167   | 201      | 234 | 269                | 1°30' | .054 | 162 | 202 | 243 | 284 | 326 |
| 2°00'    | .047 | 120                | 149 | 180 | 210 | 241      | 1°45' | .049               | 131 | 163 | 196 | 229      | 263 | 1°45'              | .055 | 153 | 191   | 230      | 269 | 309                | 1°45' | .062 | 186 | 232 | 279 | 326 | 374 |
| 2°15'    | .053 | 135                | 168 | 203 | 237 | 272      | 2°00' | .055               | 147 | 183 | 220 | 257      | 295 | 2°00'              | .062 | 173 | 215   | 260      | 303 | 348                | 2°00' | .070 | 210 | 261 | 315 | 368 | 422 |
| 2°30'    | .057 | 146                | 181 | 218 | 255 | 293      | 2°15' | .061               | 163 | 203 | 244 | 285      | 327 | 2°15'              | .069 | 193 | 240   | 289      | 337 | 387                | 2°15' | .078 | 234 | 291 | 351 | 410 | 470 |
| 2°45'    | .062 | 158                | 197 | 237 | 277 | 318      | 2°30' | .066               | 176 | 219 | 264 | 308      | 354 | 2°30'              | .075 | 209 | 261   | 314      | 366 | 421                | 2°30' | .085 | 255 | 317 | 383 | 446 | 513 |
| 3°00'    | .067 | 171                | 213 | 257 | 299 | 344      | 2°45' | .072               | 192 | 239 | 288 | 336      | 386 | 2°45'              | .081 | 226 | 281   | 339      | 396 | 454                | 2°45' | .091 | 273 | 340 | 410 | 478 | 549 |
| 3°15'    | .071 | 181                | 226 | 272 | 317 | 364      | 3°00' | .077               | 205 | 256 | 308 | 359      | 413 | 3°00'              | .087 | 243 | 302   | 364      | 425 | 488                | 3°00' | .096 | 297 | 370 | 446 | 520 | 597 |
| 3°30'    | .075 | 191                | 238 | 287 | 335 | 385      | 3°15' | .082               | 219 | 272 | 328 | 383      | 440 | 3°15'              | .091 | 254 | 316   | 381      | 444 | 510                | 3°15' | .099 | 300 | 374 | 450 | 525 | 603 |
| 3°45'    | .079 | 202                | 251 | 303 | 353 | 405      | 3°30' | .086               | 229 | 286 | 344 | 401      | 461 | 3°30'              | .095 | 265 | 330   | 398      | 464 | 533                | 3°30' | .100 | 300 | 374 | 450 | 525 | 603 |
| 4°00'    | .082 | 209                | 261 | 314 | 366 | 421      | 3°45' | .090               | 240 | 299 | 360 | 420      | 482 | 3°45'              | .098 | 273 | 340   | 410      | 479 | 550                |       |      |     |     |     |     |     |
| 4°15'    | .086 | 220                | 273 | 329 | 384 | 441      | 4°00' | .093               | 248 | 309 | 372 | 434      | 498 | 4°00'              | .099 | 276 | 344   | 414      | 483 | 555                |       |      |     |     |     |     |     |
| 4°30'    | .089 | 227                | 283 | 341 | 398 | 457      | 4°15' | .095               | 253 | 315 | 380 | 443      | 509 | 4°17'              | .100 | 279 | 347</ |          |     |                    |       |      |     |     |     |     |     |

## **203 - Horizontal Alignment**

### **203.1 - General**

The guidelines which follow are applicable to curvature on both two-lane and multi-lane highways:

**The horizontal alignment control line shall coincide with the superelevation axis of rotation; and**

**Horizontal alignment shall provide at least the minimum stopping sight distance shown in [Figure 201.2](#) at all points on the highway.**

The proper design of highway horizontal alignment takes into consideration safety, vertical alignment, type of facility, design speed, topography, right-of-way, intersections, environmental factors and construction cost. Safety is always the objective in highway design.

Topography not only influences horizontal and vertical curvature but also design speed which, in turn, controls sight distance. Sight distance must be considered concurrently with topography because it often requires a greater curve radius than that required solely by design speed.

Proper coordination of horizontal and vertical alignments increases highway safety, improves driver comfort, encourages uniform speed, and improves appearance. All of these factors must be balanced to provide a highway design which is safe, cost effective and in harmony with its location.

### **203.2 - Horizontal Curvature**

The maximum degree of curvature to be used is a function of design speed and maximum rate of superelevation. Tables 202.3A-D give the degree of curvature for the various combinations of design speed and maximum superelevation. These degrees of curvature are based on driver comfort and may not provide the sight distance required for the design speed.

The maximum degree of curvature based on stopping sight distance and minimum horizontal distance to a sight obstruction are shown in [Figure 203.2](#). These values may control in cut sections or where there are bridge piers, sound walls, longitudinal barriers, and other similar features close to the shoulders. The implications of future widening should also be evaluated.

The minimum degree of curvature should be  $0^{\circ}15'$ , equivalent to a radius of 22,920 ft.

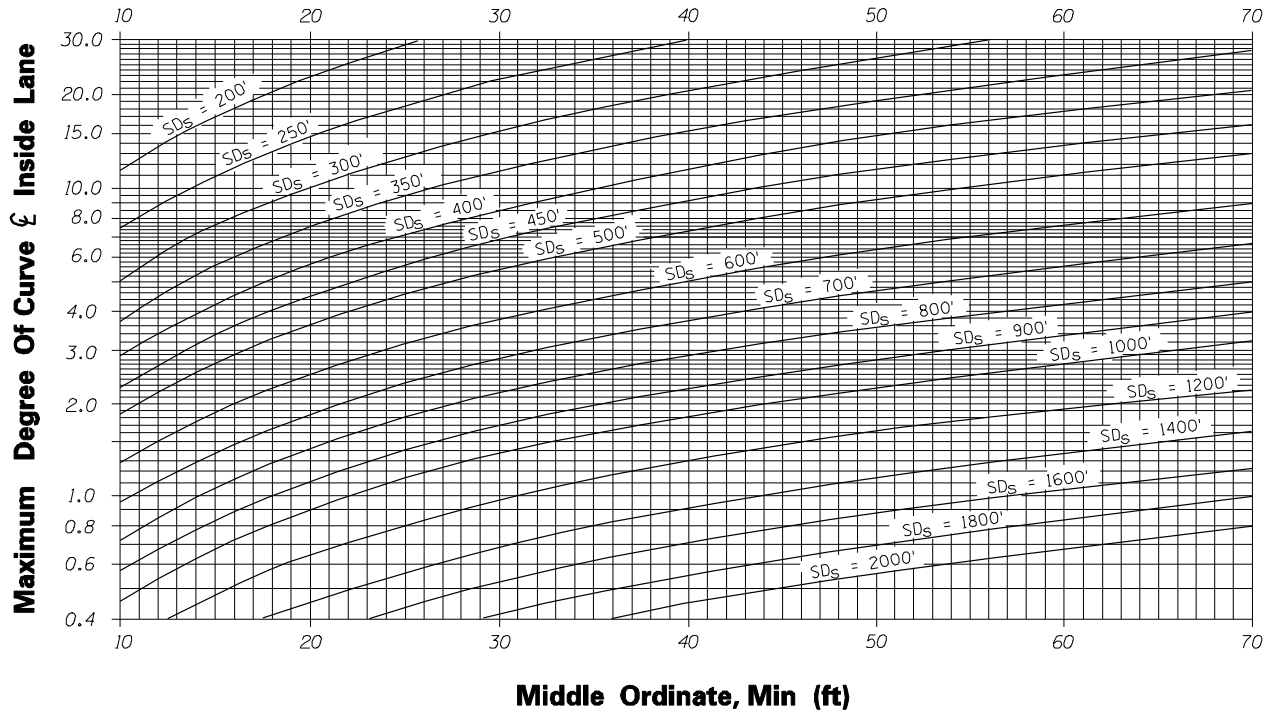

**NOTE**

See Figure 201.2 for Stopping Sight Distance ( $SD_s$ )  
 See Tables 202.3 A, B, C & D for Degree of Curvature and Superelevation

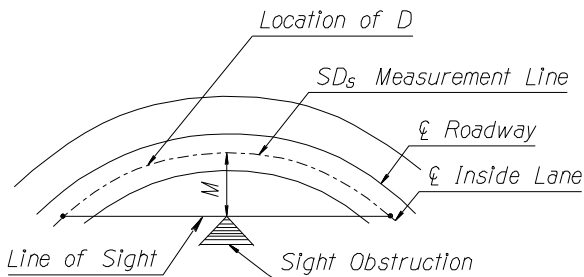

**MIDDLE ORDINATE :**

$$M = \frac{5730}{D} \left( 1 - \cos \left( \frac{SD_s D}{200} \right) \right)$$

Where:

- $M$  = Length of Middle Ordinate, Min (ft)
- $SD_s$  = Stopping Sight Distance (ft) Along Centerline of Inside Lane
- $D$  = Maximum Degree of Curvature on Center Line of Inside Lane

For  $M$  Using Radius - See AASHTO Formula 3-38

**STOPPING SIGHT DISTANCE HORIZONTAL CURVES**  
**FIGURE 203.2**

### 203.3 - Spiral Transitions

Spiral transition curves simulate the path the driver of a motor vehicle would traverse entering a circular curve from a tangent roadway. The Euler curve describes a curve that varies uniformly throughout its length from an infinite radius (tangent) to the radius of the circular curve it transitions to. Experience in Arizona has shown the use of spiral transition curves increases driver comfort and indirectly improves highway operations. ADOT uses the minimum length of spiral transition curve given by AASHTO Eq. 3-27 (C=2) when it exceeds the length necessary to satisfy the maximum relative gradient criteria.

Spirals, as commonly used, cannot be expressed with exactness. The mathematical approximations used to describe spirals are sufficient for establishing the roadway centerline alignment, but imprecision's occur in working with the parallel spirals and offsets necessary to establish ties to ramps, over-crossings and rights-of-way. The impacts of these imprecision's are most often felt in the computations of complex interchanges and restricted rights-of-way in urban areas.

It is common practice to use simple curves without spiral transitions in urban areas particularly on controlled access highways and multi-lane roadways. On urban arterial highways with full shoulders, it is also desirable to use only simple curves without spiral transitions.

The heavy line shown in Tables 202.3A-D indicating the use of spirals is consistent with AASHTO Exhibit 3-33.

**Spiraled curves shall be used as indicated in [Tables 202.3B-D](#)** except that spirals are optional on urban highways under the conditions described above.

The length of the spiral transitions should be the same as the superelevation transition length. The lengths shown in the tables for spiral transitions are also to be used for circular curve transitions. Where conditions require transition lengths other than those given in the tables, the lengths determined for superelevation transitions should be used for the spiral transitions also.

### 203.4 - Alignment Consistency

It is important to maintain a consistency of standards throughout the length of highway. Changes in standards may be appropriate to meet design constraints, however, sudden reductions in standards introduce an element of surprise to the driver and should be avoided. If reductions in standards are required, the design speed between successive curves should not vary by more than 10 mph. Introduction of a curve with a design speed less than the design speed of the project should be avoided at the end of a long tangent, on long downhill grades or at other locations where there is a likelihood of high approach speeds.

Consistency should be maintained within a given design speed. Sharp curves at the higher end of those allowable for the design speed should not be introduced immediately following a series of flat curves and long tangents. Where a sharp curve must be used, it should be approached through a series of successively sharper curves from the flat curvature.

### **203.5 - Central Angle and Curve Length**

The discussion of horizontal alignment in [Section 203](#) is based upon the philosophy of designing a total project. That is, no element of the alignment stands alone. Each curve, each tangent must be looked at in light of its neighboring elements. Nowhere is this philosophy more apparent than in the establishment of central angles for curves and the lengths of curves. The adjustment of one curve to meet central angle, degree of curvature, and length criteria will be reflected in the adjacent curves which, in turn, may need to be adjusted. The process continues until the entire alignment meets the criteria.

In general, the central angle of each curve should be as small as the physical conditions permit so that the highway will be as directional as possible. However, very small central angles will require either very flat curves or short curves, neither of which is desirable.

Therefore, curves with central angles of less than  $2^\circ$  should not be used.

Occasionally, there is a need to incorporate a small angle break in the alignment such as when the highway is to follow section lines or when a small angle break is used to tie into an existing alignment. An angle break (central angles of 45 minutes or less) may be made without using a horizontal curve. A series of closely spaced angle breaks should not be used in place of or to simulate a horizontal curve.

Curves should be at least 500 ft long for a central angle of 5 degrees, and the minimum length should be increased 100 ft for each 1 degree decrease in the central angle.

For main roadways the minimum length of horizontal curve should be fifteen times the design speed (in mph).

### **203.6 - Compound Curves**

A compound curve should be avoided, particularly when a simple curve can be obtained at small extra cost. When used on a two-way roadway, the longer radius should be no more than one-and-one-half times the shorter radius. On one-way roads, such as ramps, the difference in radii of compound curves is not so important if the second curve is flatter than the first. (See [Chapter 500](#) for additional compound curve criteria on interchange ramps.)

The total arc length of a compound curve should meet the criteria given in [Section 203.5](#).

### **203.7 - Reverse Curves**

Reverse curves should be avoided. If used, reverse simple curves should have a tangent between them which allows the superelevation runoff length (Ls) for each curve to be applied to each curve from its standard location without overlapping (see [Figure 202.3A](#)). If this is not possible, the superelevation rate change of 0.06 ft/ft per 100 ft govern ([Section 202.3C](#)). Drainage requirements are also prime considerations in the design of reverse curves. Ls values may be increased to facilitate a smooth transition from full superelevation on one curve to full superelevation on the adjacent curve.

### **203.8 - Broken Back Curves**

A broken back curve consists of two curves in the same direction connected by a short tangent. Broken back curves are unsightly and undesirable. Generally, a single curve can be used.

### **203.9 - Alignment at Bridges**

Superelevation transitions on bridges almost always result in an unsightly appearance of the bridge deck and the bridge rail. Horizontal curves should begin and end sufficiently beyond the bridge limits such that the superelevation transition does not fall on the bridge or its approach and anchor slabs.

## **204 - Vertical Alignment**

### **204.1 - General**

Highways should be designed to encourage uniform operation throughout. For most highway design parameters, uniformity is derived from design speed, e.g., sight distance and horizontal curvature. The relationships between design speed and these design parameters have been developed over the years from empirical data and are generally accepted. Designing for operational uniformity with these parameters is reasonably straight forward--it is essentially a technical process.

With vertical alignment, designing for operational uniformity is less technically precise. Studies have been made which empirically relate grades, lengths of grades and vehicle operating characteristics. Design speed relationships can be derived from these studies; however, the application of these relationships is less a science than, say, for horizontal curves. The combining of two-dimensional horizontal and vertical alignments into a well designed three-dimensional highway requires a higher degree of good engineering judgment.

For the sake of driver expectancy, the designer should try to maintain consistency between similar design features on the same highway segment. A reconstructed portion of an existing highway segment or a spot improvement should not have features designed either to a much higher or lower standard than adjacent portions of the highway.

## 204.2 - General Guidelines

A) *Profile gradeline*: The profile gradeline is the reference line by which the elevation of the pavement and other highway features are established. It is controlled mainly by topography with significant influences from horizontal alignment, type of highway, safety, sight distance, drainage, aesthetics, environmental/cultural concerns, vehicle performance, and construction costs.

**The profile gradeline shall coincide with the axis of rotation for superelevation.**

When alternative profile gradelines are investigated, economic and environmental impact comparisons should be made of each.

The profile gradeline should fit but not follow the terrain. A smooth profile gradeline with gradual changes consistent with the character of the type of highway and the character of the terrain is preferred over a profile gradeline with short tangents and frequent breaks.

The roller-coaster type of profile gradeline should be avoided. Not only is it aesthetically unpleasing, but highways with this type of profile gradeline are difficult to drive. On two-lane roads, the numerous dips inherent in this type of profile gradeline can reduce passing opportunities.

Where intersections occur on highway sections with moderate to steep grades, it is desirable to reduce the gradient through the intersection.

Long, continuous grades should be avoided particularly if the grade is near the allowable maximum. Flatter grades should be used near the top of the ascent. The grade can be broken by including intervals of decreasing grades. The steeper grades should be placed near the bottom of the ascent.

B) *Sight distance*: **All portions of the profile gradeline shall meet stopping sight distance requirements for the design speed of the highway.**

**204.3 - Grades**

A) *Minimum grades:* The desirable minimum grade for a highway with a curb and gutter section is 0.4 percent. Special care should be taken in checking storm water drainage requirements to keep the spread of water on the traveled way within tolerable limits.

**Above 4000 ft elevation the minimum grade for roadways with curb and gutter shall be 0.5 percent.**

Level grades may be used on rural highways below 4000 ft elevation with adequate roadway crown and with proper consideration of drainage requirements.

B) *Maximum grades:* The maximum grades which may be used are shown in Table 204.3 for each type of highway and its allowable range of design speeds.

**Exceptions to the maximums shown in Table 204.3 shall require the approval of the Assistant State Engineer, Roadway Engineering Group.**

**Table 204.3**  
**Relation of Highway Types to**  
**Maximum Grades**

| Conditions                         | Design Speed (mph)      |     |     |    |           |           |           |           |           |
|------------------------------------|-------------------------|-----|-----|----|-----------|-----------|-----------|-----------|-----------|
|                                    | 30                      | 40  | 45  | 50 | 55        | 60        | 65        | 70        | 75        |
| <b>Controlled Access Highways</b>  |                         |     |     |    |           |           |           |           |           |
| Level Terrain                      |                         |     |     |    |           |           | 3%        | 3%        | <b>3%</b> |
| Rolling Terrain                    |                         |     |     |    |           |           | 4%        | 4%        | <b>4%</b> |
| Mountainous Terrain                |                         |     |     | 6% | 6%        | 6%        | <b>5%</b> |           |           |
| Urban/Fringe Urban Areas           |                         |     |     | 4% | 3%        | 3%        | <b>3%</b> |           |           |
| <b>Rural Divided Highways</b>      |                         |     |     |    |           |           |           |           |           |
| Level Terrain                      |                         |     |     |    |           | 3%        | 3%        | <b>3%</b> |           |
| Rolling Terrain                    |                         |     |     |    | 5%        | 4%        | <b>4%</b> |           |           |
| Mountainous Terrain                |                         |     |     | 7% | 7%        | <b>6%</b> |           |           |           |
| <b>Rural Non-Divided Highways</b>  |                         |     |     |    |           |           |           |           |           |
| Level Terrain                      |                         |     |     |    |           | 3%        | 3%        | <b>3%</b> |           |
| Rolling Terrain                    |                         |     |     | 5% | 4%        | 4%        | <b>4%</b> |           |           |
| Mountainous Terrain                |                         |     |     | 7% | <b>7%</b> | 6%        |           |           |           |
| <b>Urban/Fringe Urban Highways</b> |                         |     |     |    |           |           |           |           |           |
|                                    | <b>Arterial Streets</b> |     |     |    |           |           |           |           |           |
| Level Terrain                      | 8%                      | 7%  | 6½% | 6% | 5         | 5         |           |           |           |
| Rolling Terrain                    | 9%                      | 8%  | 7½% | 7% | 6         | 6         |           |           |           |
| Mountainous Terrain                | 11%                     | 10% | 9½% | 9% | 8         | 8         |           |           |           |

Note: Maximum grades shown in **bold** correspond to the design speed for given conditions, see [Table 101.3](#). Grades at other design speeds are for information only.

## 204.4 - Vertical Curves

A) *General:* Vertical curves should be simple in application and result in a design which is safe, comfortable in operation, pleasing in appearance, and adequate for drainage. In any design the sight distance should be as long as possible and, wherever practical, above the minimum stopping distance for the design speed.

**The maximum algebraic difference in adjacent tangent grades without a vertical curve shall be 0.2 percent for a design speed of 50 mph and above. An algebraic difference of 0.4 percent is allowable for design speeds of 45 mph and below.**

B) *Minimum Length:* [Figures 204.4A](#) and [204.4B](#) give minimum lengths of crest vertical curves based on stopping sight distance and passing sight distance requirements respectively. When a vehicle traverses a sag vertical curve at night the portion of highway lighted ahead is dependent upon the position of the headlights and the direction of the light beam. Assumed design values are a headlight height of 2 ft and a one degree upward divergence of the light beam from the longitudinal axis of the vehicle. For overall safety on highways, a sag vertical curve should be long enough so that the light beam distance is nearly the same as the stopping sight distance. [Figure 204.4C](#) gives minimum lengths of sag vertical curves based on the above requirements.

In addition to the above sight distance requirements, vertical curves should satisfy the minimum length requirements shown in Table 204.4.

| <b>Table 204.4</b>   |                             |
|--|-----------------------------|
| <b>Relation of Highway Types to Vertical Curve Minimum Lengths</b> |                             |
| Highway Types  | Min Length(ft)              |
| Controlled Access Highways   |                             |
| Rural Areas  | 1000                        |
| Urban Areas  | 800                         |
| Rural Highways   | 800                         |
| Urban Highways   | three times<br>design speed |

Note: For ramps refer to [Chapter 500](#)

C) *Broken Back Vertical Curves:* Broken back vertical curves consist of two vertical curves in the same direction separated by a short tangent grade section. Profile gradelines with broken back curves should be avoided, particularly in sag vertical curves where the unpleasing alignment is in full view.

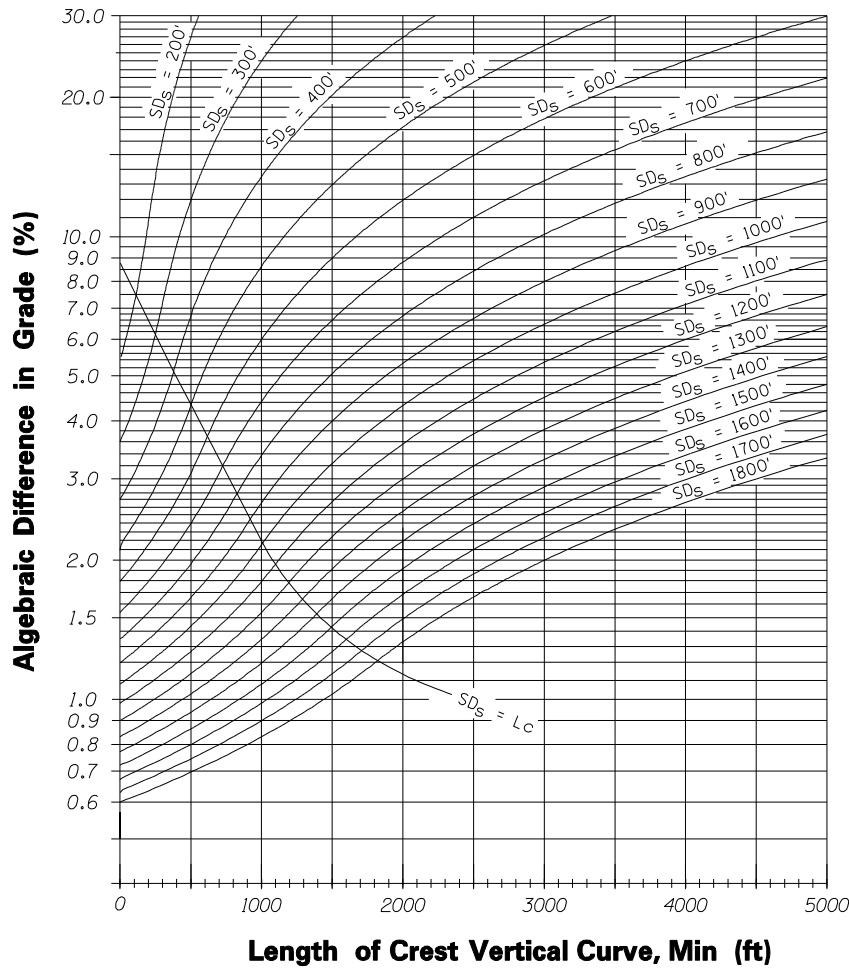

For  $SD_s < L_c$  
$$L_c = \frac{A(SD_s)^2}{2158}$$

Where:  
 $SD_s$  = Stopping Sight Distance, (ft)  
 $L_c$  = Length of Crest Vertical Curve, Min (ft)  
 $A$  = Algebraic Difference in Grade, (%)

For  $SD_s > L_c$  
$$L_c = 2(SD_s) - \frac{2158}{A}$$

**RELATION OF MINIMUM LENGTH OF CREST VERTICAL CURVES TO STOPPING SIGHT DISTANCE**

**FIGURE 204.4A**

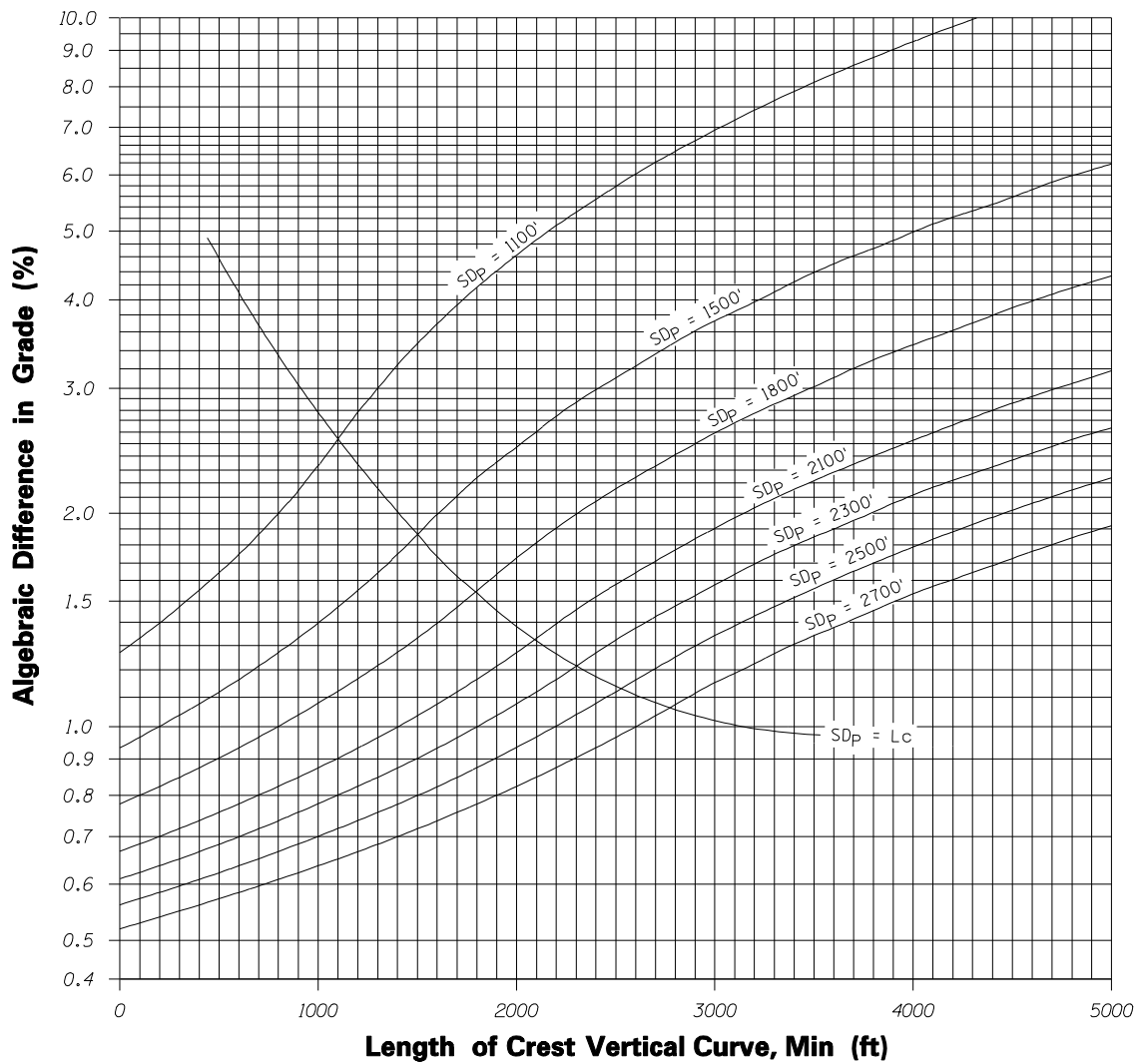

Where:  
 $SD_P$  = Passing Sight Distance, (ft)  
 $L_c$  = Length of Crest Vertical Curve Min, (ft)  
 $A$  = Algebraic Difference in Grade, (%)

For  $SD_P < L_c$      $L_c = \frac{A(SD_P)^2}{2800}$

For  $SD_P > L_c$      $L_c = 2(SD_P) - \frac{2800}{A}$

**RELATION OF MINIMUM LENGTH OF CREST VERTICAL CURVES TO PASSING SIGHT DISTANCE**

**FIGURE 204.4B**

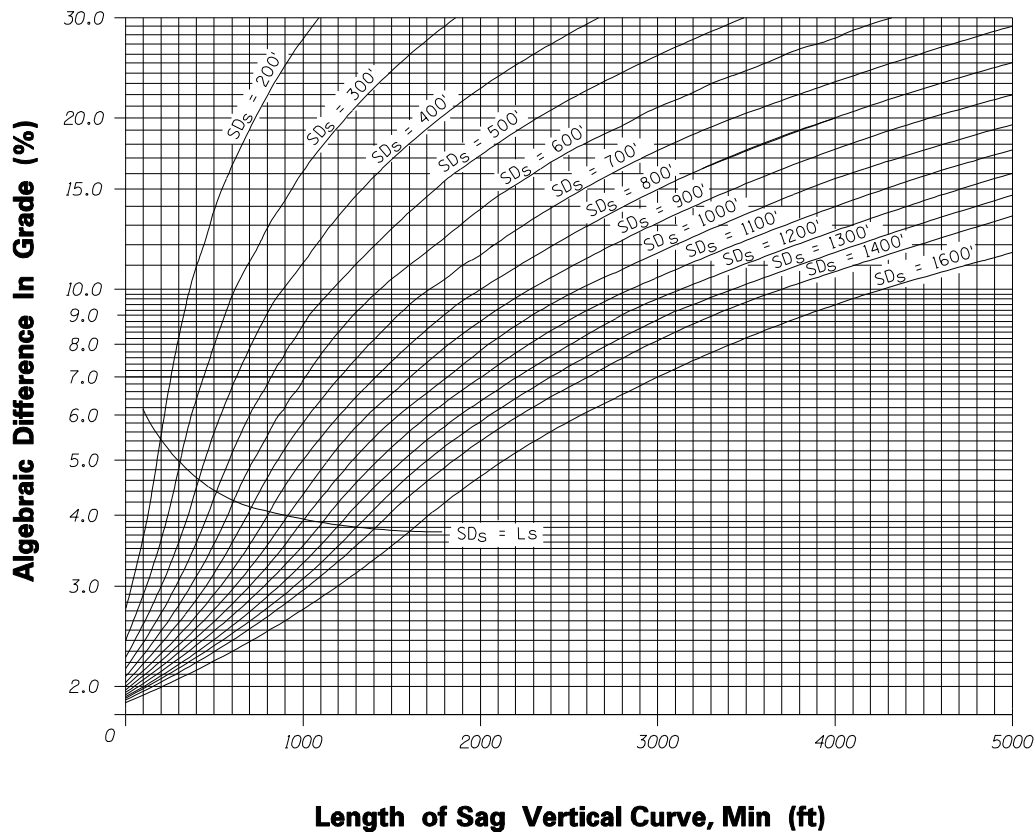

Where:  
 SD<sub>s</sub> = Stopping Sight Distance, (ft)  
 L<sub>c</sub> = Length of Sag Vertical Curve, Min (ft)  
 A = Algebraic Difference in Grade, (%)

For SD<sub>s</sub> < L<sub>c</sub>     $L_c = \frac{A(SD_s)^2}{400 + 3.5SD_s}$

For SD<sub>s</sub> > L<sub>c</sub>     $L_c = 2(SD_s) - \left( \frac{400 + 3.5SD_s}{A} \right)$

**RELATION OF MINIMUM LENGTH OF SAG VERTICAL CURVES TO STOPPING SIGHT DISTANCE**

**FIGURE 204.4C**

### **204.5 - Sustained Grades**

The maximum grade guideline is not sufficient to provide uniformity of operation. The length of an uphill grade must be included as an important design consideration because it affects operational speed, capacity, level of service, and delays when trucks, buses and recreational vehicles are present.

Generally, a truck speed reduction of up to 10 mph can be assumed to not significantly impact the capacity of a highway. Consideration should be given to providing additional lanes for any highway where the truck speed reduction due to length of grade is greater than 10 mph and there is a significant reduction in level of service when moving from the approach segment to the grade. On two-lane highways, a climbing lane should be considered when, in addition to the above criteria, the upgrade traffic flow is in excess of 200 vehicles per hour and the truck factor is more than ten percent. [Figure 204.5](#) shows the relationship between the reduction of truck operating speed to the length of upgrade for a typical heavy truck of 200 pounds per horsepower.

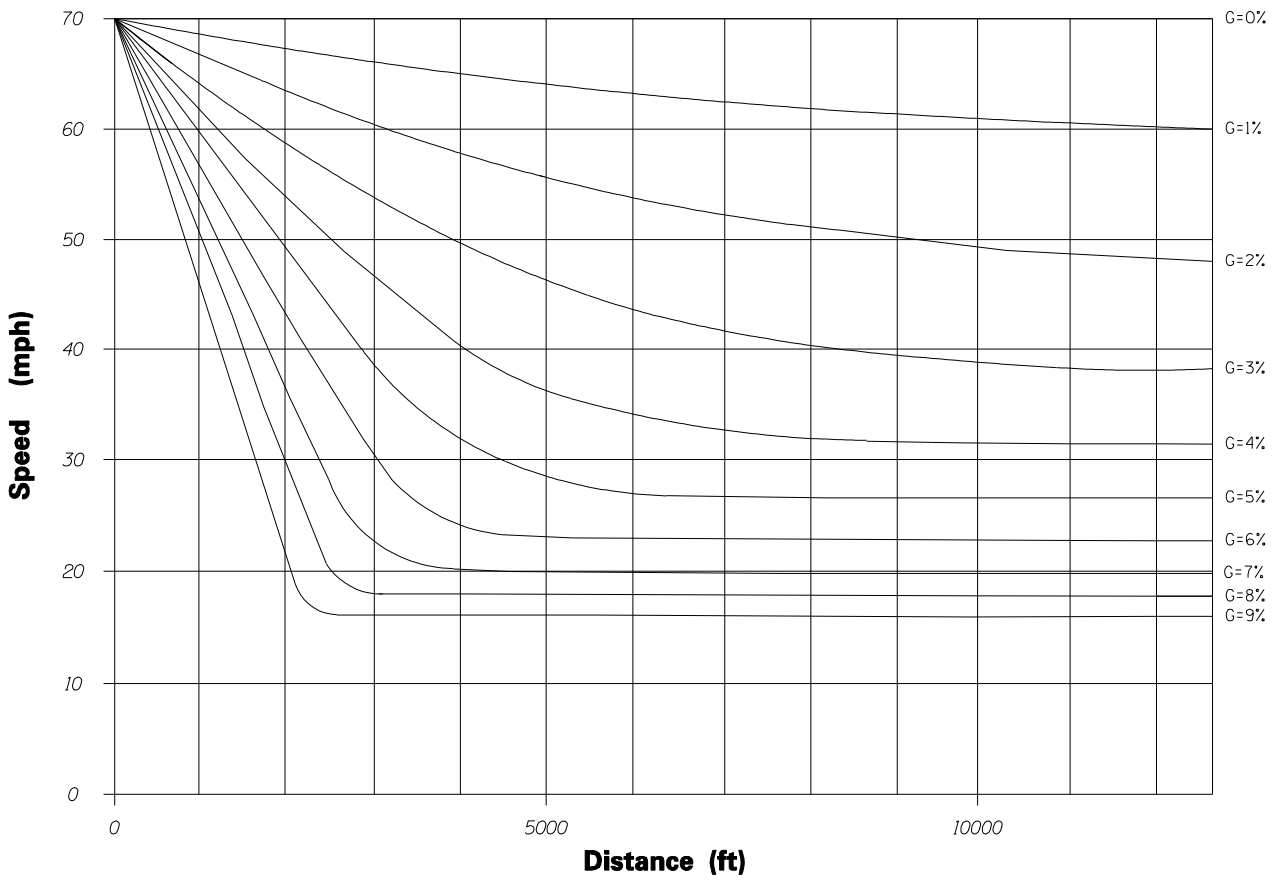

G = Grade of Roadway (%)

See AASHTO Exhibit 3-59

**RELATION OF REDUCTION OF TRUCK OPERATING SPEED TO LENGTH OF UPGRADE**

**FIGURE 204.5**

## **204.6 - Separate Grade Lines**

**Separate grade lines shall be used for all divided highways.**

The use of separate grade lines for divided highways provides the opportunity to optimize the design to better fit Arizona's terrain.

To avoid driver confusion and wrong-way movements, any appreciable grade differential between roadways should be avoided near at-grade intersections.

## **205 - Coordination of Vertical and Horizontal Alignments**

The importance of proper design of a highway cannot be stressed enough. Proper design will result in a highway that is safe, affords uniform operation, and is in harmony with its location. Proper design is primarily exhibited through the coordination of horizontal and vertical alignment to satisfy the constraints of the site and to conform to the values of the community.

Horizontal and vertical alignments are permanent design elements and thus warrant thorough study. Deficiencies in alignment are extremely difficult and costly to correct after the highway is constructed. On Interstate and controlled-access highways, the locations of bridges and retaining walls generally preclude any appreciable shifting of alignments; on urban highways, the narrowness of rights-of-way and the potential impacts on adjacent development constrain corrective adjustments to the alignments. The adage, "Get it right the first time!" is especially applicable to the design of horizontal and vertical alignments. There is seldom a time in the design of major highways when it is appropriate to substitute expediency for thorough analysis, "cook-book" for innovative design, and "good enough" for quality.

It is in the coordination of horizontal and vertical alignments that the skill of the highway designer comes through. The ability to visualize in three dimensions the integration of horizontal and vertical curvature; to conceptualize the reactions of the driver navigating the completed highway; and to mentally adjust these images to fit the location and provide a safe and pleasant driving experience are essential to the design process.

While the coordination of horizontal and vertical alignments is truly an art based on experience and engineering judgment, there are a few technical concepts which can be listed as guides.

These are:

- A) Avoid excessive curvature to obtain flat grades and tangent alignment or flat curves at the expense of steep or long grades. It is better to seek the middle ground than to provide horizontal and vertical alignments that are not in balance.
- B) Avoid sharp horizontal curvature at or near the top of a crest vertical curve. This condition makes it difficult for the driver to perceive the curve, especially at night when headlights continue on in a straight line and do not illuminate the curve.

- 
- C) Avoid sharp horizontal curvature at or near the low point of a sag vertical curve. Foreshortening of the horizontal curve and high approach speeds may result in erratic operation, especially at night.
  - D) Avoid successive changes in profile which are not associated with horizontal curves. The succession of humps is unattractive.
  - E) Horizontal curvature and profile should be as flat as possible at intersections where sight distance along both roadways is important and vehicles may have to slow, stop or start.
  - F) Divided highways afford an opportunity to achieve the operational and design advantages of one-way roadways. Median widths may be varied and independent roadway profiles established to better fit the terrain at little, if any, additional cost. (See [Section 204.6](#) above.)
  - G) On two-lane highways, the need for numerous, safe passing sections will sometimes supersede the general desirability of closely coordinating the horizontal and vertical alignments. In such instances, passing requirements may take precedence over other operational considerations. The designer should analyze the roadway for passing opportunities according to [Figure 204.4B](#). See [Section 209.2](#).
  - H) In general, the highway's alignments should be designed to take full advantage of scenic opportunities. Horizontal and vertical alignment should lead into outstanding views or features, not away from them. The designer should consult with Roadside Development Section regarding such opportunities.
  - I) Horizontal curves should lead into or be longer than the vertical curves upon which they are imposed.

Developing a competent design for horizontal and vertical alignments is necessarily an iterative process. The general horizontal and vertical design controls are examined separately and a conceptual graphical solution made for each. Then the combined solution can be analyzed from the aspects of terrain, traffic operation and appearance. The solutions are then refined and the process repeated until a superior design is achieved. As the solutions are refined, the analysis should go into greater detail including plotting of shoulder and gutter profile gradelines.

---

## **206 - Bridges and Grade Separation Structures**

### **206.1 - General**

A bridge is a structure, including supports, erected over a depression, obstruction, waterway, highway or railway, having a track or passageway for carrying traffic or other moving loads, and having an opening measured along its centerline of more than 20 ft between undercopings of abutments or spring lines of arches or extreme ends of openings for multiple boxes. It may include multiple pipes, where the clear distance between openings is less than half of the smaller contiguous opening. Bridges fall under the purview of the Bridge Group.

### **206.2 - Structure Identification**

Names of State bridges are assigned by the State Bridge Engineer in accordance with the kind of facility that goes under or over the principal route. A traffic interchange structure will have "T.I." as a part of the name. Overpasses (major highway passes over) carrying one-way traffic will also include the direction of traffic as part of the name. The name "bridge" is usually reserved for structures over watercourses or canyons.

### **206.3 - Profile Gradelines at Structures**

A) *General*: Most highway projects include some kind of structure for stream crossings, highway grade separations, or railroad grade separations. In most cases, these structures impose an additional constraint on the profile gradeline due to required clearances and structure depths. Final structure depths will be established by the Bridge Group. Early coordination with Bridge Group is essential, especially for complex or unusual bridge structures.

B) *Structure Depth*: The depth-to-span ratio for each structure is based upon span length, type of construction, aesthetics, cost of construction, falsework limitations and vertical clearance limitations. Refer to the Bridge Group for design guidance on depth-to-span ratios.

C) *Depressed Grade Line Under Structures*: Locating the low point of a depressed profile gradeline away from a structure will reduce conflicts between the structure foundations and any drainage structures.

#### **206.4 - Vertical Clearance to Structures**

The required minimum vertical clearances to structures on the highway system are provided in the [Bridge Group Design Guidelines, Section 2](#). Clearances are provided for highway traffic structures, pedestrian overpasses, tunnels, sign structures and railroad overpasses. **Lesser clearances shall be used only under very restrictive conditions and with the approval of the Assistant State Engineer, Roadway Engineering Group and the State Bridge Engineer.**

The minimum vertical clearance should be provided over the entire roadway width under the structure, including auxiliary lanes and shoulders. Consideration should be given to future widening of the roadway under the structure and also future widening of the structure to accommodate additional lanes, sidewalk, etc.

Vertical clearances over watercourses should be established by Bridge Group.

Vertical clearances over canals should be coordinated with the owner and the Bridge Group.

**206.5 – Falsework**

When a grade separation structure is constructed over a roadway open to traffic, the preferred method of construction is to route traffic around the construction site through a detour. When a detour is not practical, falsework openings must be provided. See [Section 316](#) for additional guidance on detour design.

Guidelines for falsework traffic openings and falsework dimensions are available in the ADOT on-line manual, [Bridge Group Design Guidelines, Section 16 - Bridge Construction](#).

### **207 - Pavement and Lane Transitions**

Pavement transitions occur when lanes are added or dropped such as at ramps and intersections, at detours and at changes in the number of lanes on a highway.

Pavement transitions should be consistent with the section having the higher design standards. The transition should be made on a tangent alignment section without horizontal and vertical sight distance restrictions. Desirably, the entire transition is visible to the driver approaching the narrower section. Intersections within the transition should be avoided. Drivers approaching the transition need to recognize and evaluate the situation and then decide on their course of action. The sight distance provided at pavement transitions should be significantly greater than the minimum stopping sight distance. Sight distances in the order of 1.5 to 2.0 times the minimum stopping sight distances would be appropriate for transitions on rural highways and urban controlled-access highways respectively.

- A) *Four-lane divided to two-lane:* The alignment of the transition from a four-lane highway to a two-lane section will be dependent upon the median width of the divided highway and upon the characteristics of the site. Whenever possible, the directional transition from two lanes to one lane should be accomplished on tangent alignment with the outside edge of the traveled way tapering at a rate of design speed (in mph) to one. A horizontal curve is normally used to transition back to the normal two-lane roadway. Where the median is narrow, an angle break of up to 45 minutes may be used.
- B) *Lane drops:* Dropping a lane by tapering should be accomplished at a taper rate of design speed (in mph) to one. The transition should occur on the right so that traffic merges to the left.
- C) *Lane additions:* The approach transition when adding passing lanes, climbing lanes or more through lanes may be made at a taper rate of 25 to 1 (e.g.- 12 ft lane = 300 ft taper).
- D) *Right turn, left turn, deceleration and acceleration lanes:* See [Chapter 400](#).
- E) *Shoulder transitions:* See [Chapter 300](#).

## **208 - Airports and Airways - Highway Clearances**

### **208.1 - General**

A) *Navigable Airspace*: It is the policy of ADOT to avoid any highway related obstruction of navigable airspace. An object is considered to be an obstruction to air navigation if any portion of that object is at a height greater than an imaginary surface extending outward and upward from the airport runway. Such objects include overhead signs, light standards, construction equipment, and moving vehicles on the highway and overpass structures.

B) *Construction or Alteration Requiring Notice*: The Federal Aviation Administration (FAA) has set forth regulations under the authority of 14 CFR Part 77 pursuant to 49 U.S.C. Section 44718. The regulations apply to any military airport or an airport/heliport that is available for public use and is listed in the Airport Directory of the current Airman's Information Manual or is under construction. Maps of the airports are available from ADOT Aeronautics Group. Each sponsor (ADOT) who proposes construction or alteration meeting certain specified requirements ("Part 77") shall notify the FAA, Western-Pacific Region in the form of a Notice. The requirements listed in the current edition of "Part 77" can be obtained from the ADOT Aeronautics Group.

C) *Notification Process*: The FAA, the local airport management, and ADOT Aeronautics Group must be notified when construction is planned near civil or military airports/heliports. A Notice of Proposed Construction or Alteration (FAA Form 7460-1) must be submitted to the FAA at the above address at least 30 days prior to the construction beginning date. The ADOT Aeronautics Group should be contacted if there is any question whether a Notice is required. The ADOT Aeronautics Group can provide the required forms. Copies of the completed Notice should be forwarded to ADOT Aeronautics Group and to the local airport affected by the proposed construction/alteration. Notice to the FAA, the local airport management and ADOT Aeronautics Group is the responsibility of the Predesign Section through the Project Manager.

D) *Design Process:*

*Pre-design Phase:* In order to provide a thorough evaluation of the potential impacts of ADOT construction on navigable airspace, project alignments and design features should be analyzed during the pre-design phase of project development. Determination of a need for Notice should be made during the pre-design phase of project development. ADOT Aeronautics Group should be notified during the pre-design reviews for new construction projects located within 4 miles of an airport facility. Official maps showing the existing military and public use airports/heliports are available from ADOT Aeronautics Group.

*Design Phase:* During the design phase, the designer must be aware that any revisions in horizontal or vertical alignment, as well as the final design location of highway features may impact navigable airways and must be re-evaluated. A Notice may be required during the design phase when one may not have been required during the pre-design phase. Consideration should be given to writing a special provision in the contract to advise contractors of the Notice and requirements for construction equipment operating in or near a navigable airspace.

## **209 - Auxiliary Lanes**

### **209.1 - Climbing Lanes**

Climbing lanes are most effective on uphill grades and curving alignment where the speed differential between vehicle classes is significant. In such cases, consideration should be given to providing right-of-way and grading for future climbing lanes on divided highways when the design year traffic is expected to be near capacity.

Generally, climbing lanes should be considered where the average directional hourly volume is over 200 vph, the truck (including recreational vehicles) ratio is 10 percent or more and where a 10 mph decrease in truck operating speed is expected based upon the data in [Section 204.5](#). On multi-lane highways, an additional criterion for consideration of climbing lanes would be a level of service of "E" or less. For additional information on truck operating characteristics and critical lengths of grade see AASHTO Green Book, Chapter 3.

For two-lane highways, and depending on traffic, climbing lanes should normally not be constructed on tangent sections where the length of tangent equals or exceeds the passing sight distance. Passing will occur at such locations without the additional lane. The required double-yellow stripe increases delay for opposing traffic by eliminating passing opportunities.

Climbing lanes should be introduced before the upgrade reduces the truck operating speed by 10 mph **provided the sight distance and other requirements of Section 207 can be met.** The climbing lane should terminate beyond the crest of the hill:

- ◆ *On controlled-access highways* a distance where a truck has reached a speed that is within 10 mph of normal vehicle operating speed; see AASHTO Exhibit 3-56.
- ◆ *On other highways* a distance of 200 ft.

In addition to the above, a normal lane-drop transition meeting the requirements of [Section 207](#) should be provided.

In general, intersections should be avoided within a climbing lane. If intersections cannot be avoided, intersection sight distance should be provided within the fully developed climbing lane section.

Also see the design memorandum entitled “A Policy on the Design of Passing Lanes and Climbing Lanes” on the Roadway Design website. If bicyclists are utilizing the facility, a minimum shoulder width of 4 ft should be provided.

The Assistant State Engineer, Roadway Engineering Group or designee approves the use of climbing lanes by his/ her signature on the final scoping document.

## 209.2 - Passing Lanes

In rolling and mountainous terrain, passing sight distance may be difficult to provide economically over a significant portion of the highway. Vertical and horizontal curves meeting the requirements of passing sight distance are often more costly than those only meeting stopping sight distance requirements. Passing lanes may be the economical solution to providing passing opportunities on such highways.

Passing lanes should be considered on two-lane highways where passing sight distance cannot be provided at frequent intervals and where passing opportunities are negated by traffic volumes in the opposing direction. As with climbing lanes, a consideration to be weighed when implementing a passing lane on a two-lane highway is that Arizona practice (Traffic Engineering PGP) restricts passing in the opposing lane of traffic. As a minimum, passing opportunities should be provided at intervals of 3 to 5 miles. At distances greater than these, drivers will tend to tire of following slow moving vehicles and may take inappropriate risks to pass.

Generally, passing lanes are provided alternately in the opposing directions (a three-lane section). Under special conditions, a four-lane (two directional) passing section may be provided. In selecting either the three or four-lane section, consideration should be given to traffic volumes, construction costs, and the frequency of passing opportunities provided.

Depending upon terrain and other constraints, the length of passing lanes should allow several vehicles in line behind a slow-moving vehicle to pass before reaching the transition to the normal section. In any case, passing lanes should not be longer than 2 miles and not be shorter than 1300 ft.

Passing lane shoulder widths should meet the widths established for the new mainline roadway.

Care should be taken to avoid intersections within the passing lane zone. If an intersection cannot be avoided, intersection sight distance should be provided within the fully developed passing lane section.

The beginning and end of passing lanes should meet the criteria for adding and dropping lanes as provided in [Section 207](#).

For adding passing lanes to existing roadways, see the design memorandum entitled "[A Policy on the Design of Passing Lanes and Climbing Lanes](#)" on the Roadway Design website. If bicyclists are utilizing the facility, a minimum shoulder width of 4 ft should be provided.

The Assistant State Engineer, Roadway Engineering Group approves the use of passing lanes by his/ her signature on the final scoping document.

### **209.3 - Weaving Lanes**

Auxiliary lanes are sometimes added to controlled-access highways between the entrance and exit ramps of adjacent interchanges to facilitate the weaving movement of vehicles entering and exiting the highway. The need for these weaving lanes is determined by an analysis of the capacity of the highway section between the interchanges. See also the Valley Transportation Group "Interim Auxiliary Lane Guidelines".

### **209.4 - Truck Escape Ramps**

The combination of heavy trucks and steep highway downgrades presents a potential safety hazard to road users and occupants of roadside properties. On severe grades, the brakes plus the retarding power of the engine are sometimes insufficient to hold vehicles in check. Defective or incorrectly adjusted braking systems on trucks or trailer, among other things, can contribute to brake overheating and failure resulting in the driver's inability to control vehicle speeds on downgrades.

Truck escape ramps offer an opportunity for out-of-control trucks to exit the highway and come to a controlled stop.

There are two primary types of escape ramps: gravel arrester beds and gravity ramps. Arrester beds use open graded moderate diameter pea gravel in increasing depths to provide the rolling resistance necessary to bring the truck to a stop. With gravity ramps, trucks go up an incline until gravity forces bring them to a halt.

The primary indicator of a runaway vehicle problem is the number of accidents that occur in conjunction with a long sustained downgrade, usually at a horizontal curve. A secondary indicator of the need for a truck escape ramp is the number of vehicles with hot and/or smoking brakes. Information on the need for a truck escape ramp can be obtained from professional truck drivers, wrecker operators, Department of Public Safety officers, and by inspection of accident records.

Although there are no universally accepted criteria for determining the need for truck escape ramps, NCHRP Report No. 178, "Synthesis of Highway Practice for Truck Escape Ramps", offers approaches to need assessment and facility design. Logic indicates that escape ramps be considered where there is a combination of heavy trucks and long, steep downgrades leading into sharp curves or stop conditions. The graph shown in [Figure 209.4A](#) may be used as a guide for assessing the need for a truck ramp on new highways with downgrades extending several miles. The need for truck escape ramps and determination of their location is also influenced by the relationship of attainable runaway speeds and the highway design speed as well as adjacent terrain and construction cost considerations.

**The use of truck escape ramps shall have the approval of the Assistant State Engineer, Roadway Engineering Group and the Assistant State Engineer, Traffic Engineering Group.**

As an interim measure while the need for a truck escape ramp is being assessed, brake check areas should be provided at the summit of the downgrade. Providing an opportunity for operators to check their braking system and to obtain information regarding the alignment of the downgrade may eliminate the need for an escape ramp.

There are indications that escape ramps should only be considered on the lower half of a grade because this is where the need becomes most apparent to the driver of the runaway truck and they would then be more willing to use the ramp. Further, experience shows that ramps located between 3 to 4.5 miles from the summit of the grade intercept 70 to 80 percent of the out-of-control vehicles. More than one escape ramp may be required on very long, steep downgrades.

Escape ramps should not be located on curves. Negotiating the curve may be difficult for the driver and a tangent ramp off a curve may appear as the through roadway under some conditions. Ramps should be built in advance of curves that cannot be negotiated by an out-of-control truck.

Truck escape ramps should have a high-speed exit from the highway. Where conditions permit, the gravity ramp is preferred because of its construction and maintenance cost advantages--Arizona does not have a ready supply of the rounded gravel size that is best suited for the gravel arrester bed. Further, truck operators tend to be more accepting of the gravity ramps because they can visualize the truck coming to a halt; truck recovery costs are less with the gravity ramp.

The use of auxiliary lane exit ramp design should be considered if conditions allow. An auxiliary lane provides the opportunity for a runaway vehicle to travel outside the through traffic lanes for a distance prior to the arrester bed.

Roadside runoff should be channeled away from the escape ramp. Roadway drainage should not be allowed to flow into a gravel arrester bed, especially where sand or cinders are used for ice or snow control. For the gravel arrester bed, it may be necessary to provide some protection between the arrester bed and the service road. It is essential that water entering an arrester bed be drained away as rapidly as possible through the use of French drains, perforated pipes, slotted drains and proper grading of the prepared base.

The length of the escape ramp may be determined by the formula:

$$L = \frac{V^2}{30(R \pm G)}$$

AASHTO EQ 3-41

Where:

- $L$  = distance to stop in ft (arrester bed length);
- $V$  = entering speed in miles per hour, **(90 mph minimum, lower values require the approval of the State Traffic Engineer)**
- $G$  = percent of grade divided by 100;
- $R$  = coefficient of rolling resistance, 0.25 for pea gravel (see [Table 209.4](#) for values for other surfacing materials).

Where the grade may change within the bed, the final velocity at the end of the first grade may be calculated and used as the initial velocity ( $V_i$ ) for the next section, and so on. The same formula is used:

$$V^2 = V_i^2 - 510(R \pm G)$$

AASHTO EQ 3-42

where factors are as defined above.

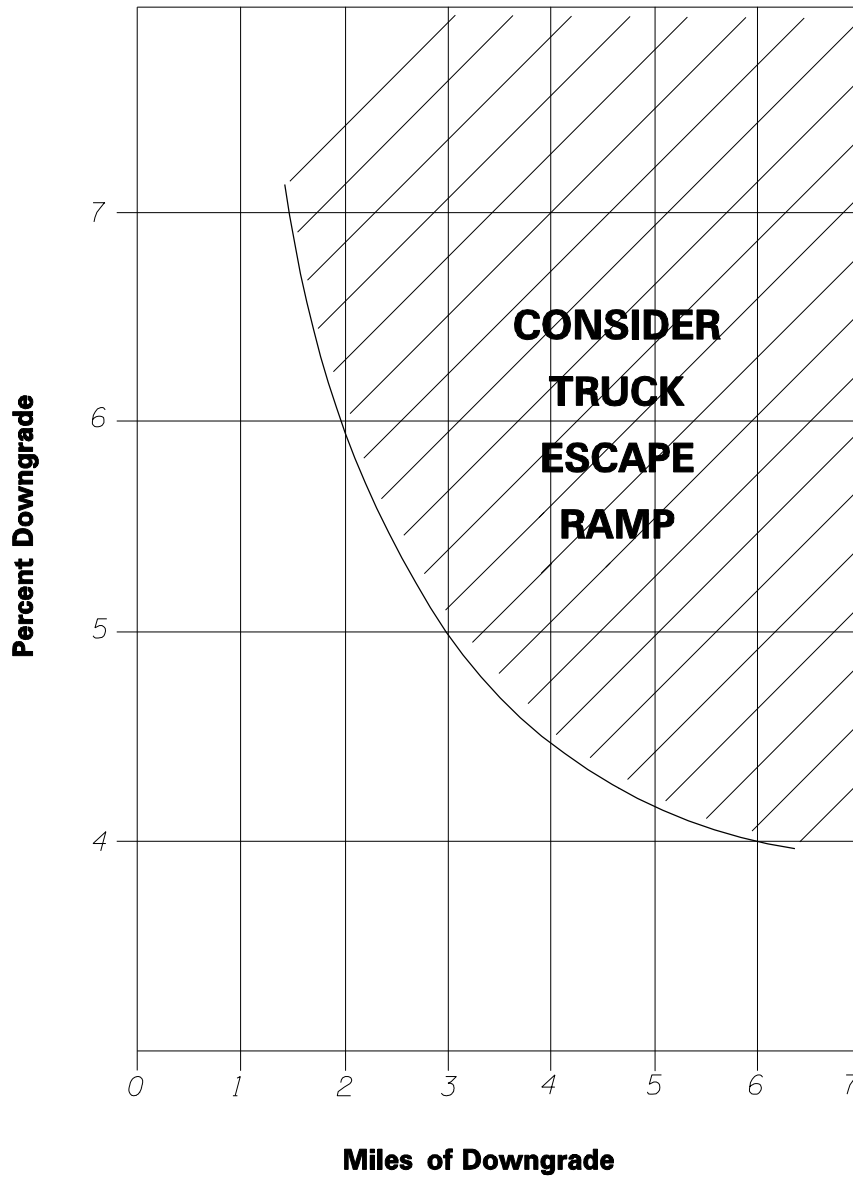

**CONSIDERATION OF TRUCK RAMPS  
VERSUS  
LENGTH & PERCENT OF DOWNGRADE**

**FIGURE 209.4A**

Both the pea gravel arrester bed and the gravity escape ramps should have service lanes adjacent to and along the length of the truck arresting area for the use of tow trucks and ADOT maintenance vehicles. Anchors for tow trucks should be spaced along the service lane at intervals of about 150 ft.

A gradual deceleration of a runaway truck is desirable to prevent jack-knifing or shifting of loads. Therefore, the depth of a gravel arrester bed should be linearly increased from 6 inches at the beginning to the maximum depth of 48 inches in the initial 150 ft.

A typical layout for a gravel arrester bed escape ramp is shown in [Figure 209.4B](#).

Mounds and barrels should be used only where needed ramp length cannot be provided. Vehicles should be slowed to 25 mph or less before reaching impact with them.

Brake check areas should be provided at the summits of grades with escape ramps. Information regarding the downgrade, its horizontal alignment and the location of the escape ramp should be displayed at the brake check area.

Typical signing and striping layouts for truck escape ramps and brake check areas are shown in Traffic Standard Drawings.

**Table 209.4**

**Values of Rolling Resistance "R"  
for Different Materials**

| Surfacing Material       | "R" Value |
|--------------------------|-----------|
| Portland cement concrete | 0.010     |
| Asphalt concrete         | 0.012     |
| Gravel compacted         | 0.015     |
| Earth, sandy, loose      | 0.037     |
| Crushed aggregate, loose | 0.050     |
| Gravel, loose            | 0.100     |
| Sand                     | 0.150     |
| Pea gravel               | 0.250     |

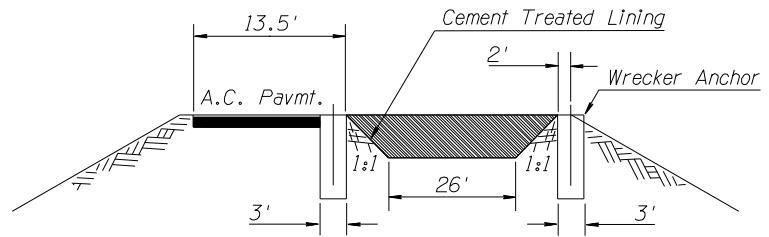
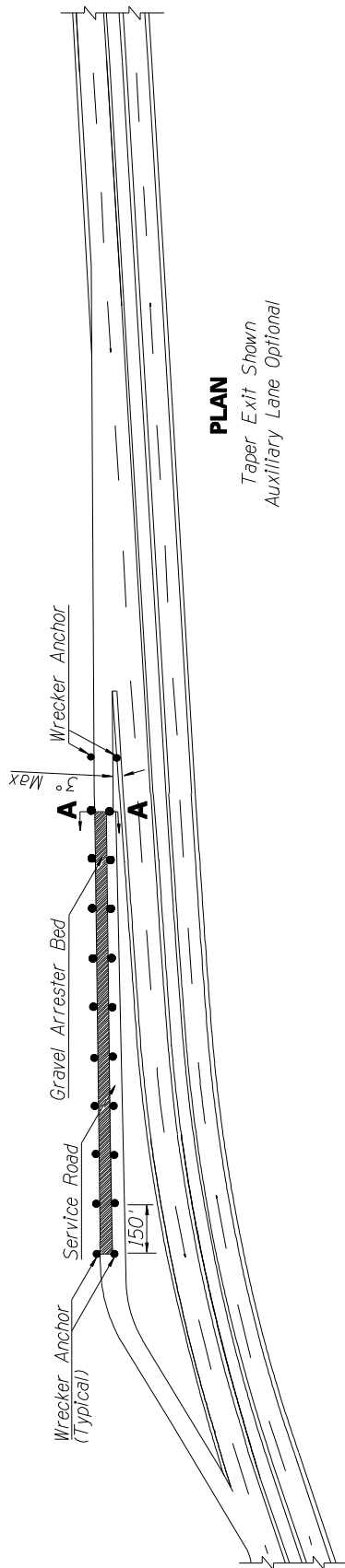

**SECTION A-A**

**TYPICAL LAYOUT  
TRUCK ESCAPE RAMP**

**FIGURE 209.4B**



## CHAPTER 300

### CROSS SECTION ELEMENTS

#### 301 - Pavement

##### **301.1 - Pavement Type**

The type of pavement will be established by the Materials Group based on the volumes and types of traffic projected for the facility, the project environment and the expected soil conditions.

In general, fringe/urban and urban freeways may be expected to have Portland cement concrete pavements (PCCP). As a noise reduction measure in residential and other sensitive noise areas, PCCP may be overlaid with a thin asphalt rubber overlay. Other State highways will generally have asphaltic concrete pavements. Each of these pavement types have the ability to retain adequate skid resistance, adequate drainage, and proper cross slope.

##### **301.2 - Cross Slope**

Undivided highways with two or more lanes in a normal tangent section should have a crown high point at the centerline of the pavement and the pavement sloped downward toward the edges on a uniform grade.

Divided highways in a normal tangent should have a high point for each roadway at the median edge of the roadway and each pavement sloped downward toward the outside edge. Generally, the entire width of each roadway pavement will have a uniform cross slope.

**The standard cross slope for all types of paved surfaces shall be 0.02 ft/ft. On unpaved roadway surfaces, it should be 0.03 ft/ft.**

**The maximum algebraic difference in cross slope between adjacent opposite direction lanes for facilities constructed on a crown section shall be 4%. The maximum algebraic difference in cross slope between adjacent same-direction general traffic lanes shall be 1% except where necessary to crown cross slope for drainage purposes; the maximum breakover shall be 4%.**

**The maximum difference in cross slope between the traveled way and the adjacent shoulder shall be 4 %.**

In adding new lanes to existing roadways, the cross slopes of the new lanes should be 0.02 ft/ft in tangent sections.

### **301.3 - Lane Width and Pavement Width**

The width of all traffic lanes including through lanes, auxiliary lanes between interchanges, HOV lanes, ramp and frontage road lanes, left-turn and right-turn lanes shall be 12 ft except at urban intersections where right-of-way restrictions and existing roadway conditions govern. At such intersections, through lane widths may be reduced to 11 ft and left-turn lanes may be as narrow as 10 ft if necessary. In curb and gutter sections on the right side of traffic, a 12 ft lane with a minimum 2 ft paved shoulder, exclusive of the curb and gutter, shall be provided.

The pavement width shall provide for the number of traffic lanes required by the projected traffic volumes plus the appropriate minimum paved shoulder widths given in [Table 302.4](#). Pavement widths shall be sufficient to accommodate bicycle traffic in accordance with the ADOT Bicycle Policy.

### **301.4 - Pavement Details**

Care should be given in the geometric layout design of pavement to avoid introducing expensive and difficult to construct details. To the fullest extent possible, pavement should have a constant width to facilitate the use of paving machines and to minimize handwork, especially with Portland cement concrete pavement (PCCP).

Recommended Portland cement concrete pavement construction joint locations and details are shown in the ADOT Construction Standard Drawings (C-Stds). Plan details should supplement the C-Stds. when necessary.

In general, vertical joints between new and existing asphaltic concrete pavement should be butt joints for all paving course thicknesses - including asphaltic concrete friction courses (ACFC). Accomplishing vertical tapering by feathering of asphaltic concrete is not acceptable.

On asphaltic concrete pavements, the total structural section thickness given in the Materials Design Report and as shown in the project plans normally includes a 1/2 in. ACFC. The ACFC is above the profile grade elevation and is not included in the calculation for the shoulder wedge dimension discussed in [Section 303.3](#).

## **302 - Shoulders**

### **302.1 - Shoulder Structural Section**

The shoulder structural section, including pavement type, will be established by the Materials Group. Unless otherwise shown in the Materials Design Report, the shoulder area outside the pavement width will be as shown for the appropriate condition in [Figures 302.1](#) and [303.1](#).

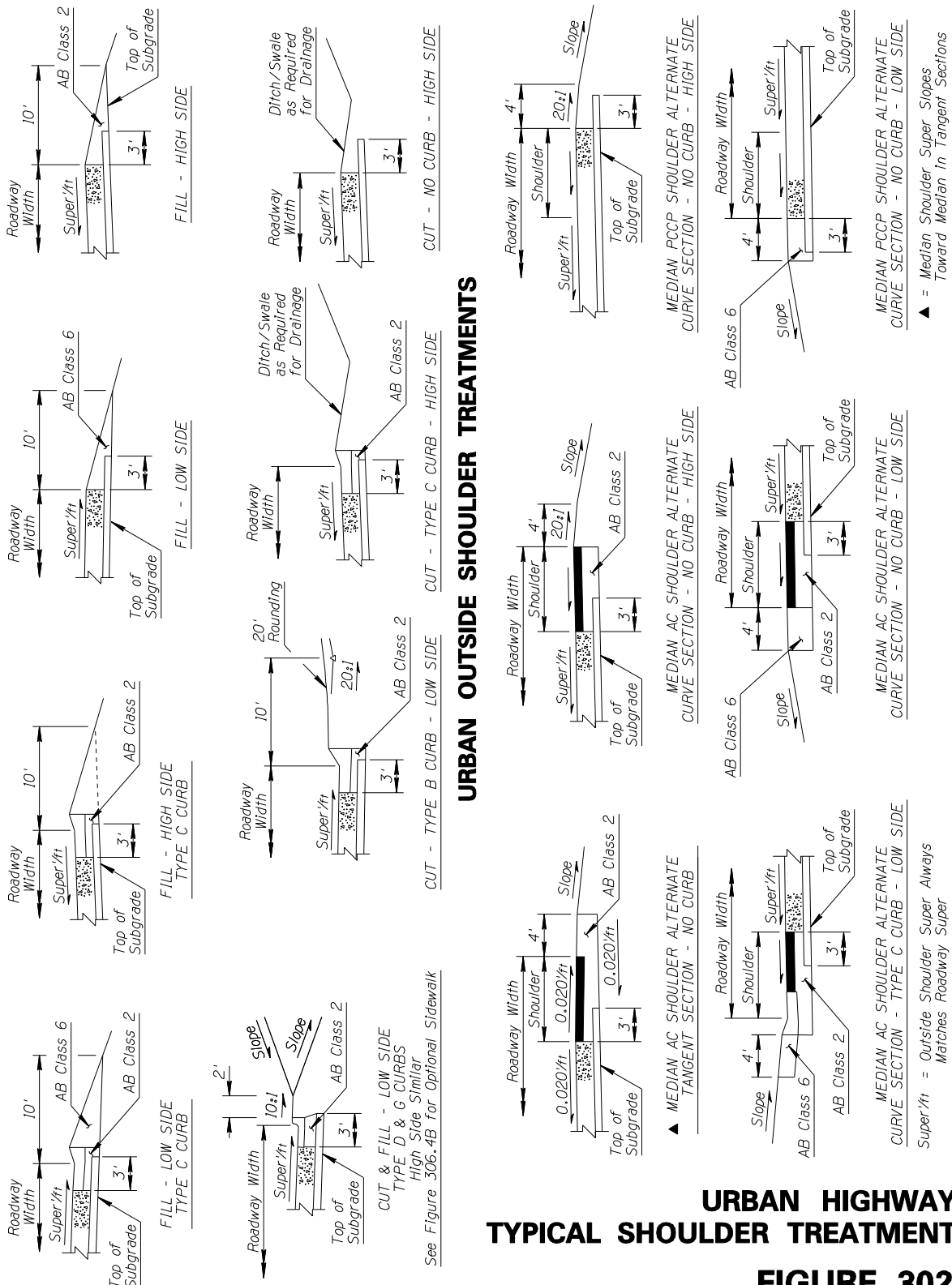

**URBAN OUTSIDE SHOULDER TREATMENTS**

**URBAN HIGHWAYS  
 TYPICAL SHOULDER TREATMENTS  
 FIGURE 302.1**

**URBAN MEDIAN SHOULDER TREATMENTS**

### 302.2 – Shoulder Curbs (Standard C-05.10)

In general, the outside shoulders of rural highways will not have curbs except where embankment curbs may be provided as required to control drainage and prevent slope erosion. For urban streets and highways, curb and gutter is commonly used and sloping freeway curbs are used on controlled access highways to control drainage and prevent slope erosion. The following is a discussion on the various types of curbs in the Construction Standard Drawings.

Sloping Freeway Curb and Gutter Types B, C, C-1, E and E-1 are used where needed on mainline and ramp shoulders to control drainage and/or to prevent erosion. In general, Type B Freeway Curb and Gutter is used on the low side shoulder where mainline or ramps are depressed. Type C curbs are used elsewhere. Refer to [Figures 302.2A-D](#) for Urban Freeway Curb and Gutter applications. Transitions between Type B and Type C curbs should be made at suitable locations to accommodate drainage and constructability. More specific guidance is as follows:

**Type B Curb h=6", 3:1 Curb Slope-** Type B Curb and Gutter should be used on the low side outside shoulder of depressed urban controlled access highways, specifically mainline roadways and ramps, with 3:1 cut slopes. See [Figures 302.2A-B](#). Ramps with superelevation sloping toward the mainline should use Type B Curb and Gutter on the inside shoulder if the mainline roadway is above the ramp and the runoff between the mainline and ramp is picked up at the ramp gutter. See [Figure 302.2D](#).

**Type C Curb h=3", 6:1 Curb Slope-** Type C or C-1 Curb and Gutter should be provided on the mainline outside shoulders and on the shoulders of elevated and depressed ramps unless Type B curb is warranted as discussed above. Type C-1 Curb and Gutter should be used on the high side outside shoulder in depressed mainline and ramp applications. A ditch should be provided behind the high side curb to contain runoff from the 3:1 backslope. See [Figures 302.2A-D](#). With very shallow 3:1 cut slopes, the Type C or C-1 curb should be utilized.

On embankments for urban controlled access highways, Type C or C-1 Curb and Gutter may be utilized for erosion control, drainage, or continuity. For mainline applications, Type C Curb and Gutter should be used to control erosion when the following conditions are present: outside slopes steeper than 6:1 or superelevation greater than standard cross slope to the outside. Median side curb and gutter, when provided for drainage interception, should be Type C.

**Type E Curb h= 4", 6:1 Curb Slope-** Type E and E-1 Curb and Gutter should be used in lieu of Type C and C-1 Curb and Gutter when a 1" asphaltic overlay of the PCCP is provided for quiet pavement treatment and to maintain a 3" curb height for drainage. Use as described in the forgoing discussion on Type C curb.

**Types A and D Series Curbs and Curb and Gutter** are used on the outside of non-controlled access urban highways where typically, sidewalks are provided or planned in the future. Gutter width will be as required for drainage.

**Type G** single curb or curb and gutter with a 3" radius is more easily mountable and may be specified in areas where maintenance forces need occasional access but do not wish to invite off-road use by constructing a depressed curb. It can also be utilized for other special locations depending upon the application.

Other mountable type "rolled" curbs having larger radii and heights of 3" or 4" can be provided using special details. Special applications would include areas such as truck aprons in roundabouts and other separators where large vehicles may occasionally pass over and be unobstructed by vertical curbing.

The project plans should detail where aggregate base is to be placed under curb and gutter when warranted by local soil conditions.

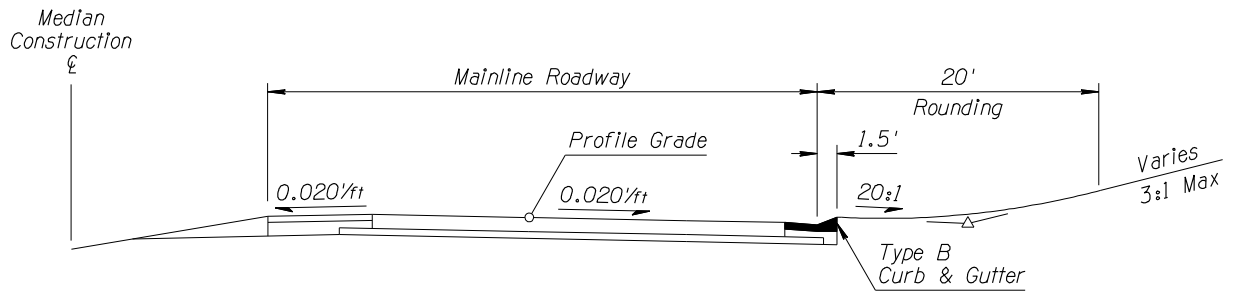

MAINLINE DEPRESSED - TANGENT SECTION  
Right Roadway Shown

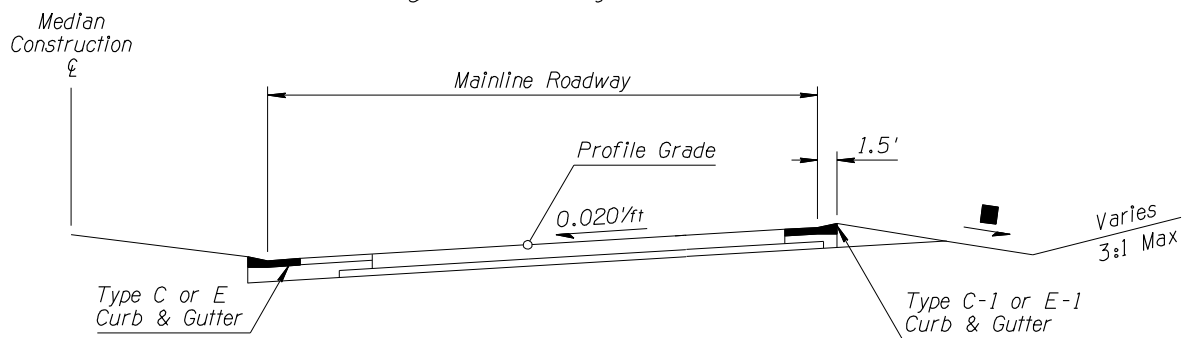

MAINLINE DEPRESSED - CURVED SECTION  
Right Roadway Shown

■ Ditch Width and Slope  
As Required to Intercept  
Drainage

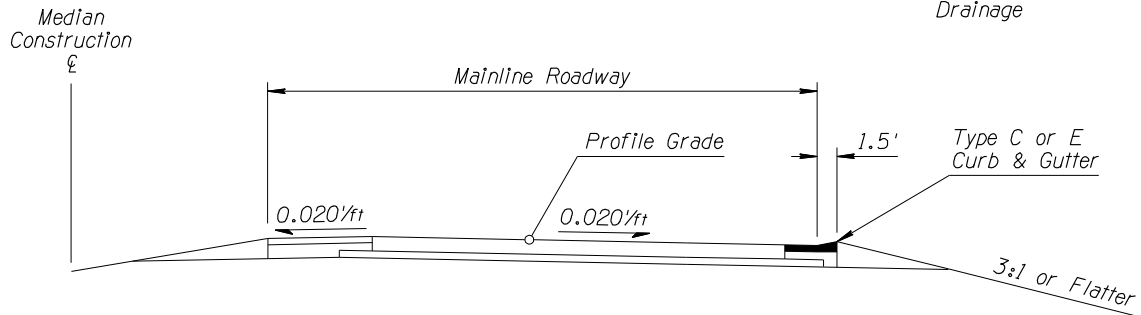

MAINLINE ELEVATED and AT-GRADE - TANGENT SECTION  
Right Roadway Shown

|   |
|---|
| TYPE B FREEWAY CURB & GUTTER h=6" / 3:1 CURB SLOPE              |
| TYPES C & C-1 FREEWAY CURB & GUTTER H=3" / 6:1 CURB SLOPE       |
| TYPE C-1 (High Side)(Gutter Slope Matches Pavement Cross Slope) |
| TYPES E & E-1 FREEWAY CURB & GUTTER H=4" / 6:1 CURB SLOPE       |
| TYPE E-1 (High Side)(Gutter Slope Matches Pavement Cross Slope) |

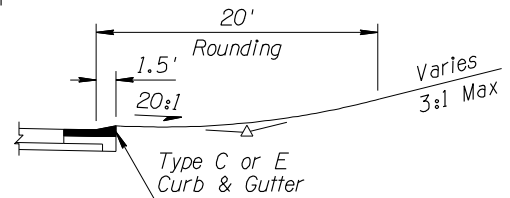

LOW HEIGHT CUT CONDITIONS  
SEE SECTION 302.2

**URBAN FREEWAY CURB & GUTTER GUIDELINES**

**FIGURE 302.2A**

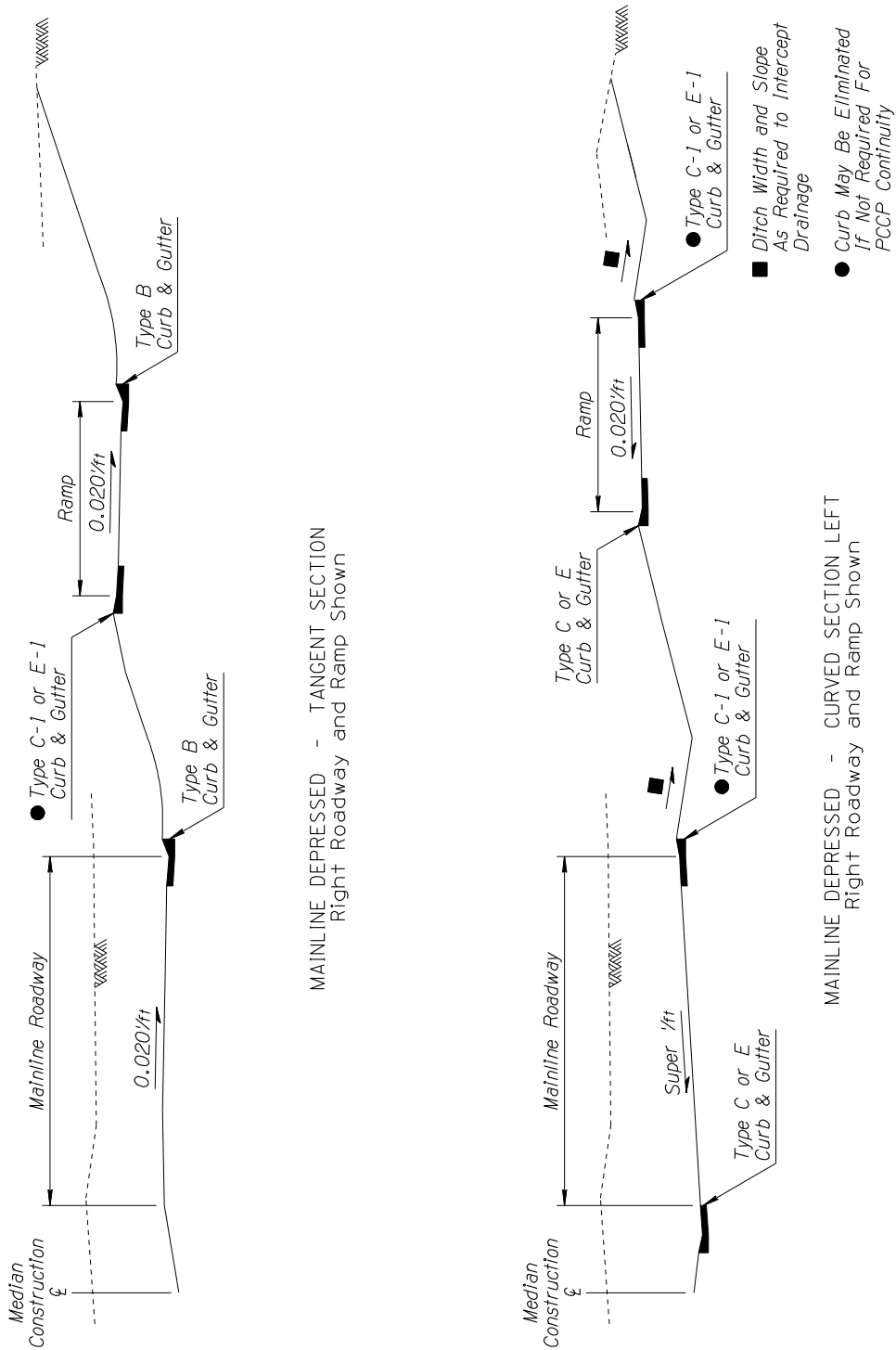

**URBAN FREEWAY CURB & GUTTER GUIDELINES**  
**FIGURE 302.2B**

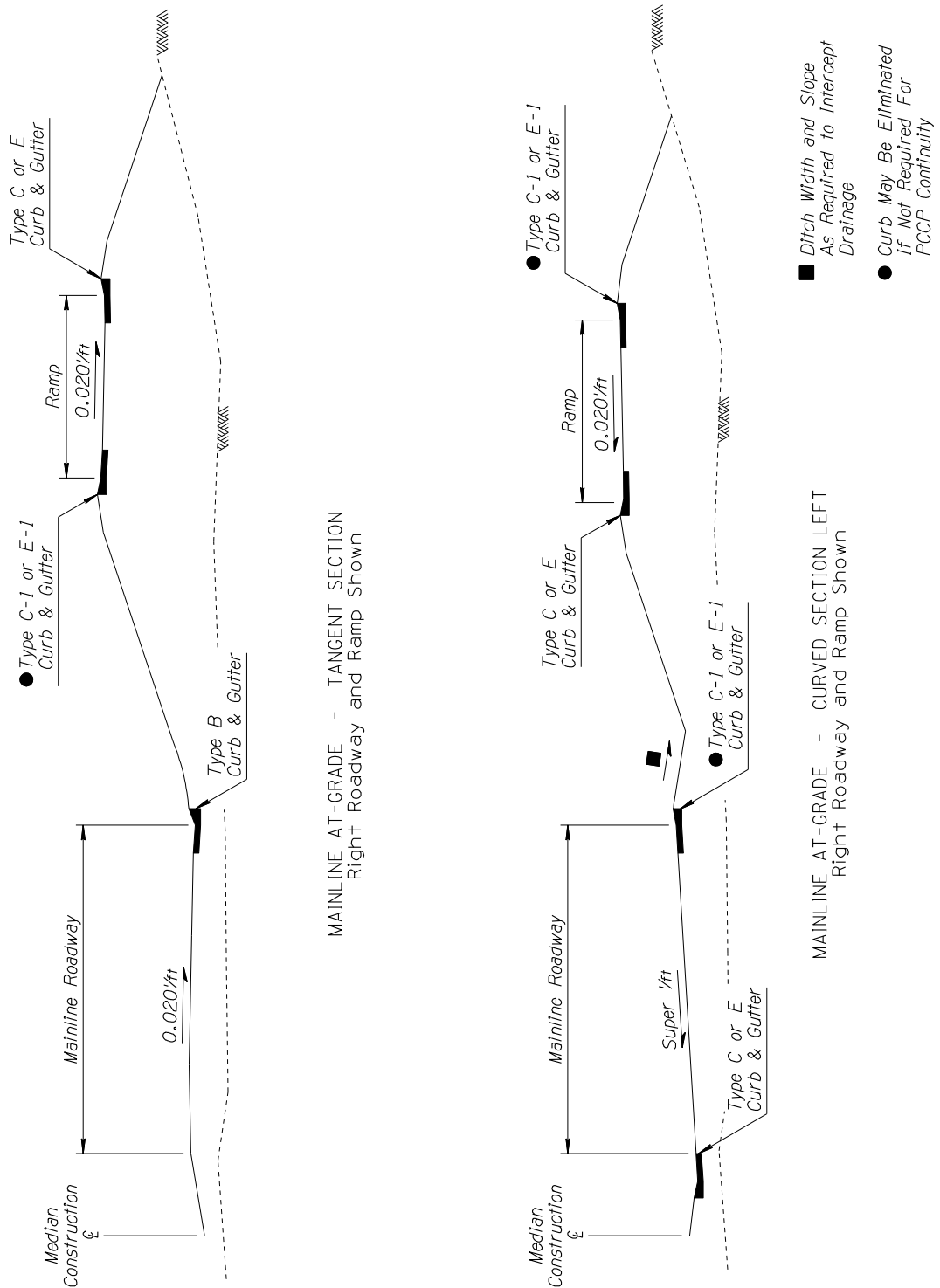

**URBAN FREEWAY CURB & GUTTER GUIDELINES**  
**FIGURE 302.2C**

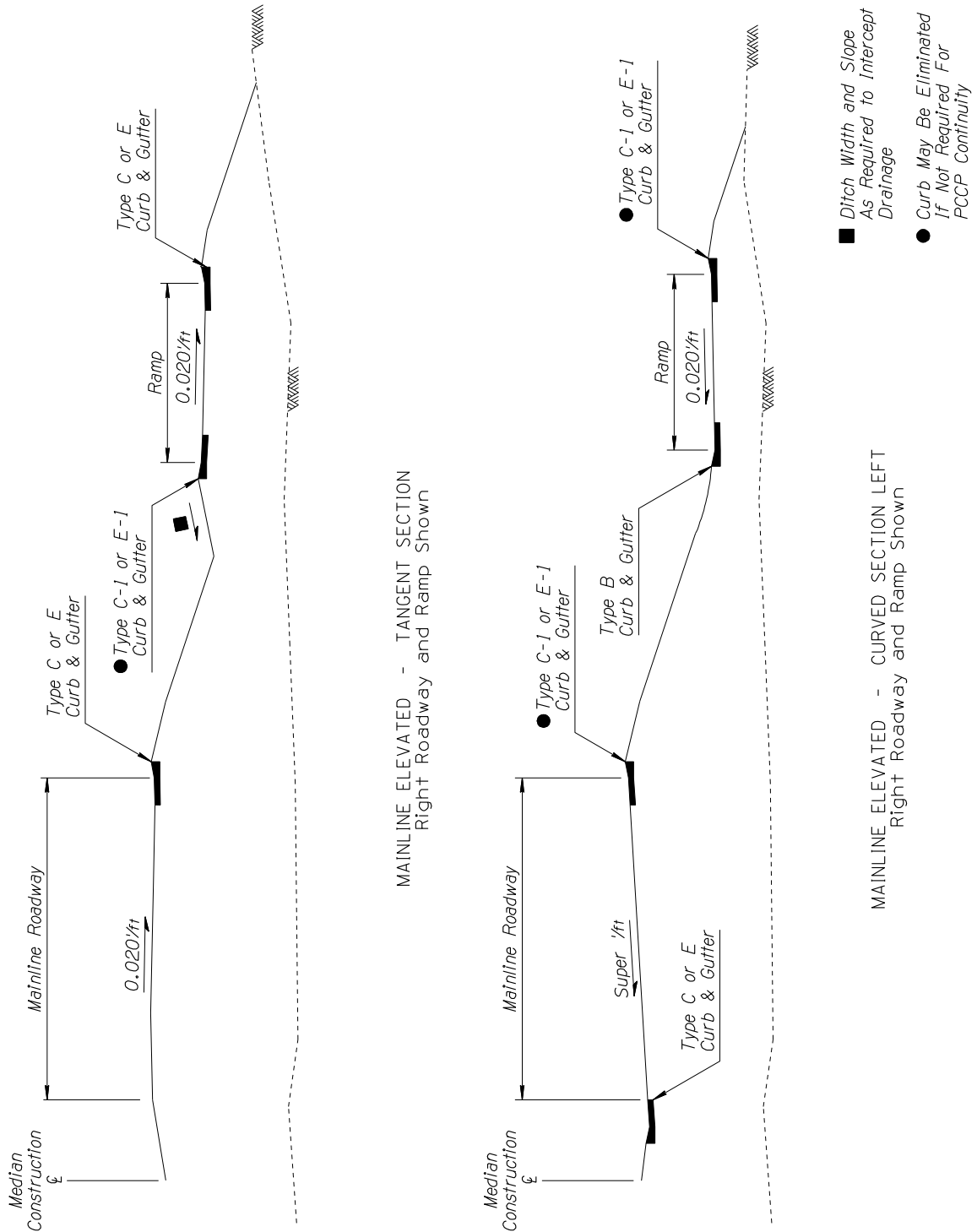

**URBAN FREEWAY CURB & GUTTER GUIDELINES**  
**FIGURE 302.2D**

### **302.3 - Continuous Longitudinal Rumble Strips**

Continuous longitudinal rumble strips will normally be applied to new construction when the thickness of the asphaltic concrete shoulder will allow placement in accordance with the Traffic Engineering Group Policy entitled "Continuous Longitudinal Rumble Strips".

Shoulder width placement criteria is contained in the Policy. Details of the rumble strip application are maintained by Traffic Engineering and will be included as applicable in the plans traffic sheets.

In general, rumble strips are applied on the shoulders of rural highway sections and should not be applied in urban, developed, or developing areas. In suburban areas, a determination will be made for each project through coordination with Traffic Engineering and the District on whether rumble strips are appropriate.

Traffic Engineering Group also implements rumble strip projects on existing highway sections to reduce the potential for single-vehicles, run-off-road crashes.

### 302.4 – Shoulder Width

The shoulder width given in Table 302.4 shall be the minimum continuous usable width of paved shoulder.

| <b>Table 302.4</b>  |  |                 |
|---|--|-----------------|
| <b>Paved Shoulder Width</b>   |  |                 |
| <b>Highway Type</b>   | <b>Paved Shoulder Width<sup>2</sup> (ft)</b><br>(In Direction of Travel) |                 |
|   | <b>Left</b>  | <b>Right</b>    |
| <b>Controlled-access Highways</b>   |  |                 |
| 4 lanes   | 4  | 10              |
| 6 or more lanes   | 10 <sup>1</sup> ,  | 10 <sup>1</sup> |
| Auxiliary lanes   | --   | 10              |
| 1-lane freeway to freeway directional ramp                                  | 6  | 10              |
| 2-lane freeway to freeway directional ramp                                  | 4  | 8               |
| 1-lane and 2-lane ramps   | 2  | 8 <sup>3</sup>  |
| Ramp Termini at Crossroad   | 2  | 2               |
| <b>Non-Controlled-access Highways</b>                                       |  |                 |
| Rural multi-lane divided  | 4  | 10              |
| Rural 2-lane:   |  |                 |
| DHV > 200 vph   | --   | 8               |
| DHV < 200 vph   | --   | 6               |
| Fringe-urban multi-lane divided:  |  |                 |
| w/ curbed median  | 4  | 8               |
| w/o curbed median   | 4  | 10              |
| Fringe-urban multi-lane undivided   | --   | 8               |
| Urban multi-lane divided  | 2  | 4               |
| Urban multi-lane undivided:   |  |                 |
| 5 or more lanes   | --   | 4               |
| 4 lanes   | --   | 4               |
| Right-turn lanes (without curb and gutter)                                  | --   | 4               |
| Acceleration lanes  | --   | 4               |
| Frontage Roads (2-lane)   |  |                 |
| One-way   | 2  | 4               |
| Two-way   | --   | 4               |
| Passing Lanes/Climbing Lanes  | See <a href="#">Sections 209.1</a> & <a href="#">209.2</a>               |                 |
| <sup>1</sup> 12 ft desirable with truck traffic DDHV > 250                  |  |                 |
| <sup>2</sup> For shoulders with curb and gutter, widths include gutter pan. |  |                 |
| <sup>3</sup> Use 2 ft for two-lane dual metered ramps.                      |  |                 |

### **302.5 - Shoulder Width Tapers**

With widening and reconstruction projects, new shoulder widths are commonly employed, necessitating tapers in shoulder widths to the existing adjacent roadway sections. The following guideline for taper rates can be utilized: in the direction of traffic, taper rates from narrow to wider shoulder width can be adequately implemented with a taper rate of approximately 15:1. When tapering from wider to narrower shoulder width, the desirable rate is design speed:1 however shorter tapers can be used to meet existing conditions.

When the shoulder width tapers within a project such as at the approach to a narrow structure, the taper rate for the shoulder should follow the taper rate established for the approach barrier.

### **302.6 - Shoulder Slopes**

On a normal tangent section, shoulders to the right of traffic should have the same slope as the adjacent traffic lane.

For divided roadways, the shoulder to the left of traffic should slope at the same slope as the adjacent traffic lane except for urban divided freeways the left shoulder slopes toward the median for the interim facility. See [Figure 306.4B](#).

See [Section 202.3](#) for the treatment of shoulder slopes in superelevated curves.

## **303 - Side Slopes**

### **303.1 - General**

See [Figure 303.1](#) for side slope nomenclature. Also see the interchange ramp side slopes in [Section 504.4](#).

The design of side slopes should consider the specific recommendations of the project Materials Design Report, right-of-way, long term maintenance, erosion control, traffic safety, appearance, economics of eliminating guardrail and drainage systems, and overall functional effectiveness and economy.

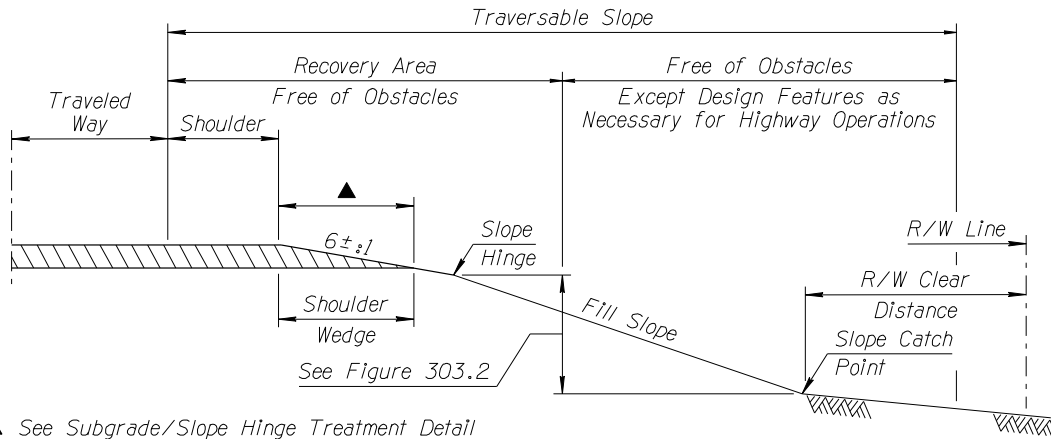

▲ See Subgrade/Slope Hinge Treatment Detail

**EMBAKMENT SECTION**

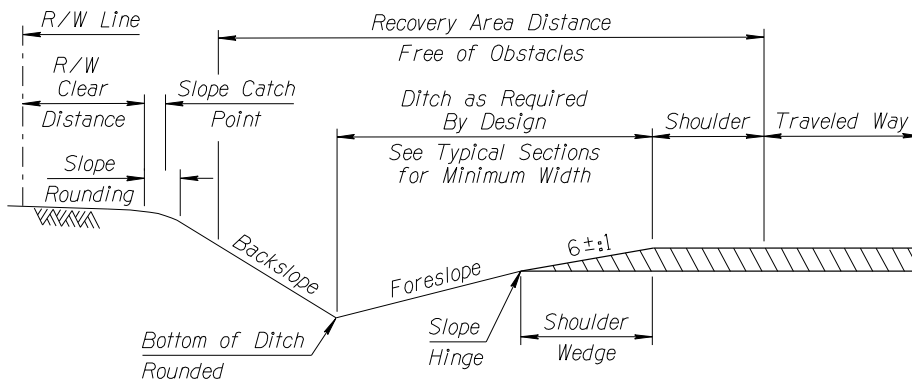

**CUT SECTION**

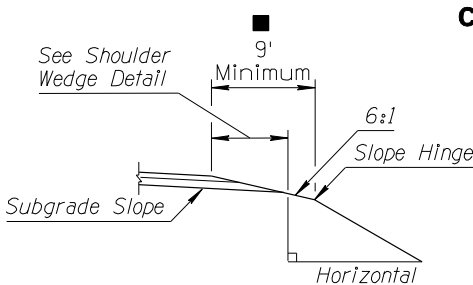

**Subgrade/Slope Hinge Treatment Detail**

■ The 9' minimum is required when guardrail is utilized on the project. Treatment shall be uniform throughout the project length. The 9' requirement may be waived under special conditions where guardrail is not utilized. The 9' minimum shall not be waived when the thickness of structure section has not been finalized.

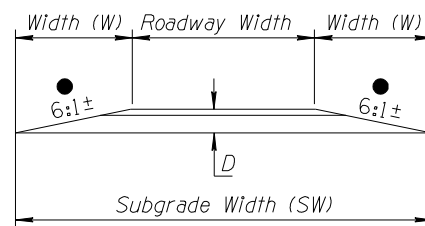

$W = D \times \text{Slope } (6:1)$   
 $D = \text{Str Sec Depth (Ft) Excluding ACFC}$   
 $SW = 2 \times W + \text{Roadway Width}$   
 ● = 4:1 With Concurrence of Roadway Group Manager

**Shoulder Wedge Detail**

**SIDE SLOPE NOMENCLATURE**  
**FIGURE 303.1**

**303.2 - Roadside Recovery Area**

Many highway crashes are the result of a vehicle leaving the pavement and striking an obstruction before having an opportunity to recover. The number and severity of the crashes may be reduced by providing a recovery area or clear zone outward from each outer travel lane that is free of obstructions and non-traversable slopes.

The recovery area width or horizontal clearance to obstructions should be determined based upon speed, volume, and embankment slope in accordance with Table 303.2A. Modification of the recovery area width for horizontal curvature using the factors in [Table 303.2B](#) is not required unless the crash history indicates otherwise. The recovery area width is designed and determined based upon the horizontal distance from the roadway plans typical section travel lane (normally 12 ft) to the near side of the obstruction.

| <b>Table 303.2A</b>                 |            |                |                 |   |
|-------------------------------------|------------|----------------|-----------------|---|
| <b>Recovery Area Width Criteria</b> |            |                |                 |   |
| Distances in Feet                   |            |                |                 |   |
| DESIGN SPEED                        | DESIGN ADT | FILL SLOPES    |                 | CUT SLOPES  |
|                                     |            | 6:1 OR FLATTER | 5:1 TO 4:1 INCL |   |
| 40 MPH OR LESS                      | Under 750  | 7-10           | 7-10            | Where fixed object obstructions are placed on cut backslopes the recovery area width requirement should meet the recovery area width indicated by the fill slope table shown utilizing the foreslope of the cut as the appropriate fill slope rate. |
|                                     | 750-1500   | 10-12          | 12-14           |   |
|                                     | 1500-6000  | 12-14          | 14-16           |   |
|                                     | Over 6000  | 14-16          | 16-18           |   |
| 45-50 MPH                           | Under 750  | 10-12          | 12-14           |   |
|                                     | 750-1500   | 12-14          | 16-20           |   |
|                                     | 1500-6000  | 16-18          | 20-26           |   |
|                                     | Over 6000  | 18-20          | 24-28           |   |
| 55 MPH                              | Under 750  | 12-14          | 14-18           |   |
|                                     | 750-1500   | 16-18          | 20-24           |   |
|                                     | 1500-6000  | 20-22          | 24-30           |   |
|                                     | Over 6000  | 22-24          | 26-30           |   |
| 60 MPH                              | Under 750  | 16-18          | 20-24           |   |
|                                     | 750-1500   | 20-24          | 26-30           |   |
|                                     | 1500-6000  | 26-30          | 30              |   |
|                                     | Over 6000  | 30             | 30              |   |
| ≥ 65 MPH                            | Under 750  | 18-20          | 20-26           |   |
|                                     | 750-1500   | 24-26          | 28-30           |   |
|                                     | 1500-6000  | 28-30          | 30              |   |
|                                     | Over 6000  | 30             | 30              |   |

Table 303.2B

## Curvature Modification Factors For Recovery Area Widths

| CURVE<br>DEGREE<br>$D_c$ | DESIGN SPEED (MPH) |      |      |      |      |      |      |
|--------------------------|--------------------|------|------|------|------|------|------|
|                          | 40                 | 45   | 50   | 55   | 60   | 65   | 70   |
| 2.00                     | 1.08               | 1.10 | 1.12 | 1.15 | 1.19 | 1.22 | 1.27 |
| 2.50                     | 1.10               | 1.12 | 1.15 | 1.19 | 1.23 | 1.28 | 1.33 |
| 3.00                     | 1.11               | 1.15 | 1.18 | 1.23 | 1.28 | 1.33 | 1.40 |
| 3.50                     | 1.13               | 1.17 | 1.22 | 1.26 | 1.32 | 1.39 | 1.46 |
| 4.00                     | 1.15               | 1.19 | 1.25 | 1.30 | 1.37 | 1.44 |      |
| 4.50                     | 1.17               | 1.22 | 1.28 | 1.34 | 1.41 | 1.49 |      |
| 5.00                     | 1.19               | 1.24 | 1.31 | 1.37 | 1.46 |      |      |
| 6.00                     | 1.23               | 1.29 | 1.36 | 1.45 |      |      |      |
| 7.00                     | 1.26               | 1.34 | 1.42 |      |      |      |      |
| 8.00                     | 1.30               | 1.38 | 1.48 |      |      |      |      |
| 9.00                     | 1.34               | 1.43 |      |      |      |      |      |
| 10.00                    | 1.37               | 1.47 |      |      |      |      |      |
| 15.00                    | 1.54               |      |      |      |      |      |      |

The AASHTO "A Policy on Geometric Design of Highways and Streets" provides guidelines for minimum horizontal clearance to obstructions for the various classifications of roadways.

For non-urban (without curb and gutter) highway sections having unprotected fill slopes from 3:1 to less than 4:1, fixed objects should be located beyond the toe of slope as discussed in the AASHTO Roadside Design Guide Table 3.1.

In general, fill slopes flatter than 4:1 are considered to be recoverable slopes and should be kept free of fixed obstacles in accordance with [Table 303.2A](#).

Fill slopes designed at a slope rate of 4:1 are considered to be traversable and may not be recoverable. Fill slopes designed at 4:1 are not recommended for fill heights approaching 25 ft due to the added difficulty for a driver to control their vehicle and economic considerations for barrier placement. For this reason, 4:1 slopes should be free of fixed obstacles to desirably 15 ft but no less than 10 ft beyond the toe of slope with the following exception: individual features of design necessary for highway operations may be located on unprotected fill slopes if they are located beyond the recovery area given in [Table 303.2A](#) or 30 ft from the outer travel lane, whichever is less. When additional recovery area is provided on curves, the additional width should be located assuming an errant vehicle will most likely follow a tangential path.

Planting of new trees with trunk diameters expected to grow to 4 in. in diameter and greater should observe the recovery areas provided in [Table 303.2A](#).

On high-speed rural highways, trees with trunks greater than 4 inches in diameter on or at the toe of fill slopes will be identified for removal within the recovery area or beyond. When located on Forest Service lands or other sensitive environmental areas, actual removal will be based upon agreement with the appropriate agency. Placement of new guardrail for trees which cannot be removed within the recovery area should only be done where accident history would indicate a barrier would be warranted.

The recovery widths determined from [Table 303.2A](#) are not absolute. There is not a specific distance beyond which the introduction of necessary fixed object features is encouraged. The designer should exercise good judgment in locating signs, light standards, landscaping, control cabinets and other similar features. Where new cut ditch foreslope/backslope interface is located within the clear zone, the backslope will not be considered a fixed obstacle if the backslope is reasonably uniform.

Recovery widths are not always available within the ADOT right-of-way, particularly in restricted urban and suburban environments. ADOT has no control of features located outside the ADOT owned right-of-way that are within desired recovery widths. Practical treatments within the right-of-way that would not create a less desirable condition can be considered.

Drainage channels parallel to the roadway should be located outside the recovery area. When conditions will not allow, channel slopes located within the recovery area should meet the preferred channel cross-section guidelines recommended in the AASHTO "Roadside Design Guide". The use of longitudinal barrier should be considered where the above conditions cannot be provided.

For new construction in urban environments having curbs or curb and gutter, the recovery area distances in [Table 303.2A](#) are desirable since curbs do not provide significant redirection capability except at very low speeds. Due to the location of existing roadside features, topography and space restrictions it may not be practical to meet the desired clear zone distances. As much clear zone as practical should be provided but in no case should an obstacle be closer than 1.5 ft from face of curb. **Where obstructions exist behind vertical curbs or curb and gutter sections in urban areas, a minimum horizontal clearance of 1.5 ft shall be provided beyond the face of curb to the obstruction.**

Roadside obstacles, non-traversable hazards and fixed objects, should be removed, made 'breakaway', relocated or shielded by barrier if they are within the minimum recovery area width. However, a barrier should be installed only if it is clear that the barrier offers a lesser hazard potential. Particularly in rural areas, the designer should strive to eliminate the need for barriers.

Warrants for embankment section barrier are shown in [Figure 303.2](#) except as noted in the following paragraph. In general, 4:1 or flatter fill slopes are desirable for new construction to eliminate the need for barrier based on slope rate. It is not normally economically feasible to flatten high fill slopes to a 4:1 rate. Also, high fill slopes are not desirable for a vehicle to negotiate when leaving a high speed facility. Therefore it is not generally recommended that 4:1 fill slopes be utilized to eliminate the need for barrier when slopes approach 25 ft or higher. Careful consideration of economics, speed, geometrics, location and topography should be done before utilizing 4:1 slopes on high fills.

The AASHTO Roadside Design Guide Figure 5.1 may be utilized for determination of warrants for embankment section barrier when all of the following conditions are met:

- a) The urban roadway typical section with curb and gutter is utilized (Sections UA & UB – Figure 306.4A). For traffic interchanges, this condition may be applied outside of the crossroad ramps.
- b) The posted speed for the highway is 45 mph or less.
- c) Slopes of 4:1 or flatter cannot be achieved due to limitations in R/W availability or other physical restraints. The designer should demonstrate that there are no feasible alternatives. The flattest slopes possible should be provided within the constrained area.

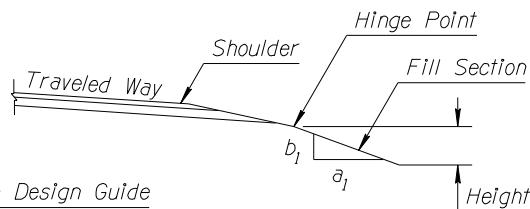
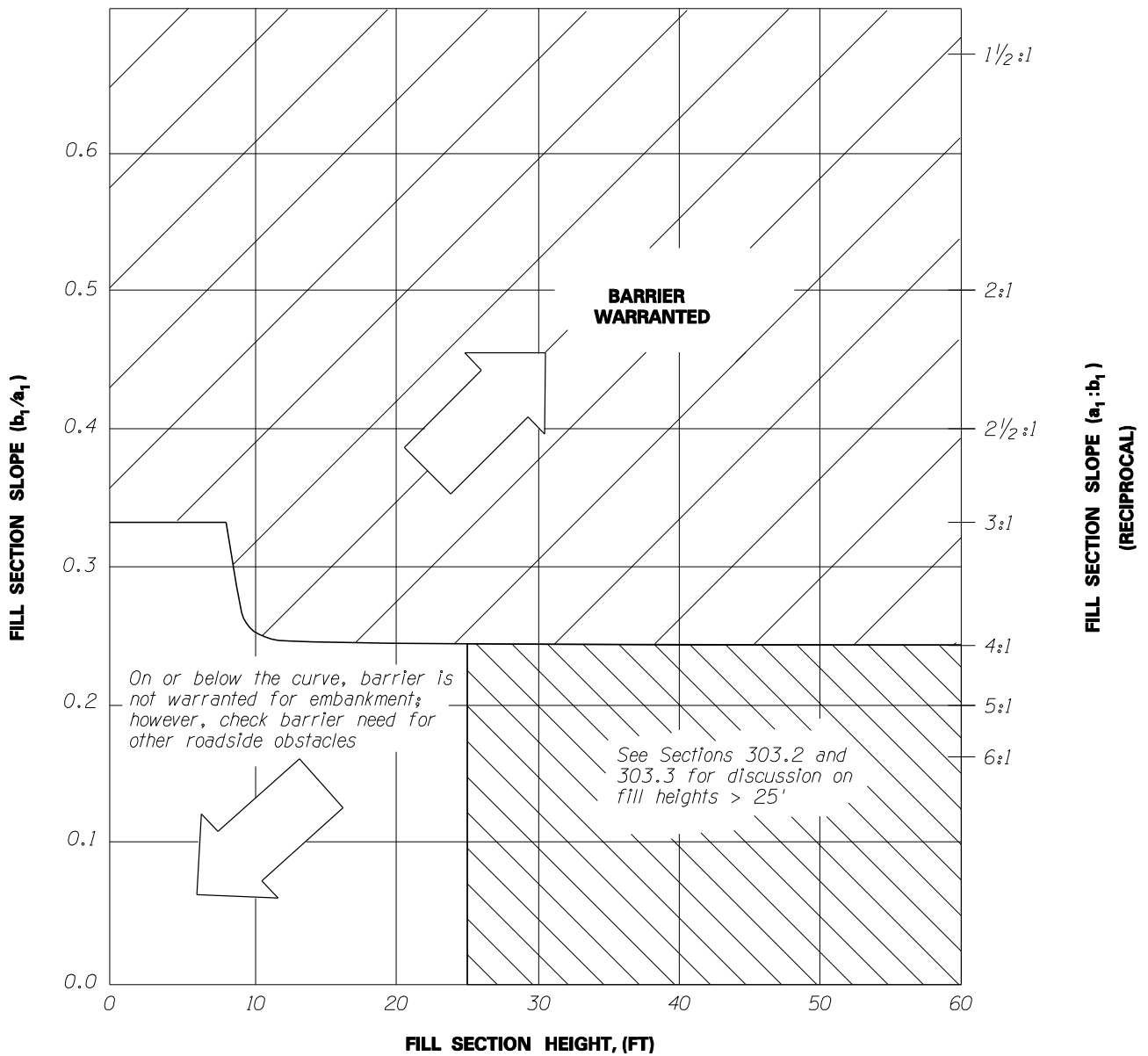

Source:  
AASHTO Roadside Design Guide

**BARRIER WARRANTS FOR EMBANKMENT SECTIONS**  
**FIGURE 303.2**

### 303.3 - Side Slopes

As shown in [Figure 303.1](#), the top of subgrade on uncurbed roadways is staked in the field by measuring from the outside edge of the shoulder a distance equal to six times the pavement structural section thickness (not including the ACFC). The pavement structural section is sloped between the top edge of the subgrade and the edge of shoulder (the "shoulder wedge"). This sloped face of the shoulder wedge is shown on typical sections and standard drawings as being a nominal 6:1. In rare instances, a nominal 4:1 shoulder wedge slope as shown in Standard Drawing C-02.30 may be considered. However, the use of a nominal 4:1 slope should be limited to minor roads, sideroads, temporary roads and connectors having low speeds and low ADTs. **Usage of a shoulder wedge steeper than a nominal 6:1 slope on State highway system roadways shall have the approval of the Assistant State Engineer, Roadway Engineering Group.**

In no case should the slope hinge point be located inside the shoulder wedge.

The designer should consider adjusting the Construction Standard roadway embankment slopes and/or profile grade to eliminate the need for embankment guardrail. See [Figure 303.2](#).

Engineering judgment should be applied in adjusting embankment slopes to eliminate guardrail or for other purposes. Slopes of 4:1 or flatter are not normally used for fill heights approaching 25 feet. See discussion in [Section 303.2](#). Economic justification is required when these slopes are proposed for higher fill slopes.

Likewise, the "barn-roof" approach should not be used to eliminate guardrail. Superficially, it would appear that providing a relatively flat slope throughout the minimum recovery area followed by a steeper slope -- a "barn roof" section -- would minimize the embankment footprint without the need for guardrail. However, as discussed above, the recovery area width is not an absolute dimension. The sharp slope change at the edge of the minimum recovery area could introduce an unsafe situation and this solution is undesirable.

In cut sections, the slope of the ditch foreslope should be 6:1 or flatter.

The width of the ditch bottom is to be based on drainage requirements. The bottom of the ditch should be 1 ft minimum below the pavement structural section. See [Chapter 600](#) for other ditch drainage criteria. Cut and fill slopes should initially be designed as shown in the C-02 series of the Construction Standard Drawings. Final slopes are then incorporated into the design and shown on the plans as required by the Project Geotechnical Report, Material Design Report, and other considerations such as slope flattening for elimination of barrier, cut widening to facilitate drainage, rockfall, landscape and vegetation establishment, and visual mitigation.

### **303.4 - Topsoil Plating**

In urban areas, the roadway side slopes and median slopes may be plated with topsoil to accommodate vegetation used for landscaping. The need for topsoil plating will be established by Roadside Development Section. Topsoil plating is not normally provided for rural highways. See [Section 703.5](#) for additional discussion on topsoil plating.

### **303.5 - Cross-Facility Embankment Slopes**

The embankments of side roads, turnouts, drainage dikes, median crossovers and similar appurtenant facilities are considered to be obstacles within the recovery area. To mitigate these obstacles, their embankment slopes should desirably be no greater than 10:1 within the recovery area. Where such flat slopes are not practical, a 6:1 minimum embankment slope may be used.

The top and bottom of the cross embankment slopes should be rounded to minimize the potential for an errant vehicle to become airborne. Where culverts under turnouts or side roads are located within the recovery area, consideration should be given to safety end sections.

### **303.6 - Clearance From Slope to Right-of-Way Line**

A minimum clearance of 10 ft should be provided between the right-of-way line and the toe of a fill slope. For cut slopes, the clearance from the outer edge of slope rounding or crown drainage system should be 10 ft.

High slopes approaching 25 ft may require greater clearances to the right-of-way line for maintenance or slope stability purposes. The designer should consult with Materials Group and District personnel regarding the need for clearances greater than 10 ft at high slopes.

### **303.7 - Slope Benches and Cut Widening**

Slope benches should be provided only as recommended in the Project Material Design Report.

Normally, benches should be sloped to form a ditch with the low point near the toe of the upper slope. The grade of the bench ditch should provide for positive drainage to avoid ponding of water on the bench. The dimensions of the bench, and the bench ditch should be developed in concert with the Materials Group. Wherever feasible, access for maintenance equipment should be provided at all slope benches.

Widened cut ditches are preferred where they are acceptable as alternatives to slope benches.

Cut widening may be necessary to provide for adequate drainage, to intercept and store loose material which may fall from the slope, and to provide storage for snow removal. The need for widened cuts should be coordinated with the roadway drainage designers, the District Engineer, Materials Group and other appropriate sections and agencies.

### 303.8 – False Cuts

A false cut consists of utilizing excavated material to form a cut ditch, back slope to a specified height, berm and a back-side fill slope within the available right-of-way. False cuts are used at selected locations as a means to dispose of excess excavation primarily on grade and drain projects where wasting of excavated material is undesirable due to unavailability of waste sites in close proximity to the project and the additional hauling costs involved. False cuts are considered when other available methods such as profile grade adjustments and slope flattening are exhausted or not practical. In many instances, false cuts can be constructed to be a continuation or connection of selected adjacent cut ditches on the project. The designer should carefully consider the following issues in the design of a false cut:

- a) The backslope rate in combination with the height should be steep enough to prevent vehicles traversing over the top;
- b) Onsite drainage requirements for the new ditch;
- c) Extension of drainage structures under the expanded roadway prism. (Additional cost);
- d) Available right-of-way;
- e) Environmental considerations; and
- f) Erosion and maintenance issues associated with continuous steep ditch gradelines.

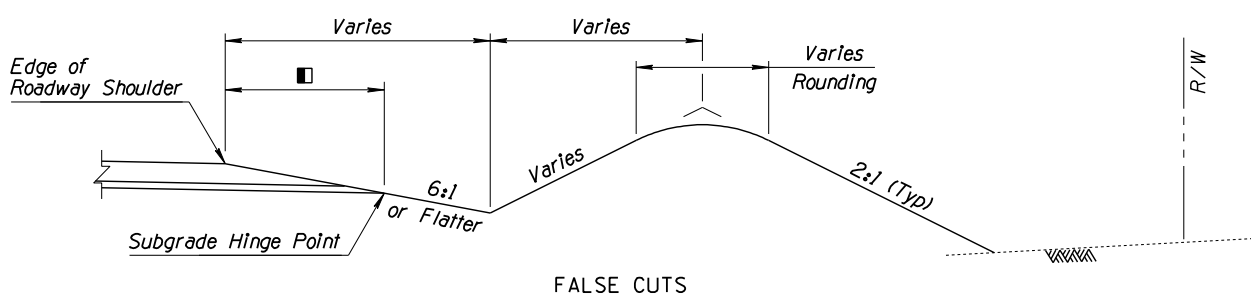

■ See Figure 303.1

### **303.9 - Special Slope Treatments**

The highway designers should coordinate with Roadside Development Section regarding special slope treatments necessary to encourage re-vegetation, to reduce erosion potential, or to accommodate landscaping requirements. Special treatments may include laying back or varying the side slopes, incorporating slope steps, mini-benching, slope mattresses or other soil stabilization treatments.

## **304 - Medians**

### **304.1 - General**

This section covers State highways only. Medians in local roads at traffic interchanges are covered in [Chapter 500 – Traffic Interchanges](#).

The median width on divided roadways is the distance between edges of the inside through travel lanes.

Median width on rural highways should be based upon the characteristics of the terrain through which the highway passes.

In rural areas, the desirable median width of 84 ft should be used where the terrain or other physical features do not make construction impractical or overly costly and where right-of-way costs are not disproportionate to the total project costs. A wider or variable width median should be used where the terrain lends itself to independent roadway alignments for economic or aesthetic reasons (see [Section 204.6](#)).

In establishing the median width, careful consideration should be given to the grading and drainage of the median with special attention to the roadway superelevation and the depth of the pavement structural section. In addition, the capacity and operation of the intersection is affected by the median width. Consideration must be given to the operational characteristics of very long trucks and other vehicles using the intersection.

**The minimum median width on rural highways shall be 50 ft.** See [Section 304.4](#) for discussion on guidelines for median barriers.

A closed median section may be used for rural divided highways in those instances of very restricted rights-of-way, or where the terrain or other physical features make wider medians impractical or costly. In such cases, the roadways should be separated by a concrete barrier and the median shoulders widened by 2 ft. The areas where the closed section is used must have very limited side road access requirements. Barrier breaks for necessary crossings or turn lanes must be restricted to areas with acceptable sight distances for both mainline and side roads.

In improving the capacity of rural highways, it is often prudent to utilize the existing two-lane highway as one direction of a new divided highway. In such cases, the median width should be set (or varied) to minimize the total project cost, including both construction and right-of-way, but with consideration of drainage, median slopes, maintenance of traffic, superelevation, and cross access. It is important to provide sufficient separation to allow generally independent construction of the roadways where possible and feasible to facilitate maintenance of traffic.

For non-controlled-access highways in urban areas, curbed medians should generally be 16 ft wide from face of curb to face of curb.

For controlled-access highways in urban areas, the median width should be based on the need to provide for potential future additional traffic lanes or for possible alternative modes of transportation. In general, a 50 ft wide median should be provided. This width median will accommodate future construction of an additional lane in each direction, an increased median shoulder width and offset to the median barrier.

### **304.2 - Widening for Bridge Piers**

In designing highways with closed medians in either the initial or ultimate configuration it is important to check the horizontal clearance to bridge piers located in the median and to the barrier protection provided for the piers. The horizontal clearance to the pier should be as discussed in [Section 308](#); i.e., the clear shoulder width shall be provided as per Table 302.4.

Where the horizontal clearance to a pier cannot be provided as required by [Section 308](#), the median should be widened. If the pier is located in a tangent section, the widening should be accomplished from one curve to the next; if in a curve, the widening should be limited to the curve.

### 304.3 - Median Cross Slopes

Examples of median cross slope design are shown in Figures 304.3A-C.

[Figure 304.3A](#) shows 46-50 ft median configurations in rural or fringe-urban settings. The highway median should be sloped downward from the subgrade hinge point at slope rates 6:1 or flatter but no steeper than 4:1. Slopes intersecting at 6:1 or flatter may require offset median control grades and are preferred over 4:1 slopes in the medians as long as drainage requirements can be met (See Chapter 600). Where 4:1 slopes are used and the median intersect is located toward a lower roadway, consideration may be given to utilization of barrier on the high side roadway, especially when on the outside of curvature.

[Figure 304.3B](#) shows the standard rural median width of 84 ft for freeways and major arterials. Slopes of 6:1 or flatter are desired and the slopes may be controlled at median centerline, at an offset intersect control line or may randomly intersect. Depressed medians are commonly used, however, when rocky material is encountered, the median area may be left undisturbed with appropriate cut ditch widths and slopes coordinated with Geotechnical Services.

[Figure 304.3C](#) shows 50 ft urban controlled access median treatments. Slope rates of 10:1 are desirable with 6:1 as the minimum desired rate. If slopes steeper than 6:1 are required due to curvature and profile controls, selection type and location of the median barrier must be considered. The design of urban controlled access highway medians must consider both the ultimate build-out condition and the interim condition of initial construction. The open median for the interim condition should be based upon the ultimate design. Generally, the ultimate condition will be a median barrier with contiguous shoulders and traffic lanes. The configuration of the median can vary depending upon the elevation differences of the two roadway edges and the median drainage requirements. The profile grade lines of the two roadways should be designed to minimize the vertical separation of the roadways at the median, balanced with providing an overall economical design with the bridge structures controlled by vertical clearances. Other design features such as utility locations, drainage systems and median barriers must be considered.

The ultimate design should be completed with the initial design so that final plans for the future median closure are available and can be utilized for the future median closure projects. Doing this will eliminate potential problems created by profiles and geometry that have not been adequately evaluated for final median closures. See [Figure 302.1](#) for the treatment of urban median shoulders outside of the pavement width.

Unpaved raised curb medians should be graded to drain toward the center of the median, at a slope of 10:1 or flatter, with 20:1 preferred.

Paved medians, including those with raised curbs, should be crowned at the center.

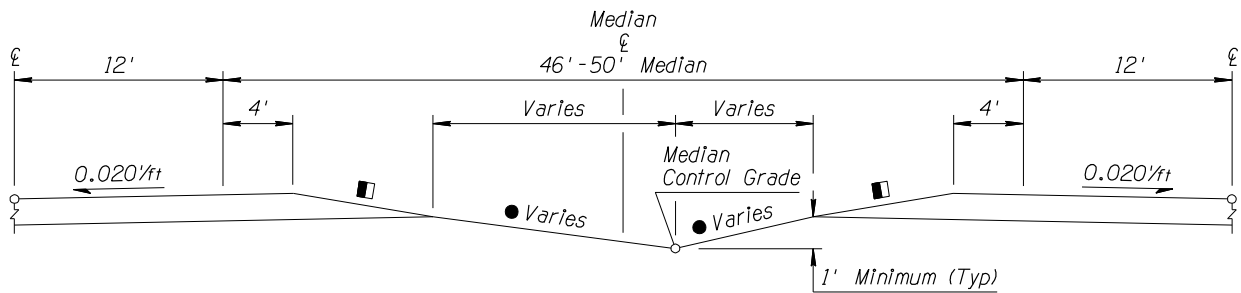

Slopes Vary with Control Grade  
 Dimensioned from Lower Roadway  
 with Station and Offset

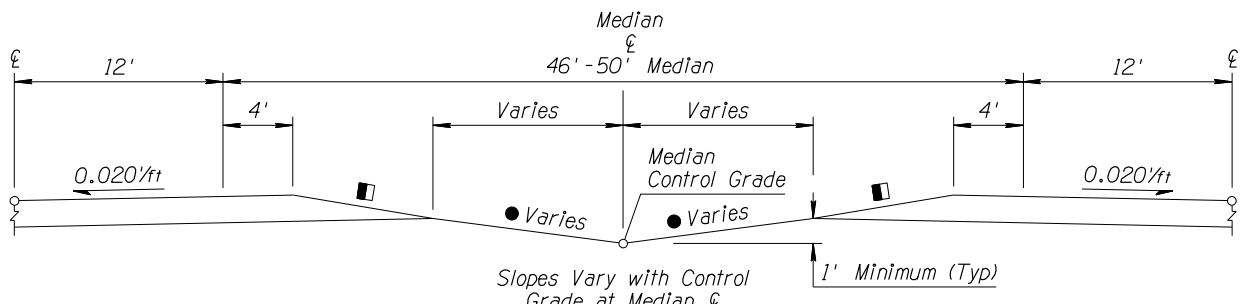

Slopes Vary with Control  
 Grade at Median

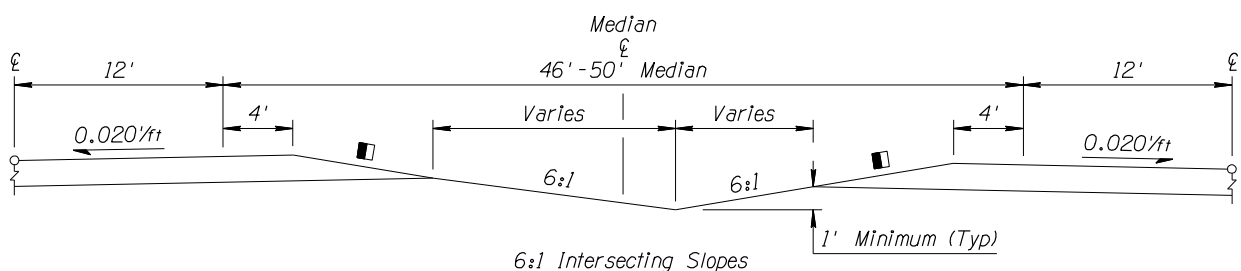

6:1 Intersecting Slopes

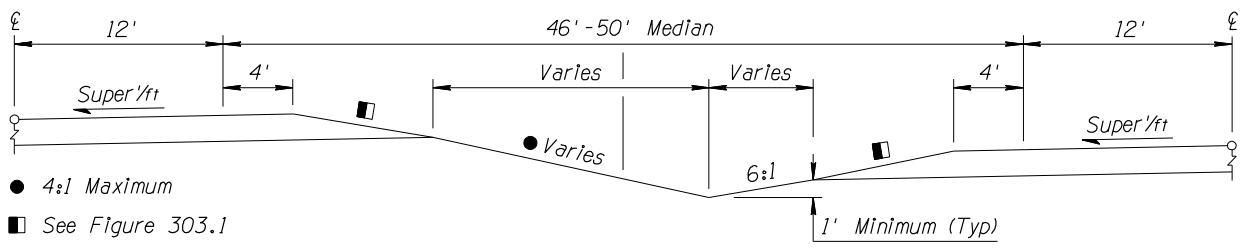

- 4:1 Maximum
- See Figure 303.1

See Section 304.4 for  
 Median Barrier Requirements

6:1 Slope from Lower Roadway

**RURAL & FRINGE-URBAN DIVIDED HIGHWAYS  
 46'-50' MEDIAN CONFIGURATIONS  
 FIGURE 304.3A**

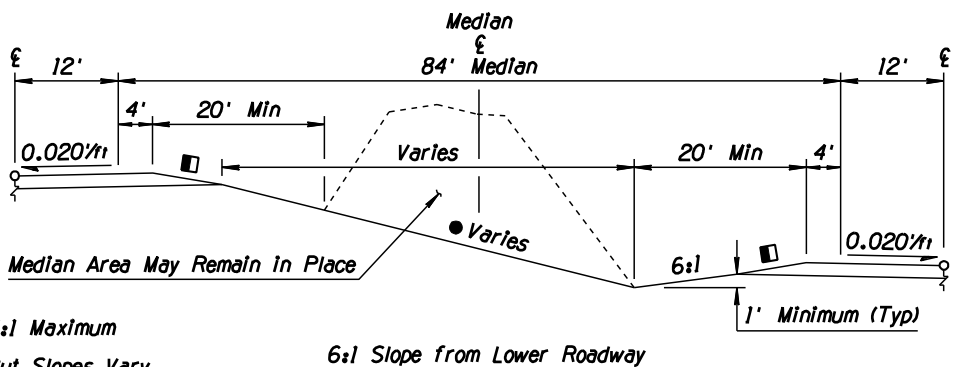
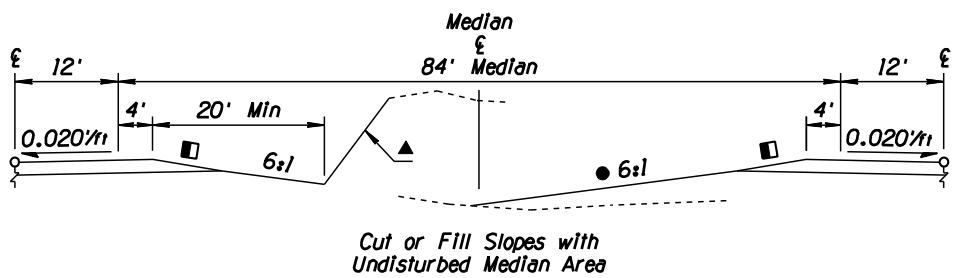
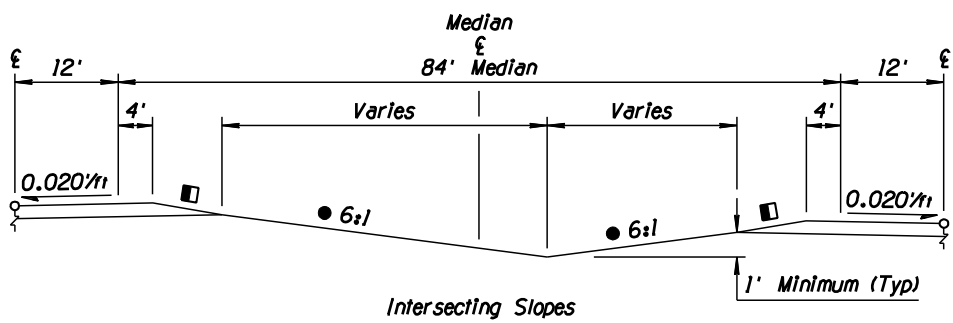
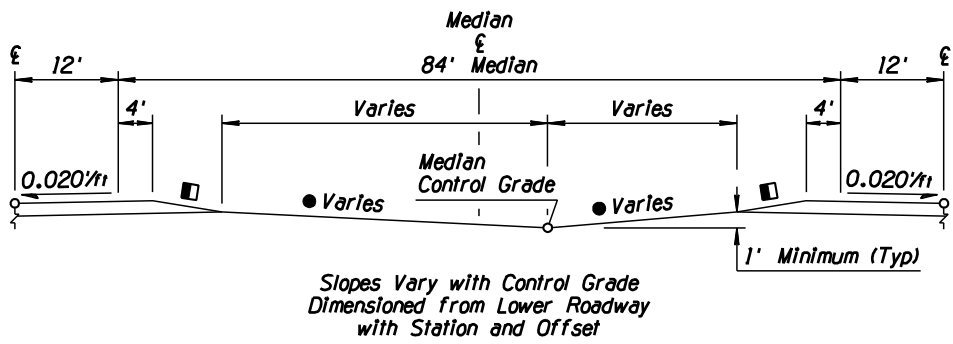

- 4:1 Maximum
- ▲ Cut Slopes Vary
- See Figure 303.1

6:1 Slope from Lower Roadway

**RURAL 84' MEDIAN CONFIGURATIONS**  
**FIGURE 304.3B**

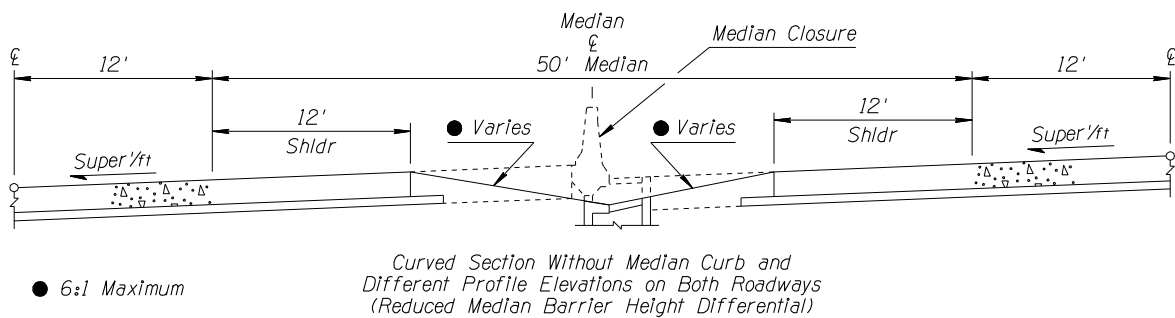
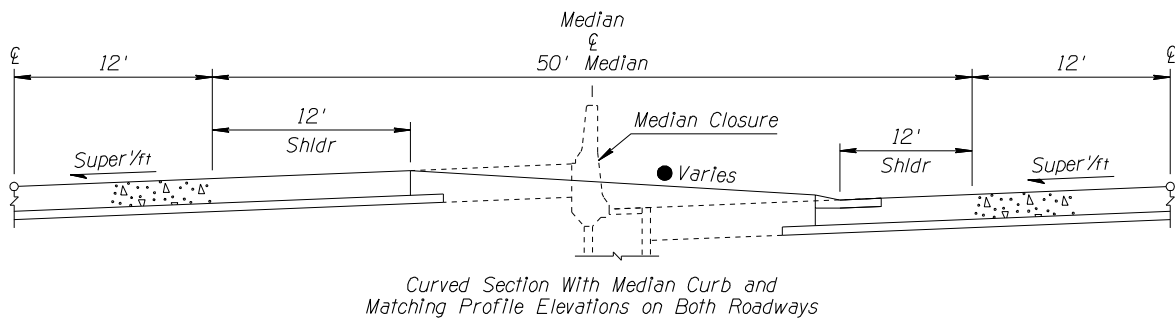
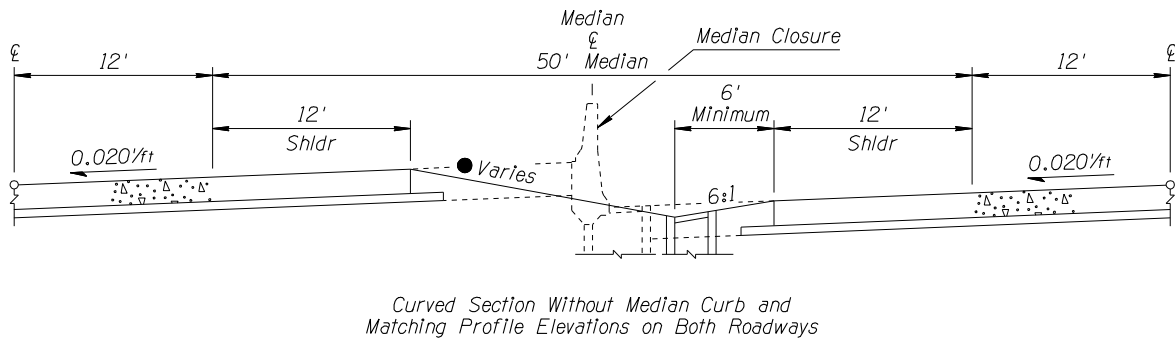
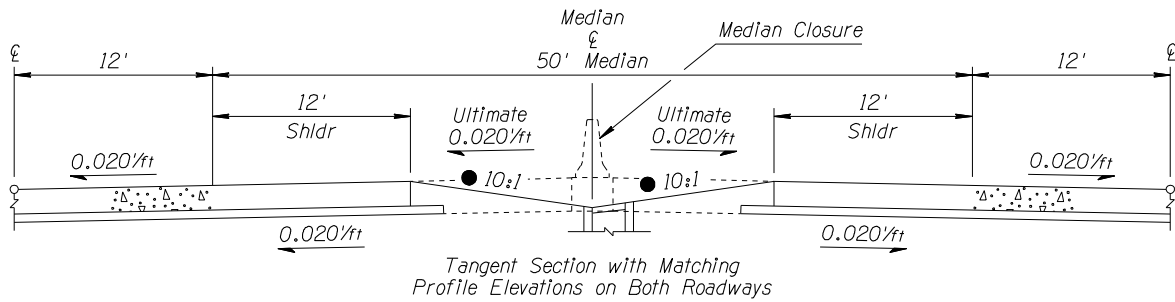

● 6:1 Maximum

**URBAN CONTROLLED ACCESS  
50' MEDIAN CONFIGURATIONS  
FIGURE 304.3C**

### **304.4 - Median Barriers**

The following guidelines apply for placement of median barriers with new construction:

**Median barriers shall be installed on high-speed fully controlled-access highways having traversable medians under the following conditions:**

- a) Median widths 50 ft and less.**
- b) Median widths 75 ft and less when there are three or more through lanes in each direction.**

In addition to the above criteria, median areas may require protection with barriers as warranted for other conditions such as steep slopes or fixed objects within the clear zone. See [Section 305.2](#) for discussion on barrier types.

With closed paved medians, glare screens should be provided for 32 in. and 42 in. high median barriers except that median barriers for urban freeway areas are constructed at a height of 42 in without glare screen when overhead lighting is provided.

### **304.5 - Median Curbs**

See Construction Std. Drawing C-05.10.

Type A or A-1 or single curb is used for non-controlled access urban and fringe urban highways. Raised landscaped medians having irrigation should use Type A-1 deeper curbing to serve as a moisture barrier in protecting the pavement structural section. Curb and gutter is used where catch basins are needed to pick up pavement drainage.

Controlled-access urban highways use urban freeway curb and gutter alternates in the median when required. Type E urban freeway curb (4" high) is used when PCCP is overlaid with 1" asphalt to achieve quiet pavement and maintain a 3" height for drainage design. Type C-1 and E-1 urban freeway curb and gutter alternates, sloping away from the high side of roadway, are used for continuity when the roadway curb section rotates to the high side.

### **304.6 - Paved Medians**

Raised medians not subject to landscaping, should be paved with a low maintenance surface material. The highway designer should consult with Roadside Development Section regarding the surface treatment. Treatment selection should be based upon ease of construction, cost, maintainability and aesthetics.

## **305 - Barriers**

### **305.1 - General**

Warrants for embankment section barrier are shown in [Figure 303.2](#).

**Barriers shall be used as required to shield errant vehicles from striking fixed obstructions within the roadside recovery area.** Obstructions include unyielding obstacles which cannot be made "breakaway". Application of the roadside recovery area criteria is described in [Section 303.2](#).

### **305.2 - Barrier Types**

Barrier types commonly utilized by ADOT include guardrail, safety-shape barriers, cable barriers and crash cushions. See the AASHTO Roadside Design Guide for discussion on all types of approved barriers. Barrier systems utilized on new projects are adopted for use through the ADOT Product Evaluation Program (PEP). New roadside barriers must meet the crash test requirements established by NCHRP and approved for use by FHWA.

### **305.3 - Guardrail**

The ADOT Construction Standard Drawings provide details for "W-beam" and "Thrie beam" types of guardrail with various support post systems. The W-beam guardrail is preferred for most applications. Either steel or timber strongpost W-beam systems may be used.

The Thrie beam type of guardrail installation is not generally used for new construction. Normal use is limited to those reconstruction projects where it is required to match existing guardrail, particularly on bridges and guardrail transitions to concrete barrier.

In the interest of overall economy and maintainability, guardrail should be installed parallel to the edge of pavement (i.e., not flared). With new construction, guardrail should be offset 2 ft from the outside edge of roadway shoulder (See Construction Standard Drawings for Type B guardrail installation). See the Roadway Design Memorandum entitled "[2-Foot Offset Distance to Roadside Barriers](#)" on the Roadway Design website. Where embankment guardrail is used, the fill slope hinge point is to be set a minimum of 9 ft from the normal edge of shoulder. (See [Figure 303.1](#))

When guardrail is flared from one offset width to another, the maximum flare rates for semi-rigid barrier in Table 5.7 of the AASHTO Roadside Design Guide should not be exceeded.

Guardrail end terminals should be provided at the approach end of a guardrail run and a guardrail anchor at the departure end. On undivided highways the guardrail end terminals

should be used at each end of the guardrail run. Alternative guardrail end treatments are shown on the Barrier Summary Sheet in the project plans. Design memorandums providing guidelines for the usage of various guardrail end terminals have been issued and are available on the Roadway Design website.

W-beam guardrail should be located at least 3 ft in front of an obstruction to provide space for the guardrail to deflect when struck by a vehicle. Other types of guardrail should be located to accommodate their maximum dynamic deflections upon impact (See AASHTO Roadside Design Guide). The distance is to be measured from the back of guardrail post to the nearest point on the rigid object.

### **305.4 - Safety-Shape Barriers**

ADOT Construction Standard Drawings give details for concrete safety-shape half barriers and median barriers with heights of 32 in. and 42 in.

The dimensions of the safety-shape barrier have been developed to redirect an errant vehicle back to the roadway in a controlled manner. The dimensions of the roadway face of the safety-shape barrier should not be changed from those given in the Standard Drawings. In particular, the 3 in. vertical or battered face at the base of the barrier must not be increased. (The sole purpose of the face is to accommodate future pavement overlays.)

Barrier heights of 32 in. and 42 in. are shown in the Construction Standard Drawings. When conditions require greater heights, the upper face may be extended either in its plane or vertically as necessary. Higher barriers should be checked for stability and structural adequacy.

The safety-shape barrier redirects vehicles through its mass and shape; it is a rigid barrier. Since it does not deflect like the flexible guardrails, there is no need for an offset between the back of the barrier and a roadside obstacle. This barrier is most effective when placed parallel to the roadway and offset from the shoulder by 2 ft. The paved shoulder should be extended to the barrier. See the Roadway Design Memorandum entitled "2-Foot Offset Distance to Roadside Barriers" on the Roadway Design website.

Where concrete barriers flare from one offset width to another, the maximum flare rates for rigid barriers shown in Table 5.7 of the AASHTO Roadside Design Guide should not be exceeded.

Cutouts/leaveouts in the median barrier face for placement of lighting poles or other utilities should be avoided in order to avoid possible vehicle snagging.

### 305.5 - Cable Barriers

Cable barrier systems are flexible systems which may be applied in medians or on the roadside. Cable barrier systems have commonly been utilized for median applications as a temporary barrier system until such time that the ultimate median closure having permanent concrete barrier is programmed and constructed. Cable barriers on the outside of the roadway are used only for special applications.

Cable barrier systems having pre-stretched cables are now available and offer the advantages of lower deflections, improved containment of errant vehicles and improved ease of maintenance.

The key design elements in utilizing cable barrier systems are a) insuring adequate deflection distance is available; b) placement of system on approach slopes of 6:1 or flatter; c) placement of end anchors at intervals not to exceed the system design and d) placement of system on a uniform surface. Deflections may be decreased by reducing the post spacing. Most of the new pre-stressed cable systems are proprietary and additional information is available from the various manufacturers.

### 305.6 - Crash Cushions

Crash cushions are protective devices to prevent errant vehicles from impacting obstructions within the recovery area that cannot be otherwise removed, relocated, or made breakaway. When hit head on, a crash cushion smoothly decelerates the vehicle to a stop.

Most crash cushions are redirectional and when hit at an angle can redirect an errant vehicle away from the obstruction. Sand barrels, however, are not redirectional and should not be used in gore areas where side impacts are likely to occur. In urban areas, sand barrels are preferred over safety shape barriers to shield individual obstructions within the recovery area (e.g. temporary light structures in the median). In rural areas, guardrail should normally be used.

**When considering various crash cushions for use, the Roadway Engineering Group “[Crash Cushion Selection Procedure](#)” shall be utilized and is available on the Roadway Design website.** The designer must become familiar with the design requirements for each device considered and insure that the layout details are properly utilized according to the manufacturer recommendations. Design manuals are available to designers from the various manufacturers. The manufacturers provide technical assistance for their products upon request.

### **305.7 - Guardrail and Embankment Curbs**

**Where embankment curbs are required to prevent slope erosion in high speed areas, guardrail shall be provided along the length of the required curb and inlet treatments in accordance with the Construction Standard Drawings.** The curb height should not exceed 4 inches.

Where guardrail is provided for steeper slopes or high embankments, embankment curb can be considered a suitable erosion control measure. In other areas that do not require guardrail for slope protection, other erosion control measures, if needed, should be implemented to eliminate the need for embankment curb.

In limited applications for low speed areas, embankment curb may be used without guardrail where the slopes behind the curb do not warrant the use of guardrail.

### 305.8 - Barrier Length

The length of need for approach barrier is computed by the formula:

$$L = \left(1 - \frac{A}{B}\right)R$$

Where:

$L$  = Length of need;

$A$  = Distance from edge of travel way to barrier;

$B$  = Distance to far end of hazard from travel way; not to exceed the determined clear zone width

$R$  = Runout length based on design speed, ADT as shown in Table 305.8. Ref: AASHTO Roadside Design Guide

The above formula for determination of length of need can be applied to protect fixed objects within the clear zone. [Figure 305.8](#) depicts how the formula is applied for placement of approach barriers for one-way and two-way traffic. For two-way traffic, the guardrail should extend on each side of the obstruction as required by the length of need formula for each direction of traffic. A crashworthy end treatment is placed beyond the determined length of need for the barrier.

| <b>Table 305.8<br/>Roadside Barrier Runout Length</b> |                             |                         |                         |                         |
|---|-----------------------------|-------------------------|-------------------------|-------------------------|
| <b>Design<br/>Speed<br/>(mph)</b>                     | <b>Traffic Volume (ADT)</b> |                         |                         |                         |
|   | <b>Over 10,000</b>          | <b>5,000-10,000</b>     | <b>1,000-5,000</b>      | <b>Under 1,000</b>      |
|   | <b>Length<br/>R(ft)</b>     | <b>Length<br/>R(ft)</b> | <b>Length<br/>R(ft)</b> | <b>Length<br/>R(ft)</b> |
| <b>80</b>   | <b>470</b>                  | <b>430</b>              | <b>380</b>              | <b>330</b>              |
| <b>75</b>   | <b>415</b>                  | <b>380</b>              | <b>335</b>              | <b>290</b>              |
| <b>70</b>   | <b>360</b>                  | <b>330</b>              | <b>290</b>              | <b>250</b>              |
| <b>65</b>   | <b>330</b>                  | <b>290</b>              | <b>250</b>              | <b>225</b>              |
| <b>60</b>   | <b>300</b>                  | <b>250</b>              | <b>210</b>              | <b>200</b>              |
| <b>55</b>   | <b>265</b>                  | <b>220</b>              | <b>185</b>              | <b>175</b>              |
| <b>50</b>   | <b>230</b>                  | <b>190</b>              | <b>160</b>              | <b>150</b>              |
| <b>45</b>   | <b>195</b>                  | <b>160</b>              | <b>135</b>              | <b>125</b>              |
| <b>40</b>   | <b>160</b>                  | <b>130</b>              | <b>110</b>              | <b>100</b>              |
| <b>35</b>   | <b>135</b>                  | <b>110</b>              | <b>95</b>               | <b>85</b>               |
| <b>30</b>   | <b>110</b>                  | <b>90</b>               | <b>80</b>               | <b>70</b>               |

Gaps between the ending of a guardrail run and the beginning of another guardrail run that are less than 200 ft should be eliminated where practical for continuity and economic considerations.

Guardrail end anchors should be used on the departure end of guardrail runs along one-way roadways thus decreasing the amount of guardrail required. (An end anchor section will develop a rail tensile strength equivalent to that developed by 50 ft of in-place guardrail.) Guardrail end anchors can be placed opposite the end of the obstruction except that when the obstruction is 6 ft or less from the face of the guardrail, the 12.5 long end anchor should extend beyond the obstacle. When a guardrail end anchor is not used, the guardrail should end approximately 50 ft beyond the obstruction.

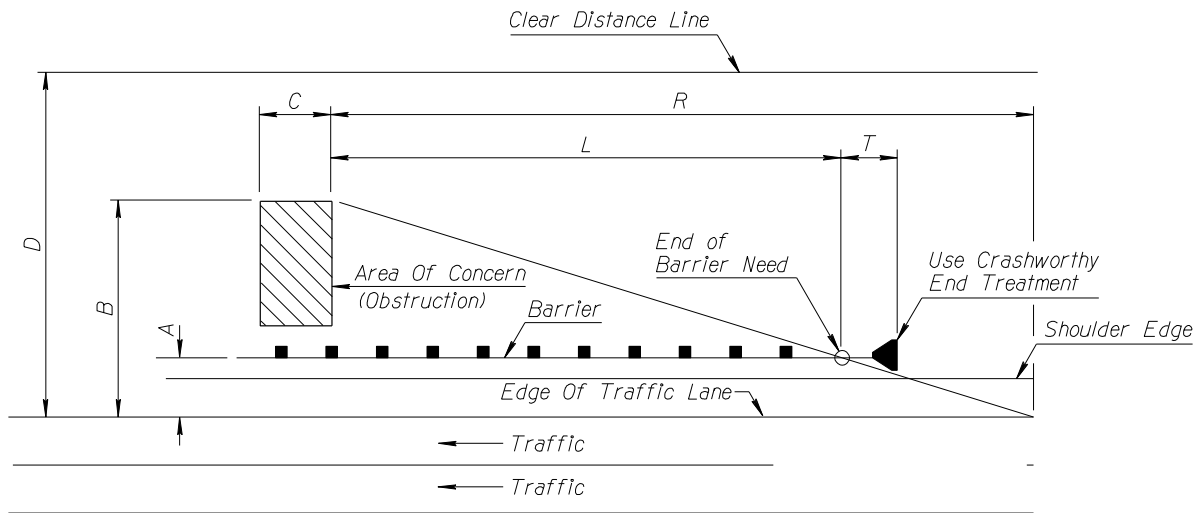

**ONE-WAY TRAFFIC**

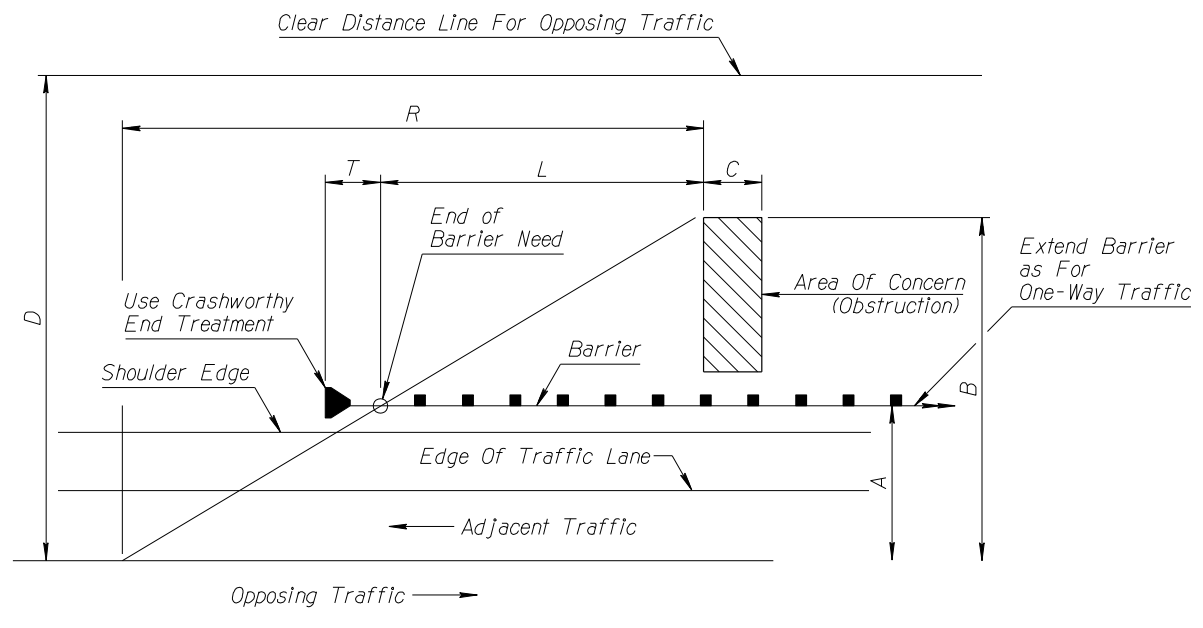

**TWO-WAY TRAFFIC**

- $R$  = Runout Length Approaching, See Table 305.8.
- $T$  = Guardrail End Treatment.
- $L$  = Barrier Length From Obstruction To End Of Barrier Need.
- $A$  = Distance From Edge Of Travel Lane To Barrier.
- $B$  = Distance To Far End Of Obstruction.
- $C$  = Length Of Obstruction Or Immovable Object.
- $D$  = Recovery Area Width.

**APPROACH BARRIER FOR ONE & TWO-WAY TRAFFIC**  
**FIGURE 305.8**

### 305.9 - Barrier Transitions

Transition sections are necessary to provide continuity of protection when two different roadside barrier systems join, when roadside barriers join another barrier system (i.e., bridge rail), or when a roadside barrier is attached to or adjacent to a rigid object such as a bridge pier. Standard transition sections for attachment of guardrail to safety-shape barrier are shown in the Construction Standard Drawings.

Transitions are also required for safety-shape median barrier when bridge piers, sign poles or light standards are located in the median. For single and multiple column piers and sign bases it is preferred to maintain the safety-shape median barrier using a flare transition as shown in [Figure 305.9](#) where there will be adequate horizontal clearance to the face of the barrier (See [Section 308](#)). Taper rates for the concrete barrier flare are discussed in [Section 305.4](#). If the required horizontal clearance cannot be provided to the face of barrier, a transition to vertical may be used. Note: providing horizontal clearance to the face of the flared transition barrier is not, by itself, reason to widen the median as described in [Section 304.2](#). However, if the median must be widened to provide horizontal clearance to the bridge pier, consideration should be given to the extra widening required to provide horizontal clearance to the face of safety shape barrier using the flared transition.

For light poles located in the median, a configuration as shown in [Figure 305.9](#) with the top of the median barrier having adequate width to place the pole anchor should be utilized in lieu of notching the barrier and placing the anchor at a location below the top of the barrier.

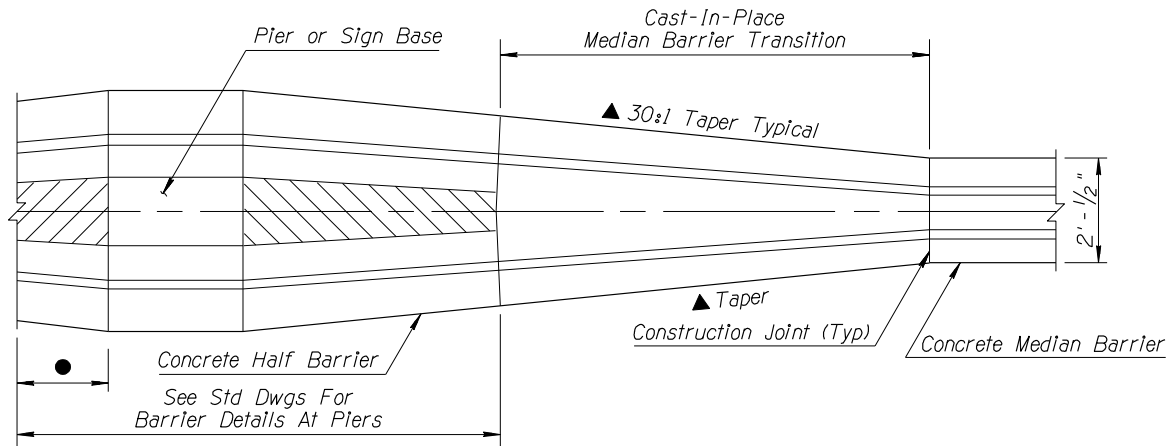

**PLAN**  
**Method To Maintain Safety Shape**  
**MEDIAN BARRIER FLARE**

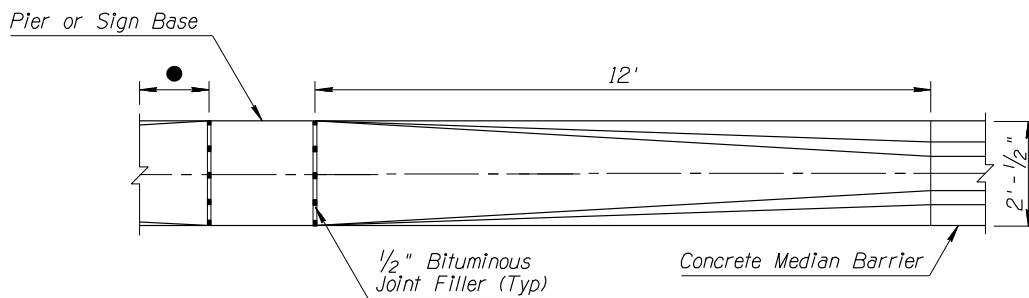

**PLAN**  
**Method To Maintain Continuous Shoulder Width**  
**MEDIAN BARRIER TRANSITION TO VERTICAL**

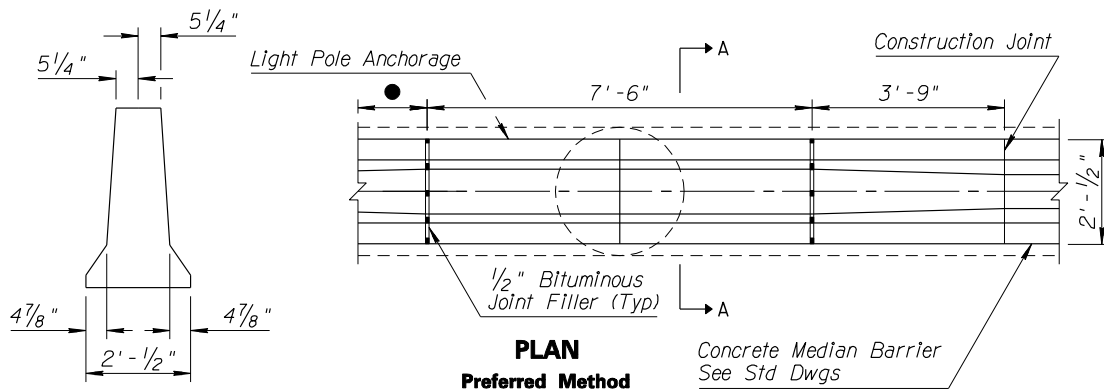

**PLAN**  
**Preferred Method**  
**LIGHT POLE ANCHORAGE**

- Symmetrical To Opposite Side
- ▲ See AASHTO Roadside Design Guide, Table 5.7

**MEDIAN BARRIER TRANSITION**  
**AT PIERS, SIGN BASE**  
**AND LIGHT POLE**  
**FIGURE 305.9**

### **305.10 - End Treatment**

**Unshielded ends of longitudinal barrier within the clear zone shall have crashworthy end treatments.** At very low speeds a vertical transition end to a concrete barrier may be considered. See the Design Memorandum in the Roadway Design website for the use of very low speed approach barrier and the detail contained in the Roadway Plan Details.

The use of W-beam guardrail buried in backslope as an end treatment is not desirable and should not be considered.

### **305.11 - Barriers at Bridge Ends**

The unprotected end of a bridge is considered a fixed object. For single bridges a length of approach barrier that satisfies length of need and terminates with a crashworthy end treatment is provided for each approach end within the recovery area.

For twin bridges, the length of the approach barrier on the median side of each bridge should be of sufficient length to shield the median end of the other bridge if within the recovery area. A chain link cable barrier fence, as shown in the ADOT Construction Standard Drawings, should be used as an additional backup system to the barrier length of need where traffic, flowing watercourse, or non-traversable slope exists in the median between the bridges.

## **306 - Typical Cross Sections**

### **306.1 - General**

ADOT has developed highway cross sections for the typical rural, urban, and fringe-urban conditions expected throughout the State. Absent special conditions, these typical sections should be used for highway design.

The typical cross sections are described in the following paragraphs and are illustrated in the accompanying figures. The typical cross sections were developed for typical conditions and engineering judgement must be used in applying these cross sections to a particular project or situation.

The roadway dimensions should be considered fixed as shown in the cross sections. **Any changes to these dimensions must have the approval of the Assistant State Engineer, Roadway Engineering Group.**

Where the side slopes shown in the cross sections reference the Construction Standard Drawings, the slope criteria in the standard drawings should be followed except where right-of-way, economics, safety, or other considerations justify a different slope. For urban

highways with outside curbs, the side slopes should be as flat as reasonable within economic and right-of-way constraints.

The right-of-way widths shown in the cross sections should be provided wherever reasonable. At any location, the right-of-way should provide for the traveled way, the shoulders, any median, the side slopes and slope rounding, and a clearance to right-of-way line. As described elsewhere, many of these dimensions may be safely adjusted to avoid expensive right-of-way takes.

The typical cross sections, as presented, can be readily modified to meet future needs as traffic demands increase, and as rural areas become fringe-urban and fringe-urban areas transition into full urban conditions.

### 306.2 - Rural Cross Sections

The recommended typical sections for rural highways are shown in [Figure 306.2](#).

The areas where the rural cross sections should be used are characterized by open public lands or private lands with very sparse development; very limited and generally minor side access requirements; away from populated areas; and, reasonably not subject to development. Highways in these areas will have higher operating, posted, and design speeds. The highways will be uncurbed except as required for drainage and embankment erosion control.

A) *Section RA*: This section is required where the design year DHV exceeds 800 vph and should be considered where the DHV is above 500 vph (see below). The section is applicable to both controlled and non-controlled-access highways.

This section is often used to improve the capacity of an existing two-lane highway. Where the terrain and other conditions are favorable, the existing roadway should be used as one direction of travel and combined with a new one-directional roadway to form the first stage of an RA section. A later stage of construction would replace the existing roadway to form the ultimate RA section. In such cases, **the initial design for the first stage project shall address the ultimate constructed project as well as the first stage.**

When the design year DHV exceeds 500 vph, the need for a four-lane typical section should be fully investigated. If the four-lane section is not warranted at the time the current project is to be constructed, all project development through initial design should be completed for the full staged development of an RA section roadway. This includes environmental coverage for the fully developed project, and, where possible and/or necessary to protect for future staged development, should include purchase of the full right-of-way corridor.

The slope hinge point should be set a distance of six times the pavement structural section thickness but no less than 9 ft from the outer edge of the shoulder. (See Slope Hinge Detail on [Figure 303.1](#) for additional information and exceptions.)

In addition to satisfying drainage requirements, the bottom of cut ditch should be located a minimum of 20 ft from the edge of shoulder.

Side slopes for Section RA should meet the requirements of Construction Standard Drawing C-02.10.

The median slopes for the RA Section should desirably be 6:1 with 4:1 being the minimum acceptable. Median design requires consideration of both these slope requirements and the drainage requirements discussed in Chapter 600.

A distance between roadway centerlines of 108 ft is desirable. The minimum median width is 50 ft as shown for the RA Section in [Figure 306.2](#). For an access-controlled highway, the 50 ft median section will provide for a future 12 ft lane and median shoulders in each direction with a concrete median barrier. Determination of the median separation requires consideration of right-of-way, drainage and minimum side slopes, roadway aesthetics, and horizontal and vertical geometry. **The initial design for the four-lane section shall include a concept, including typical sections, for the future widening.**

The RA Section in [Figure 306.2](#) showing the absolute minimum 16 ft median width with a concrete median barrier is applicable for two lanes in each direction only when a third median lane is not a future consideration.

*B) Section RB:* This section should be used when the design year DHV is between 200 vph and 800 vph. (For DHV greater than 500 vph, see the discussion of RA Section above.)

The nominal shoulder wedge slope should be 6:1 with the fill slope hinge point at least 9 ft from the shoulder edge (see [Figure 303.1](#)). In addition to satisfying drainage requirements, the bottom of ditches should be located at least 15 ft from the edge of shoulder.

The side slopes should meet the requirements of Construction Standard Drawing C-02.20.

*C) Section RC:* This section may be used on State routes and miscellaneous roads when the design year DHV is less than 200 vph. **The use of Section RC requires the concurrence of the Assistant State Engineer, Roadway Engineering Group.**

The nominal shoulder wedge slope should be 4:1 with the fill slope hinge point at least 6 ft from the shoulder edge (see Construction Std. Drawing C-02.30). In addition to satisfying drainage requirements, the bottom of ditch should be located at least 8 ft from the edge of shoulder.

The side slopes should meet the requirements of Construction Standard Drawing C-02.30.

*D) Non-standard sections:* From time-to-time, non-standard highway cross-sections may be developed for application on very low volume, low speed connecting roads, where the roadway functions as a collector or local facility, and where there is not a large proportion of heavy vehicles.

**The non-standard roadway section can be used on a limited basis and is subject to the approval of the Assistant State Engineer, Roadway Engineering Group.**

The non-standard roadway section applies to roadways having volumes under 100 vph and may consist of lane widths of 10-12 ft and non-curbed shoulder widths of 2-4 ft with the upper end of each range being the desirable width. The shoulder wedge slope, hinge point location, ditch width, and cut and fill slopes should meet the minimum requirements of Construction Standard Drawing C-02.30.

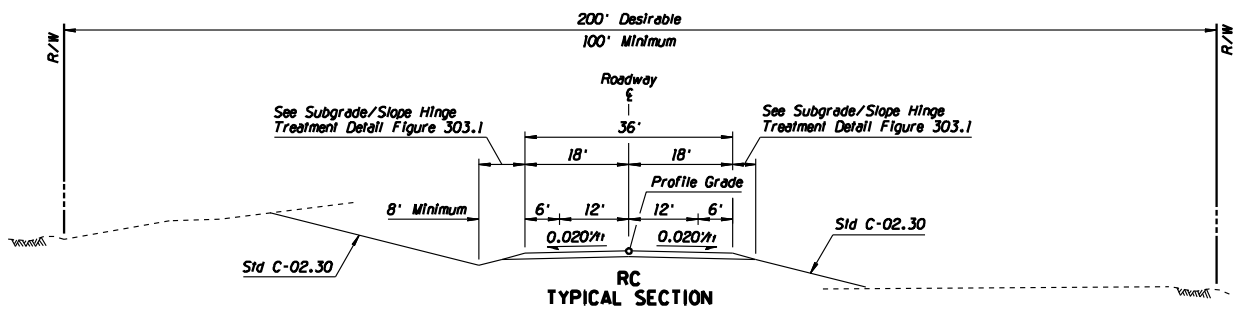
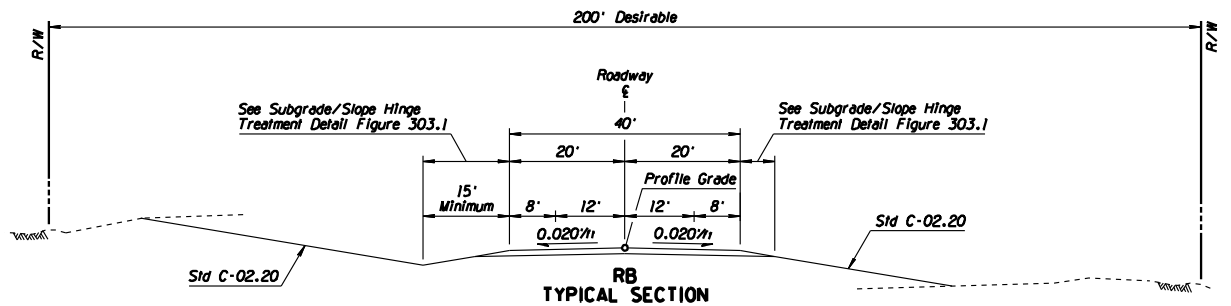
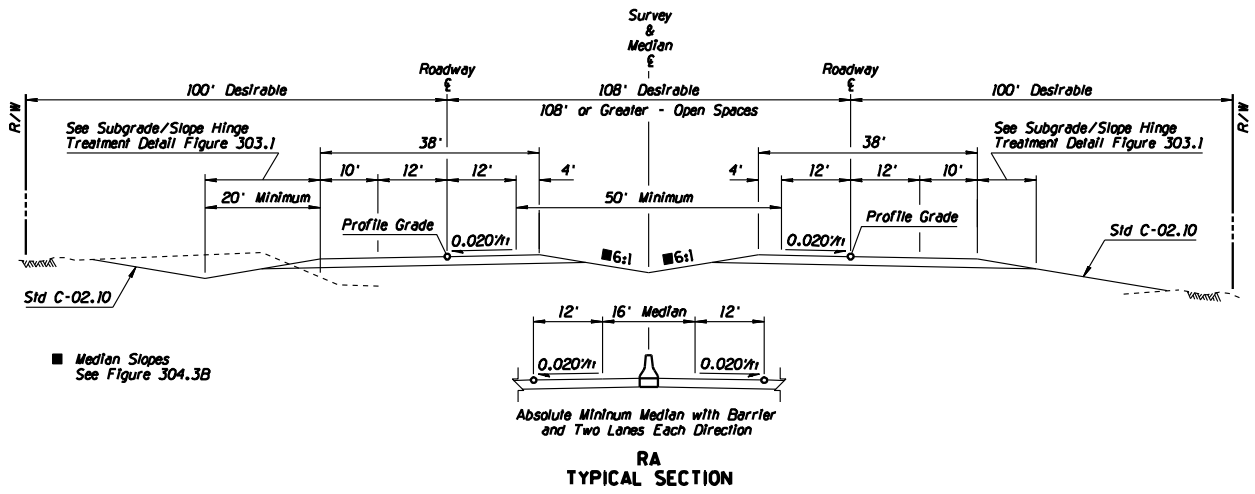

**RURAL HIGHWAY  
 TYPICAL SECTIONS  
 FIGURE 306.2**

### 306.3 - Fringe-Urban Cross Sections

The fringe-urban cross sections shown in [Figure 306.3](#) are applicable to highways in those areas which do not meet the definitions of urban or rural area. Generally, the fringe-urban areas could be classified as suburban or emerging areas. In such areas, there is a reasonable expectation that the area would undergo some level of urbanization within the 20-year design projection period of highway projects. In a fringe-urban area, there is light to moderate general development with sparse commercial or other major traffic generating development. The fringe-urban areas are generally proximate to a city or town.

Highways in the fringe-urban areas have higher operating and posted speeds than in an urban area, but there is an expectation that both will decline during the 20-year design period of the highway. Generally, there is no curb with initial construction; however, curbs may be needed in the future.

The fringe-urban sections have been developed to meet the requirements of near-rural conditions of initial construction and to readily accommodate an ultimate conversion to urbanized conditions.

Compared to the rural and urban cross sections, the intermediate cross sections will provide better service to the traveling public through areas of moderate to low development. The sections can be more conveniently converted to the urban sections with curb, gutter, sidewalks and signals than can the rural sections described above. These intermediate sections maximize control of side access and discourage strip development without construction of frontage roads, purchase of access rights, or adoption of local zoning ordinances stipulating access limitations.

Selection of a cross section for a fringe-urban area should recognize the probable length of time between initial construction and the need for conversion to an urban section. Short-term conversion would anticipate a need for an urban section ([Figure 306.4A](#)) in five to ten years after initial construction. A long-term conversion would be more than ten years after initial construction.

The recommended typical sections shown in [Figure 306.3](#) are for fringe-urban highways where short-term conversions are anticipated.

Typical Sections RA and RB in [Figure 306.2](#) should be used for long-term conversion situations in fringe-urban areas giving full consideration to staged construction and incorporation of the existing roadway. The maximum median width for Section RA in this situation is 50 ft. When using Section RB in this situation, special attention must be given to the potential for the urbanization of adjacent areas, particularly when proximate to other developed areas. In such cases, it may be appropriate to plan the new highway for ultimate staged construction to a divided section.

A) *Short-term conversion Section IS1:* This is the preferred section for fringe-urban areas where the design speed is 55 mph or less.

The divided roadway section with a curbed median can be readily converted to the UA Section ([Figure 306.4A](#)) by saw-cutting the excess width paving and constructing a curb and gutter at the outer edge of the roadway.

The nominal outside shoulder wedge slope should be 6:1 with the fill slope hinge point at least 9 ft from the shoulder edge (see [Figure 303.1](#)). In addition to satisfying drainage requirements, the bottom of ditches should be located at least 15 ft from the edge of the shoulder.

Side slopes for the IS1 Section should meet the requirements of Construction Standard Drawing C-02.20.

The typical 16 ft curbed median will provide for a full 12 ft left-turn lane plus a 4 ft nose area for placing traffic control devices. The median curb is offset 4 ft from the edge of the adjacent traffic lane to provide additional "shy distance". The offset will continue through intersections, i.e., the left-turn lane will be offset 4 ft from the adjacent traffic lane.

A) *Short-term conversion Section IS2:* This flush-median section may be used only where a divided roadway (Section IS1) is not practical and feasible, or where the current level of strip development has progressed to the point where a divided roadway could not be readily implemented.

This section can be converted to the UB Section by saw-cutting and removing the excess width paving and constructing curb and gutter at the outer edge of the roadway. A median barrier is not required; the paved median may be used as a left-turn lane.

The nominal outside shoulder wedge slope should be 6:1 with the fill slope hinge point at least 9 ft from the shoulder edge (see [Figure 303.1](#)). In addition to satisfying drainage requirements, the bottom of ditches should be located at least 15 ft from the edge of the shoulder.

Side slopes for the IS2 Section should meet the requirements of Construction Standard Drawing C-02.20.

B) *Short-term conversion Section IS3:* The divided roadway section with an uncurbed, unpaved median should be used where a divided roadway is practical and feasible, and where the design speed is normally 50 mph or greater.

The median width for Section IS3 is 46 ft. **The initial design for the four-lane section shall include a concept, including normal and superelevated typical sections, for a future widening.** The future widening could provide a two or three lane section with a raised median. **With the approval of the Assistant State Engineer, Roadway Engineering Group, the median width may be reduced.** Consideration should be given to utilization of a 48 ft median for future conversion to Section IS1.

Median barriers are required as outlined in [Section 304.4](#).

The nominal shoulder wedge slope should be 6:1 with the fill slope hinge point at least 9 ft from the shoulder edge (see [Figure 303.1](#)). In addition to satisfying drainage requirements, the bottom of the cut ditch should be located at least 15 ft from the edge of shoulder.

Side slopes for the IS3 Section should meet the requirements of Construction Standard Drawing C-02.20.

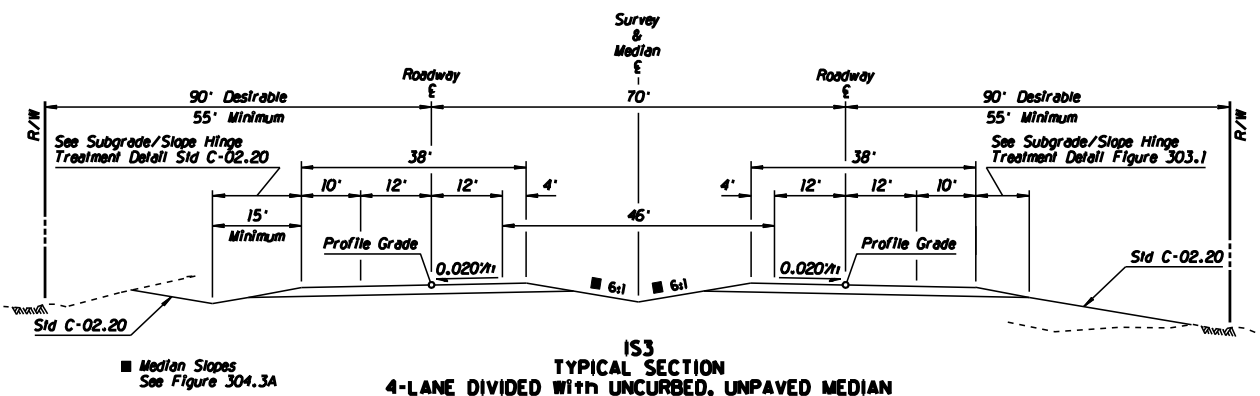
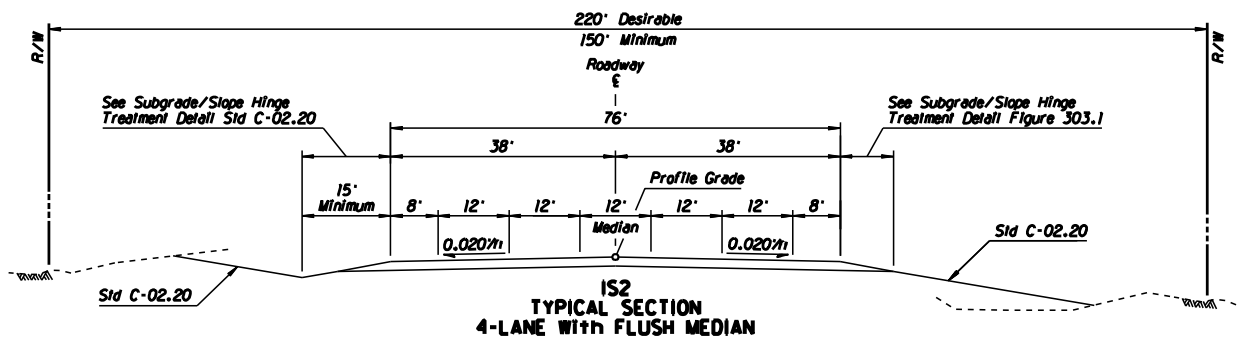
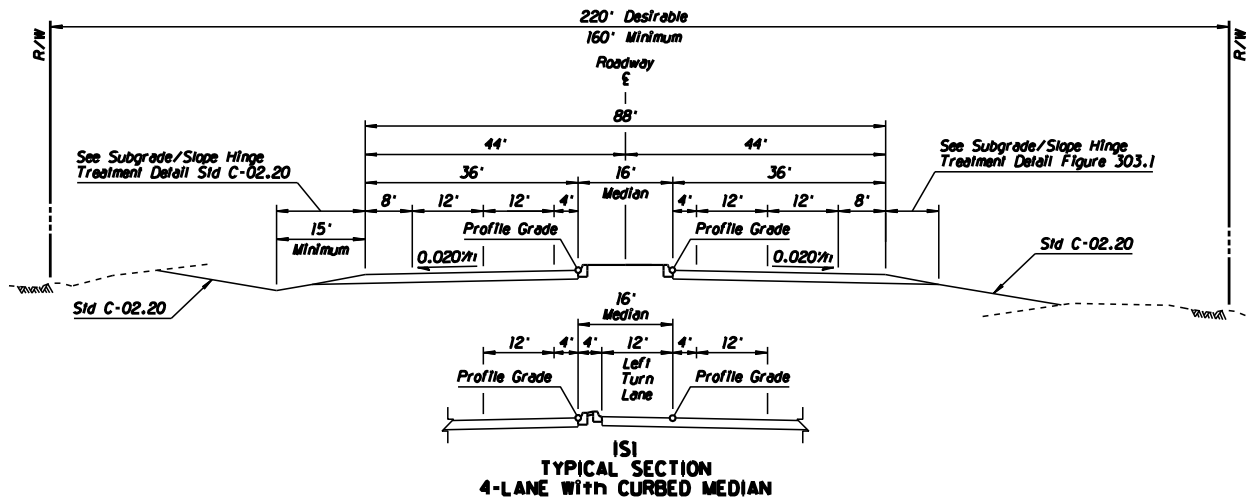

**FRINGE-URBAN HIGHWAY**  
**TYPICAL SECTIONS**  
**FIGURE 306.3**

### 306.4 - Urban Cross Sections

The recommended typical sections for urban highways are shown in [Figures 306.4A-B](#).

The areas where the urban cross sections should be used are characterized by reasonably continuous current development, or expectations of such within five years, and a high density of side access points. The urban sections normally are used within a city or town.

The desirable and minimum widths for right-of-way shown in [Figure 306.4A](#) are necessarily subject to increase as required by drainage needs or terrain. However, where the existing right-of-way is less than the minimum shown, additional right-of-way should be obtained only as required to accommodate the construction. Additional right-of-way may be required at intersections to provide for additional turning lanes.

*A) Urban Section UA:* This section should be used on highways for the initial construction to four lanes. This section is normally used as the urban extension of a divided rural or fringe-urban highway. Use of this section should be based, in part, on a consideration of the access requirements of adjacent properties. The section may not be appropriate for areas of heavy strip development. On a project-by-project basis, a 15 ft outside lane, exclusive of curb and gutter, may be considered to accommodate bicycle usage. Factors to be considered include location, vehicular traffic, grades, anticipated bicycle usage, and right-of-way availability.

The side slopes for this section are not covered by the Construction Standard Drawings. The side slopes should be as flat as practical with the given right-of-way constraints. Sidewalks, when required, should be offset from the roadway to the extent practical as shown in [Figure 306.4C](#). Desirably, there should be at least 5 ft between the sidewalk and the back of the roadway curb. It is rarely appropriate to acquire additional right-of-way solely for setting the sidewalk away from the roadway. When the right-of-way is limited and the desirable setback distance to the sidewalk cannot be achieved, the sidewalk should be placed adjacent to the roadway curb.

The location of the sidewalk should be coordinated with the local government and with the Roadside Development Section when the highway project involves landscaping.

See [Figure 306.4A](#) for typical applications of slopes. See [Figure 306.4C](#) for additional applications of slopes adjacent to sidewalk locations.

*B) Urban Section UB:* This section should be used where an existing four-lane undivided highway is being widened or where existing strip development requires the continuous two-way left-turn lane. On a project-by-project basis, a 15 ft outside lane, exclusive of curb and gutter, may be considered to accommodate bicycle usage when weighing the factors listed in Section UA.

See the above discussion of Section UA for treatment of sidewalks, side slopes and ditches.

C) *Urban Section UC*: This section has limited usage and is applicable only in small urban areas with low traffic volumes. This section would be the final upgrading where volumes do not warrant four lanes.

The nominal slope for the shoulder wedge should be 6:1 and ditch bottoms should be at least 8 ft from the edge of shoulder.

D) *Urban Section UD*: This section is to be used for the urban portions of controlled-access highways. [Figure 306.4B](#) shows the ultimate facility with four lanes in each direction and the interim facility with three lanes in each direction. Normal crown sections are shown in each of the figures.

It is important that the initially constructed roadways can be readily and economically modified in the future to the ultimate cross-section. Ideally, the vertical alignments of the roadways will provide a common elevation at the future median barrier as shown in [Figure 306.4B](#). However, a "saw-tooth" typical section (See [Figure 304.3C](#)) may be preferable considering the overall project costs. In the scoping process for each project, the ultimate condition profile grades for the two roadways should be established first; the interim cross section should then be developed from the ultimate condition.

The Construction Standard Drawings do not govern the side slopes for this section. Side slopes should be as flat as practical with the given right-of-way constraints. Cut slopes should be a maximum of 3:1 and fill slopes should be 4:1 or flatter.

See [Section 304.3](#) for information on the treatment of urban controlled access highway medians.

**E) *Non-Standard Sections*: The following sections can be utilized on a very limited and restricted basis, subject to specific prior approval of the Assistant State Engineer, Roadway Engineering Group. The approval is required prior to development of the Final Project Assessment or Final Design Concept Report.**

Included are:

- ◆ Three lanes. Use of a three-lane section is restricted to local traffic or non-through routes; i.e., routes with little or no external through traffic, which have very restrictive existing right-of-way. Further, the section is limited to application in small urban areas, and where implementation will constitute final, ultimate construction. The roadway will be 44 ft wide with two 12-ft through lanes, a 12-ft turn lane, and 4-ft non-curbed shoulders on each side. With curb and gutter, a 14 ft wide outside lane exclusive of curb and gutter is acceptable to accommodate bicycle traffic.

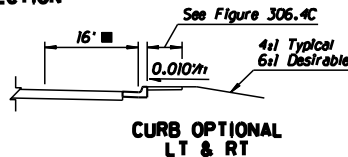
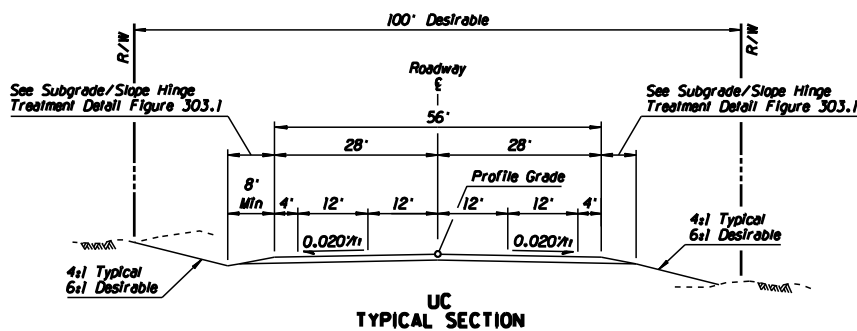
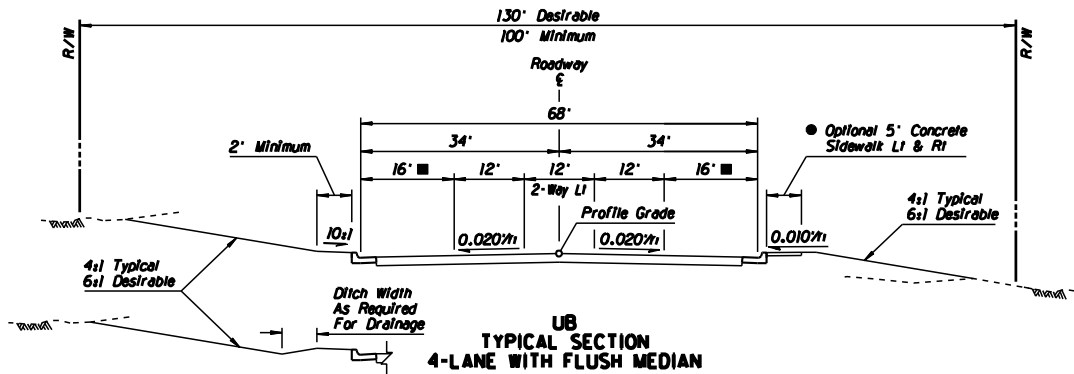
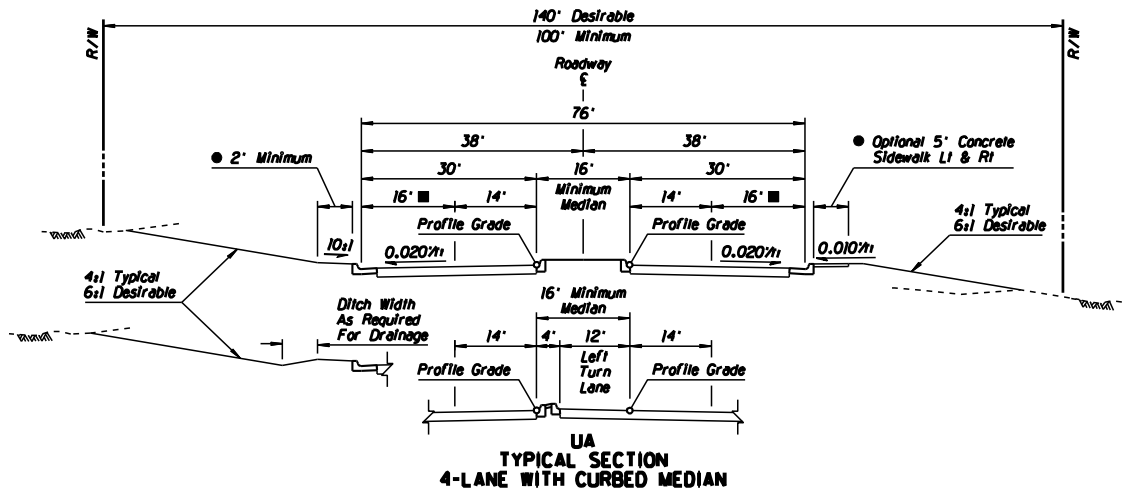

- For Sidewalk Locations See Figure 306.4C Provide Space for Future Sidewalk, if Applicable
- Consider 17 ft on a project-by-project basis to accommodate bicyclists. Consider factors such as location, vehicular traffic, grades, anticipated bicycle usage and right of way availability.

## URBAN HIGHWAY TYPICAL SECTIONS FIGURE 306.4A

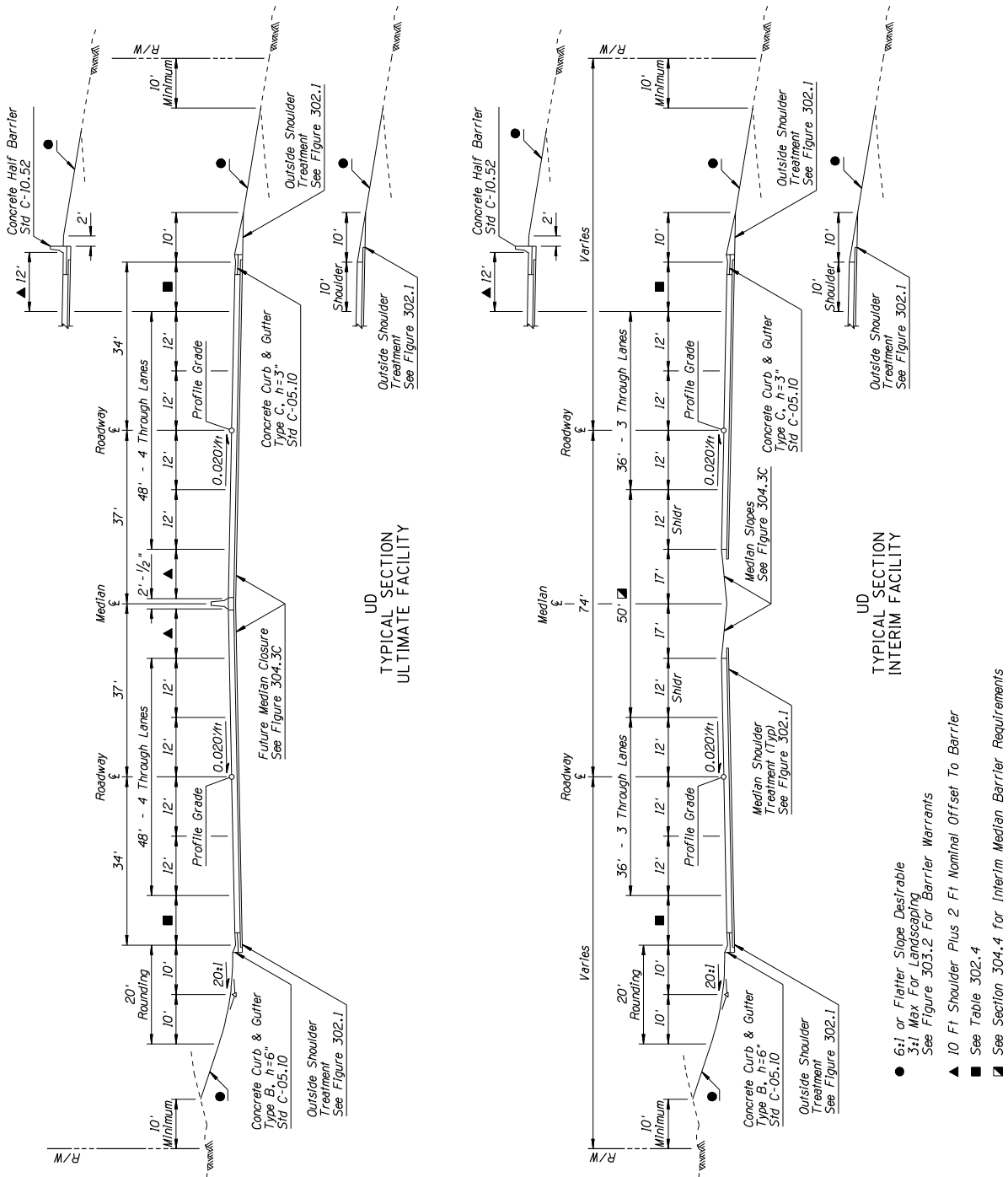

**CONTROLLED ACCESS  
URBAN HIGHWAY  
TYPICAL SECTIONS  
FIGURE 306.4B**

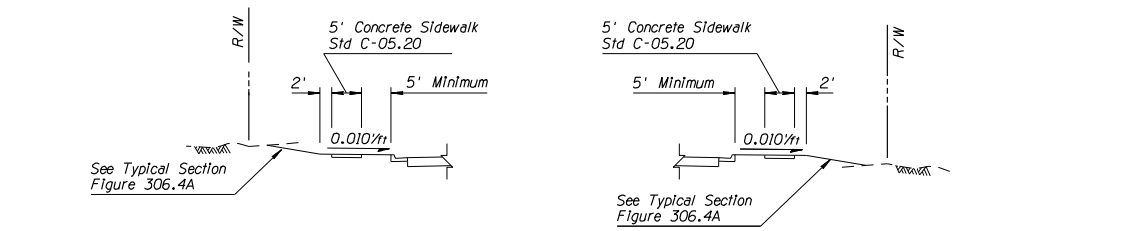

DESIRABLE SIDEWALK LOCATION

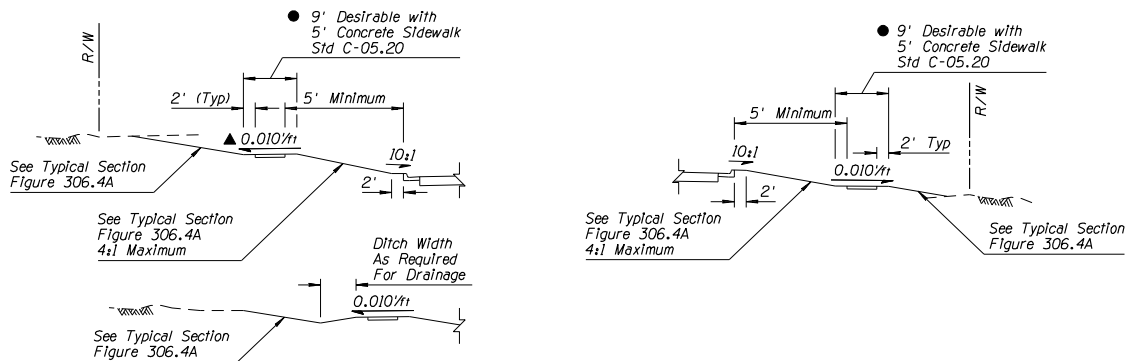

OPTIONAL SIDEWALK LOCATION

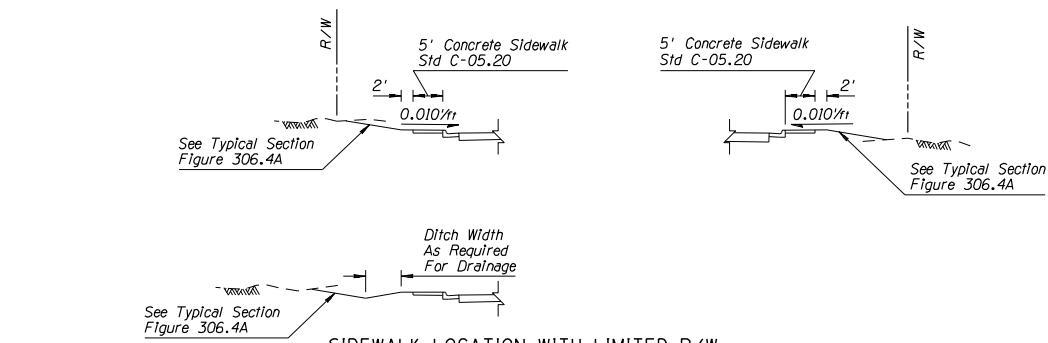

SIDEWALK LOCATION WITH LIMITED R/W

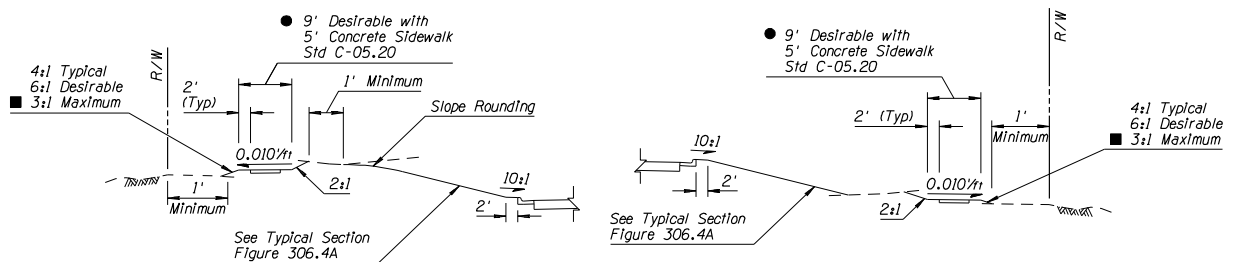

INDEPENDENT SIDEWALK LOCATION

■ Fill Slopes Steeper Than 3:1 May Require Railing for Pedestrian Safety

▲ Sidewalk Slope Direction Optional Per Design

● Vertical and Horizontal Control Lines, On the Outside Edge of the Sidewalk, Are Developed and Shown on the Plans, If Applicable.

## URBAN HIGHWAY SIDEWALK LOCATIONS FIGURE 306.4C

### **306.5 - State Funding Exclusions**

No on-street parking will be constructed at State expense. When approved by the State Transportation Board, parking may be added by joint project agreement, with the outside agency fully funding incremental construction, right-of-way, and utility relocation costs.

Except at the immediate approaches to traffic interchanges with State routes, six-lane sections will not be constructed at State expense to complement or supplement a local jurisdiction's internal street transportation network. When approved by the State Transportation Board, six-lane sections may be added by joint project agreement, with the outside agency fully funding incremental right-of-way and utility relocations costs, and equally sharing the incremental cost of construction.

### **306.6 - Cross Sections for Other Agencies**

When a State highway project requires reconstruction of another agency's roadway, the local agency's typical cross sections should be followed subject to the exclusions given above in [Section 306.5](#) and in [Chapter 100](#). See the "ADOT Bicycle Policy" for the accommodation of bicycle traffic for local agency roads.

## **307 - Right-Of-Way**

The right-of-way widths for highways should be adequate to provide for all cross-sectional elements including medians, traffic lanes, shoulders, recovery areas, slopes, slope treatments, walls, ramps, lighting, signals, drainage, maintenance activities and other essential parts of the facility including future requirements. Construction and maintenance requirements outside the permanent right-of-way should be accommodated by providing temporary easements. Minimum clearances from the right-of-way line to the catch point of a cut or fill slope are given in [Section 303.6](#).

Desirable and minimum widths of right-of-way are given with the drawings of the recommended typical sections.

The right-of-way acquired for a project need not be a constant width but should reflect the requirements of the project and the configuration of the land parcels to be acquired. In some circumstances, it may not be prudent to acquire even the minimum right-of-way shown. **Providing less than the recommended minimum right-of-way will require the approval of the Assistant State Engineer, Roadway Engineering Group.**

Right-of-way requirements should be coordinated with the Right-of-Way Group. Discussions with Right-of-Way staff should include the cost and time to acquire necessary parcels.

### **308 - Horizontal/Lateral Clearances**

Lateral clearances are to be provided to major structures along the roadway including abutments, piers, columns and walls. It is desirable to set lateral clearances for new structural elements at a distance equal to the clear zone or greater. In many instances lateral clearances meeting clear zone widths cannot be provided and therefore must be protected with an appropriate barrier system. AASHTO provides guidelines for recommended horizontal clearances to structures, tunnels, bridge barriers, sign supports, walls, longitudinal barriers and curbs. The corresponding minimum horizontal clearances (not clear zone) of the AASHTO "Policy on Geometric Design of Highways and Streets" should be met.

See [Section 303.2](#) for clear zone determination.

See Roadway Design Memorandum entitled "[2-Foot Offset Distance to Roadside Barriers](#)" on the Roadway Design website.

### **309 - Frontage Roads**

The general policy on frontage roads is discussed in Section 104.3. Frontage roads, outside of the ramp areas, are generally returned to the control of the local jurisdiction for maintenance and operation.

Refer to [Figures 309A](#) and [309B](#) respectively for one-way and two-way Frontage Road Typical Sections. Roadway widths, slope treatments, right-of-way requirements and separation distances from mainline traffic are shown in the Figures. Standard lane widths are 12 ft. Minimum shoulder widths are as shown and are also included in [Table 302.4](#).

The desirable separation between the outside main roadway lane and near frontage road lane is 40 ft for one-way frontage roads and 50 ft for two-way frontage roads. The minimum separation that may be considered for a one-way frontage road without barrier is equal to the clear zone requirement for the mainline traffic. The need for a separation barrier should be evaluated considering barrier warrant criteria, access control, traffic and other factors along the frontage road such as intersection locations and controls.

The designer should also address the need for special treatments at the T-intersections providing access to the frontage road. Channelization of the T-intersection should be considered using raised islands and striping to discourage a vehicle from running the intersection and into mainline traffic. Barrier located in the separation area may be considered. Factors such as volume and usage of the access driveway, separation area width and character should be considered.

The highway side of the frontage road traveled way should be at least 10 ft from the highway right-of-way line. The minimum right-of-way width for frontage roads should be 50 ft outside the highway right-of-way line.

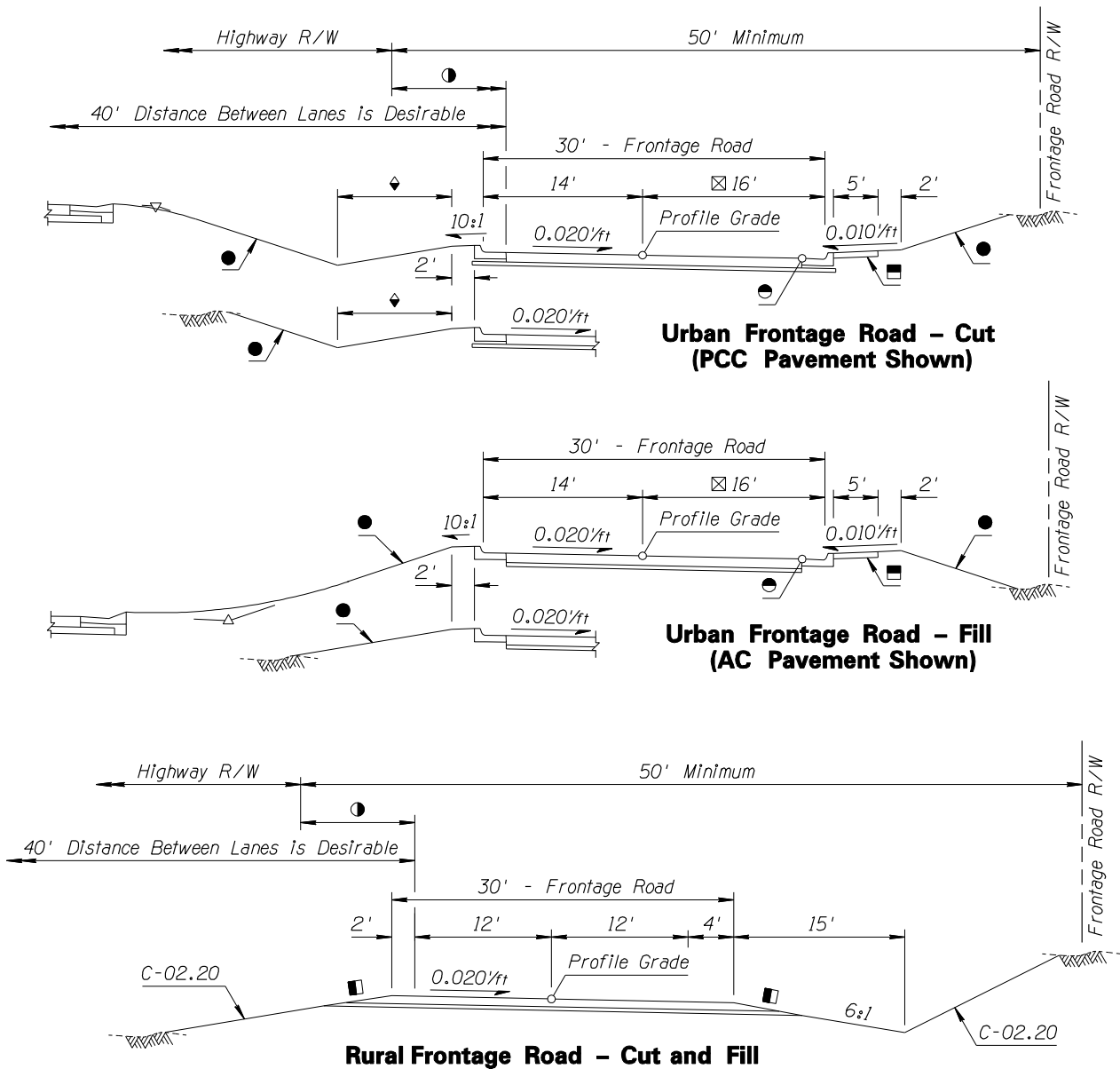

- ◆ Ditch Width As Required For Drainage
- Optional New 5' Concrete Sidewalk  
Std C-05-20  
Offset Sidewalk Is Desirable  
See Figure 306.4B
- 6:1 or Flatter Slope Desirable  
3:1 Maximum For Landscaping
- ⊠ 17' Where Frontage Road Serves Commercial  
Business on Outside (R/W Side)
- 10' Minimum to Frontage Road Lane
- Optional Gutter Control Grade (Typ)

- See Figure 302.1 for PCC Pavement Urban  
Shoulder Treatments
- See Figure 303.1 for AC Pavement Shoulder  
Wedge Detail

**ONE-WAY FRONTAGE ROAD  
TYPICAL SECTIONS  
AND SLOPE TREATMENTS  
FIGURE 309A**

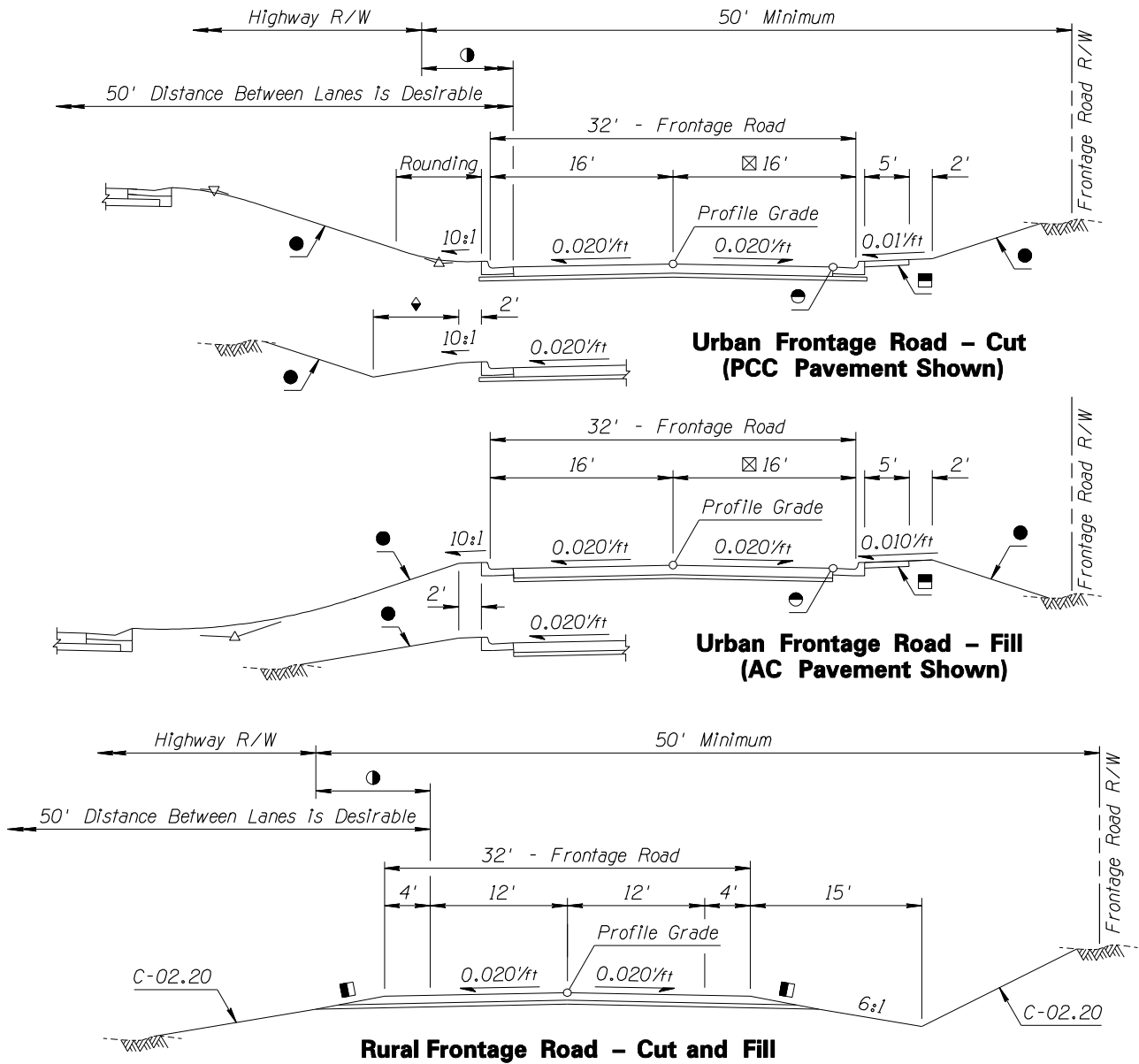

- ◆ Ditch Width As Required For Drainage
- Optional New 5' Concrete Sidewalk  
Std C-05-20  
Offset Sidewalk Is Desirable  
See Figure 306.4B
- 6:1 or Flatter Slope Desirable  
3:1 Maximum For Landscaping
- ⊠ 17' Where Frontage Road Serves Commercial  
Business on Outside (R/W Side)
- 10' Minimum to Frontage Road Lane
- Optional Gutter Control Grade (Typ)

See Figure 302.1 for PCC Pavement Urban  
Shoulder Treatments

■ See Figure 303.1 for AC Pavement Shoulder  
Wedge Detail

**TWO-WAY FRONTAGE ROAD  
TYPICAL SECTIONS  
AND SLOPE TREATMENTS  
FIGURE 309B**

### **310 - Sidewalks and Sidewalk Ramps**

The policy on providing sidewalks is discussed in [Section 107.2](#). Typical details for sidewalks and sidewalk ramps are shown in the Construction Standard Drawings. Normally, sidewalks are 5 ft wide unless local standards require a greater width. Preferably, sidewalks are set back from the roadway curb and gutter to the extent practical and at least 5 ft from back of curb to sidewalk. If right-of-way constraints do not permit a setback, the sidewalk will be adjacent to the curb and gutter except at driveways where the sidewalk is constructed at the back of the driveway slope with appropriate transitions to the normal sidewalk. The project plans should detail where aggregate base is to be placed under sidewalk and driveways when warranted by local soil conditions.

Sidewalk ramps are to be provided where required to accommodate pedestrian changes in elevation, primarily at curb crossings or curb and gutter. **Sidewalk ramps shall conform to the requirements of the Americans With Disabilities Act (ADA) of 1990 and current updates.** Current ADA requirements provide for the inclusion of tactile detectable warnings on sidewalk ramps to alert the visually impaired as to the ramp terminus location. See [Section 107.3](#).

The AASHTO “Guide for the Planning, Design, and Operation of Pedestrian Facilities” contains additional design guidance that may be utilized for sidewalks and sidewalk ramps.

### **311 - Earth Retaining Structures**

#### **311.1 - General**

Earth retaining walls should be considered whenever the normal fill or cut slopes extend beyond acceptable limits. Retaining walls are classified according to the manner in which they retain the earth:

- ◆ gravity walls use the weight of the wall to resist the overturning forces of the earth;
- ◆ cantilever walls use the bending resistance of a thin wall supported on a footing to retain the earth;
- ◆ mechanically stabilized walls are mechanically integrated with the earth to form a stable mass to resist the overturning forces; and
- ◆ pile walls retain the earth through the bending strength of piles embedded in the earth.

Walls may also be classified according to the type of analysis required by the wall designer and how the walls are specified in the plans and special provisions: Standard Designs, Special Designs, Pre-approved Proprietary Designs and Experimental Designs. The ADOT Retaining Wall Policy provides guidelines for use of retaining walls.

Designs and plans for standard design walls are available in Structure Standard Details. These walls require no structural analysis; however, assumptions regarding loading conditions and foundation requirements on which these standard designs are based should be verified by structural engineers. Designs and plans for walls which do not meet the design assumptions for standard walls should be made by structural engineers.

A list of pre-approved wall systems is maintained by Contracts and Specifications Section. Pre-approval does not mean that a wall system is suitable for a particular site. It is the responsibility of the Bridge Group to verify that a proprietary wall system is acceptable in a particular site and situation.

When proprietary wall systems are to be specified, the special provisions will specify the pre-approved systems which are acceptable for the particular application and site. All design parameters and site specific details including requirements for such appurtenant features as utility openings, drainage features and anchorages for traffic and/or pedestrian rails, traffic poles, sound walls, safety shape barriers, guardrails and fences must be incorporated in the plans or special provisions. Architectural treatments for the finished wall surface may be a consideration in environmentally sensitive areas.

Generally, the highway designer will determine the need for earth retaining structures to meet the requirements of the highway project. Retaining structures are most often warranted by economic comparisons with the costs of excavation or embankment, right-of-way or bridge structures.

The highway designer is responsible for establishing a profile along the top of the retaining structure, the soil profile along the front face of the structure, and the length of the structure. The highway designer should also identify the acceptable limits of excavation required to maintain traffic and to design any required detours.

The highway designer should coordinate with Bridge Group early in the planning process to permit time to obtain geotechnical information on the structure site.

The appropriate types of retaining structure are determined by Bridge Design Section in conjunction with the highway designer. To promote competitive bidding all appropriate wall systems should be included in the contract plans.

Safety railings should be placed with retaining walls where landscaping or routine maintenance activities can be expected adjacent to the walls. This is for the protection of maintenance workers where walls are greater than 4 ft high in accordance with OSHA regulations. The height of the top rail must be 42 in. above the top of the wall whether the railing is mounted on or adjacent to the wall. The paint color of the railing should be coordinated with Roadside Development Section and the local government when applicable.

### **312 - Noise Barriers**

Increased traffic volumes due to new highway construction or expansion of existing roadways will result in increased noise levels. Nearby residents/customers will notice these increases. ADOT's Noise Abatement Policy considers noise abatement measures when noise thresholds are exceeded and implements noise abatement measures where reasonable and feasible.

ADOT uses federally approved computer models for predicting sound levels in decibels at selected roadside points, and include such modeling parameters as traffic characteristics, highway land configuration, and distance from the noise source. Environmental Planning Group will assess the reasonability and feasibility of noise mitigation for residents/customers.

ADOT typically abates noise by constructing barrier walls or earthen berms to break the line of sight between traffic and residents/customers. The height, length, and placement of the barrier or berm is based on results from the traffic noise model. Access openings in noise barrier walls for utilities or drainage must be coordinated with Environmental Planning Group. Highway designers and project managers should coordinate with Environmental Planning Group early in the project design phase.

### **313 - Right-of-Way Fence**

Fencing is provided along the ADOT right-of-way to physically identify the right-of-way and to impede unauthorized access onto the right-of-way.

**All controlled access highways shall have right-of-way fencing except where walls or other physical barriers adequately define the right-of-way or where public access to the highway is permitted.**

Non-controlled access highways in rural areas should be fenced. In fringe-urban areas, highways should be fenced unless access to adjacent properties is so frequent that only short runs of fencing could be provided.

In urban areas, those State highways which also function as arterial streets (Urban Sections UA, UB, and UC -- see [Section 306.4](#)) generally should not be fenced since access to the adjacent properties may be expected to be provided at frequent intervals along the highway.

The Construction Standard Drawings include the standard types of fences generally used by ADOT. The types of fencing to be included in the plans is dependent upon a number of factors and the selection should involve representatives of the District, the Right-of-Way Group, and the Environmental Planning Group.

## **314 - Miscellaneous**

### **314.1 - Cattle Guards**

Cattle guards, with or without gates, may be required to prevent livestock from interfering with roadway traffic or to maintain range control. To prevent cattle from entering the right-of-way, the construction of cattle guards may be required at side roads and private entrances. When placed near traffic interchanges on a crossroad, cattle guards without gates should be placed at or near the access control line to prevent livestock entering the main roadway. Only under unusual circumstances will cattle guards be justified in urban areas. The number of units required should be determined by the width of the roadway. See [Roadway Plans Details](#) on the Roadway Design website for cattle guards.

### **314.2 - Right-of-Way Markers**

Right-of-way markers are placed to delineate the new right-of-way line and to facilitate re-establishment of the centerline. Markers are placed in accordance with [ADOT R/W Plans Section R/W Monumentation Procedures and Standards](#). Markers are ordinarily placed at all new right of way corners, i.e. , at the intersections of new right of way lines and surveyed section lines, mid-section lines, and subdivision boundaries; and on the new right of way lines opposite Station Equations of the centerline(s) controlling the new right of way lines.

Right-of-way markers are shown symbolically on the roadway plans. The right-of-way plans show the station and centerline offset to the marker locations.

### **314.3 - Survey Monuments**

Permanent survey monuments should be placed at all section corners and one-quarter corners when such corners fall within the roadway section. See the Construction Standard Drawings for monument details.

## **315 - Temporary Connections**

There are often differences between the typical cross sections and the design standards of an existing highway and a section of new construction along the same alignment. Care must be taken to avoid abrupt changes between the two sections. Temporary connections can be used to affect an orderly transition of design speeds as well as cross-sections. If the difference between the design speeds of the new construction and the existing highway, including cross-sectional constraints, exceeds 10 mph, horizontal curves should be introduced in the temporary connection to assist the driver in recognizing and adapting to the lesser design standards. See [Sections 106.3](#) and [316](#) for additional discussion.

## **316 - Detours**

### **316.1 - General**

For other than short-term use, detours should be paved with appropriate pavement striping, signing, traffic barriers, lighting, signalization and sidewalks. Roadway designers should coordinate with Materials Group for the pavement section and with Traffic Engineering Group for temporary striping, signing, temporary concrete barriers, lighting, and signalization plans.

### **316.2 - Traffic Lanes and Shoulder Width**

In general, the number of traffic lanes on the detour should be the same as the existing roadway. Lane widths should not be less than those on the approach roadway but may require reduction where detour traffic crosses existing narrow structures.

For rural divided highways, it is often appropriate to use one roadway as a two-way detour by reducing traffic in each direction to one lane and constructing detour connections across the median. In evaluating such a detour, consideration should be given to traffic volumes and the duration of the detour.

In urban areas, the number of lanes may be reduced if a capacity analysis shows that the level of service will not be less in the reduced section than at adjacent controls such as intersections.

**Shoulder Width:** the width of shoulder utilized for detours is dependant upon several factors which should be weighed to determine the width selected for a particular location. These factors include detour location, traffic volume and composition, shoulder width of existing roadway, posted speed for detour, profile and side slopes, bicycle and pedestrian usage, need for longitudinal barrier, detour length, and duration of service. The designer should weigh all of the above factors in determining the selected shoulder width for the detour.

*Undivided highways:* the minimum detour shoulder width for a two-lane two-directional detour on a rural undivided highway is 2 ft. When bicycle traffic is prevalent, a minimum 4 ft shoulder should be provided. When the shoulder width of the approach roadway is greater than 4 ft, the existing shoulder width may be carried through the detour but may be reduced to no less than 4 ft after consideration is given to the factors listed above. Where longitudinal barriers are required, an additional 2 ft offset to face of barrier should be provided.

A one-lane rural detour will normally have a left shoulder of 2 ft and a right shoulder of 8 ft, however, the right shoulder may be reduced to 6 ft or 4 ft when conditions are favorable based upon the factors previously listed. Detour shoulder widths for urban arterial highways will generally follow the cross-section of the approach roadway.

*Divided highways:* detours for four-lane divided highways normally have a one-lane detour to the other roadway. The detour cross section should be that of a ramp typical section having a 2 ft left shoulder and an 8 ft right shoulder. If longitudinal barriers are required along the detour, they should be offset an additional 2 ft to the face of barrier. Multi-lane detours should provide an 8 ft right shoulder and a 4 ft left shoulder.

To accommodate larger design trucks using detours having sharper horizontal curvature, turning paths should be checked to determine if there is a need to provide additional shoulder widening. Additional pavement width may also be needed to accommodate placement of temporary concrete barrier.

### **316.3 - Design Speed**

A) Rural detours: The desirable design speed of a rural detour should be 55 mph for controlled-access highways and four-lane (or more) divided highways. For other rural highways, detours should be designed for 45 mph.

The design speed at the entrance of a detour may be 10 mph less than the existing posted speed by utilizing a speed reduction on the main roadway prior to the detour.

The initial curve of a detour should be designed for the speed determined previously for the entrance. Intermediate curves may be designed for a speed 10 mph less than the initial curve but should not be less than the design speed for the remainder of the detour.

In areas with restrictions (i.e., topography, structures, right-of-way, etc.), the detour design speed may be reduced an additional 10 mph with the concurrence of Traffic Engineering Group.

B) Urban detours: The design speed at the detour entrance should not be less than the normal posted speed of the existing roadway. The design speed for the remainder of the detour and any subsequent detours within the construction project may be up to 20 mph less than the preconstruction posted speed.

Particularly in urban areas, the physical conditions at the detour site may constrain the geometric layout of the detour such that lower design speeds may be required. In such cases, the roadway designer should coordinate with the Traffic Engineering Group to assure that temporary speed reduction signs are provided in advance of the detour. Such physical constraints may include locations of existing buildings, masts for overhead power, etc. (Permanent right-of-way limits are a design consideration, but not necessarily a constraint.)

### 316.4 - Horizontal Alignment

**Except as noted below, the horizontal alignment of a detour shall comply with the criteria given in [Chapter 200](#) of this Manual.**

Detours should be placed on the side of the construction which will minimize conflict between the traveling public and the construction work. The alignment should provide a minimum clear distance of 12 ft between the construction and the edge of detour pavement. Greater minimum distances may be required for certain types of construction as described below. The District construction staff should be consulted regarding the appropriate clear distance prior to designing the detour.

The horizontal alignment of a detour will normally be comprised of a detour entrance curve (or taper) to shift traffic off of the existing roadway, a combination of horizontal curves and tangents to provide the requisite clearance to the construction activity and a detour exit curve (or taper) to bring traffic back to the existing roadway.

Entrance curves should extend from the normal roadway section to a point where the full width of the detour has been developed outside the normal roadway. On rural detours, the radius of the entrance curve should be from the appropriate [Tables 202.3B-D](#) using the superelevation of the existing roadway lane with consideration of any adverse existing superelevation. Similarly, for urban detours, the initial curve minimum radius should be from the appropriate [Tables 202.3A-D](#).

The design approach to the detour exit curve should be similar to the entrance curve.

When tapered detour entrance and exits are used, the taper rate should be in the ratio of posted speed to one.

The horizontal curves provided for detours should be such that spirals are not required.

Where the existing roadway horizontal alignment is curved at the entrance or exit of a detour, a horizontal curve should be used on the inside of the roadway curve to provide the transition to the full width of the detour. A tangent alignment may be used for the transition on the outside of the roadway curve. The length of the transition (tangent or curve) should be the same as would be provided by the entrance curve on a tangent roadway alignment.

The detour geometry will, in part, be determined by the construction which is being bypassed. For structures, an embankment cone should be provided to accommodate the bridge abutment. As shown in [Figure 316.4](#), the embankment cone should provide a minimum clear distance of 10 ft between the end of the wingwall and the top of the cone. Temporary slopes of the embankment cone are assumed to be a maximum of 2:1. The distance between the toe of the embankment cone slope and the detour should be a minimum of 12 ft and desirably 30 ft.

Where the bridge is being built essentially on existing grade, at least 22 ft and desirably 40 ft should be provided between the detour and the bridge elements. The excavation location, depth and slopes plus the construction work area requirements should be considered in determining the detour layout.

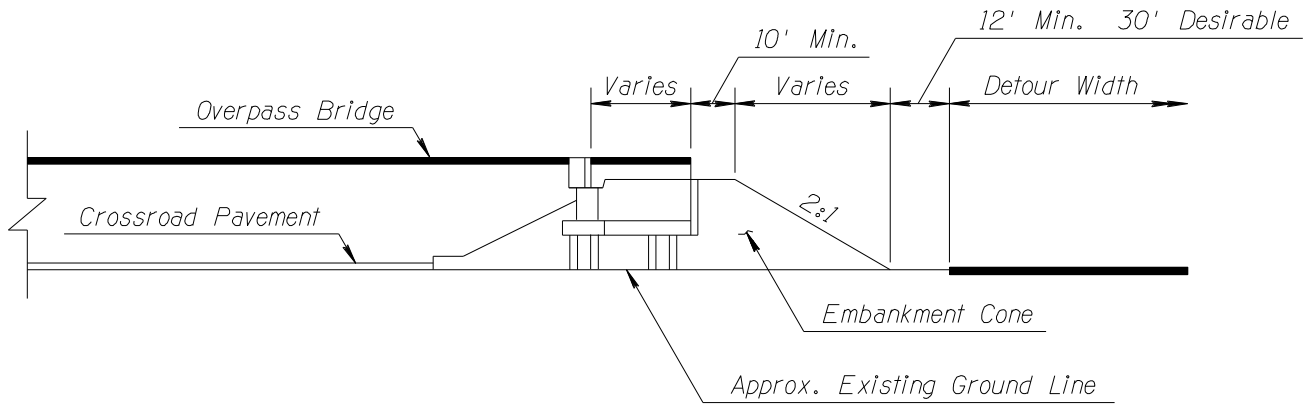

**Embankment Condition**

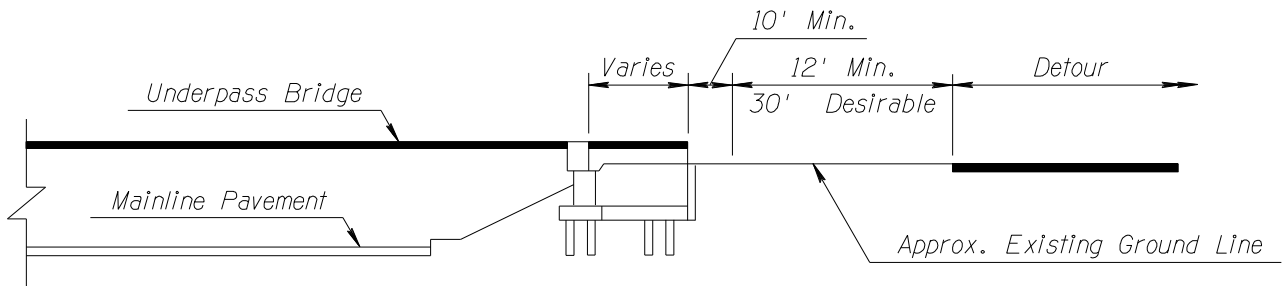

**Depressed Condition**

**DETOUR CLEARANCES AT BRIDGES**  
**FIGURE 316.4**

### **316.5 - Superelevation**

Superelevation should be provided for rural detour horizontal curves using [Tables 202.3B-D](#). The appropriate table should be based on the climatic conditions expected throughout the life of the detour.

Superelevation for urban detours should be as given in [Tables 202.3A-D](#).

Adequate tangent distance between successive horizontal curves should be provided to accommodate superelevation runoff.

In constrained conditions, the absolute minimum rates of transition given in [Chapter 200](#) are applicable.

### **316.6 - Vertical Alignment**

Detour profiles should consider existing ground conditions to avoid drainage problems and difficult transitions to existing roadway grades. Detour profiles should permit detour grades and superelevation to be run out smoothly and match those of the existing roadway and should avoid adverse superelevation on the outer lanes(s) of the entering and exiting curves.

The detour profile should be carried along the horizontal control line of the detour.

**Adequate stopping sight distance shall be provided.**

### **316.7 - Drainage**

The area between the detour and the construction work should be swaled or graded to convey minor runoff.

Detour plans should include any temporary drainage facilities required to control and dispose of stormwater collecting at the detour site. In designing temporary drainage facilities, the designer should evaluate detour closure, local street drainage patterns, possible damage to the detour site and/or surrounding areas, potential for construction delays, removal of temporary facilities, and costs. See Chapter 600 for additional discussion regarding drainage for detours.

Detours generally have three low points (at the low side of superelevated sections) requiring drainage consideration. The plans should include provisions for properly draining these locations. Interruption of existing drainage flows by the detour should be investigated and dealt with accordingly. Temporary concrete barriers used along the edge of pavement should have drainage scuppers to pass surface runoff and avoid excessive pavement ponding.

### 316.8 - Other Features

- ◆ *Temporary Barriers:* In rural areas, temporary barrier protection should be provided in accordance with [Section 303.2](#) - Roadside Recovery Area.

The constrained site conditions and tighter horizontal geometry for urban area detours may require temporary barrier protection along both sides of detours.

- ◆ *Sidewalks:* An asphaltic concrete sidewalk should be placed along the edge of the detour where sidewalks exist or where significant pedestrian activity occurs along the detoured roadway. The detour sidewalk width should match the existing sidewalk width. A minimum sidewalk width of 4 ft may be considered in very restricted locations, however, a 5 ft minimum wide passing area shall be provided at 200 ft intervals. **Temporary barrier shall separate the sidewalk from the traffic lanes.**
- ◆ *Temporary Lighting:* Temporary lighting may be required at detour locations. The extent of temporary lighting needs should be determined on an individual basis with consideration of traffic volumes, turning movements, access to property, pedestrian activity, safety hazards, etc. The roadway designer should consult with the Electrical Design Section of Traffic Engineering Group for assistance in determining the need for temporary lighting on detours.

The responsibility for the design, installation, and maintenance of lighting facilities varies among local jurisdictions.

For detours on local streets, the local government should be contacted early in the design process to determine who will be responsible for furnishing lighting materials and their installation, operation and maintenance while the detour is in effect. The Traffic Engineering Group can assist in this determination. The responsibilities must be clearly identified in the contract documents. If a local government is responsible for a part of the temporary lighting, an Intergovernmental Agreement is required.

- ◆ *Signing and Marking:* The detour must be properly signed and marked. The roadway designer must coordinate with the Traffic Engineering Group early in the design process to assure complete compatibility between detour geometry, signing and marking.
- ◆ *Local Access:* The roadway designer should review access to existing businesses or residences as they are affected by detours or construction activities. Special signing may be necessary to direct traffic to businesses where the normal access points have been disrupted or altered.



## **CHAPTER 400**

### **AT-GRADE INTERSECTIONS**

#### **401 - Introduction**

There are three categories of roadway intersections: at-grade, grade separated (i.e., without ramps), and interchanges.

Interchanges are discussed in Chapter 500 of this document. Grade separated intersections are covered under the provisions of Chapter 200.

This chapter covers at-grade intersections--the area where two or more roads join or cross at the same elevation including the roadside facilities for moving traffic within it. For convenience, when used in this document, the term "intersection" refers to at-grade intersections.

Integral to the definition of an intersection is the concept of connectivity; i.e., the roadways not only intersect, they are connected. A driver is able to go from one roadway to another, to change direction.

Interchange ramps and high-speed entrances and exits are covered in Chapter 500 – Traffic Interchanges. This Chapter 400 covers low-speed (up to 45 mph) turning roadways with their entrances and exits plus the low-speed termini of high-speed ramps.

#### **402 - Design Considerations**

##### **402.1 - General**

Proper intersection design is important because the efficiency, safety, capacity, cost of operation and operating speed of a highway are determined by its intersections.

Intersections must accommodate the interests of its users--buses, motor vehicles, trucks, pedestrians and bicycles. Arriving, departing, merging, turning, and crossing paths for these users have to be accommodated within a relatively small area.

The main objective of intersection design is the reduction of the severity of these conflicts while accommodating the natural transitional paths and operating characteristics of the users consistent with the constraints of the site.

The design of an intersection is best done as a cooperative effort between highway and traffic engineers. Early involvement of the Traffic Engineering Group in the analysis and design of projects with intersections is essential.

## 402.2 - Design Elements

Four basic elements must be considered in the design of an at-grade intersection:

A) *Human factors*: The assumption of certain driver skills is inherent in the design of an intersection. Driver's perception and reaction time set the requirements for sight distance and transition lengths. The driver's ability to evaluate a situation and make decisions affects signing and marking as well as sight distance. Drivers expect and somewhat anticipate geometric and operational conditions at intersections. They tend to assume that the intersection will conform to expected paths of movement.

Pedestrians and bicyclists must be considered in the design of an intersection because of their potential conflict with motor vehicles. Factors such as volumes, age, and physical abilities are essential to define the magnitude of their impact.

B) *Traffic*: The size and shape of an intersection are based upon the characteristics of the traffic which it must accommodate. The design volume and variety of desired movements will determine the number and orientation of the traffic lanes and the lengths of storage lanes. The size and operating characteristics of expected vehicles will determine the lengths of storage lanes, lane widths, and turning roadway radii and widths as well as the widths of acceleration and deceleration lanes. Vehicle speeds impact sight distances, signalization, taper rates and turning radii.

Additional impacts come from transit and bicycle traffic -- generally due to the need for bus stop pullouts, rapid transit stations, bicycle lanes or shared roadways.

C) *Site Characteristics*: Human factors and traffic considerations generally produce desires or demands for certain design elements in an intersection. The site characteristics often impose constraints that limit the designer's ability to meet these demands.

Intersection site characteristics include the character and use of the abutting properties, vertical alignments, horizontal alignments, the number of intersecting roadways and their angles of intersection.

D) *Economic Factors*: As with any transportation project, cost is a major consideration in the design of intersections. The primary costs are the construction of the intersection and the acquisition of rights-of-way required for the intersection itself and for controlling or restricting access from abutting properties.

## **403 - Intersection Types**

### **403.1 - Basic Types of Intersections**

The basic types of road intersections are shown in [Figure 403.1](#). Certain of the types shown have been marked "DO NOT USE" to indicate they are unacceptable or undesirable.

The type of intersection is generally determined by the number of intersecting roadway legs. However, operationally, the four-leg and three-leg intersections are the preferred types. Multi-directional "Y" intersections are unacceptable and every effort should be made to avoid intersections with more than four legs. For example, at a five-leg intersection, one leg may be combined with another leg sufficiently outside of the intersection such that the main intersection's operation is not impaired.

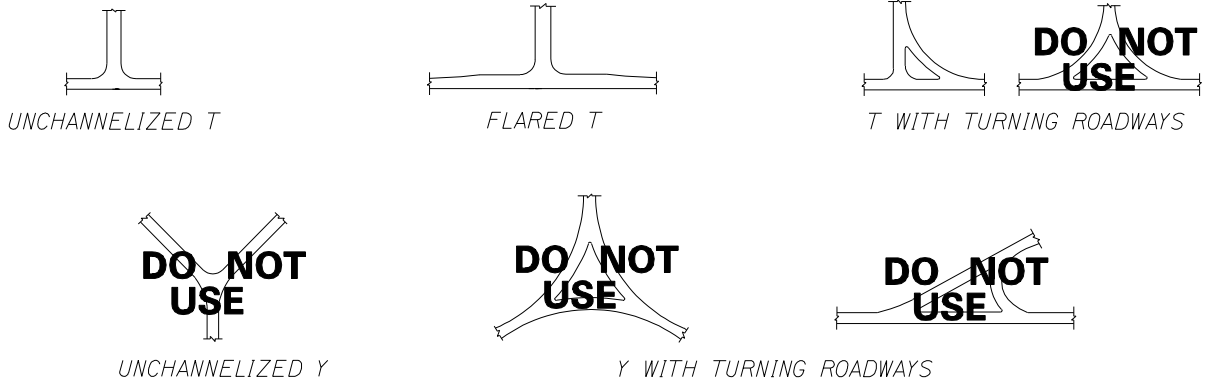

**3 - LEG INTERSECTIONS**

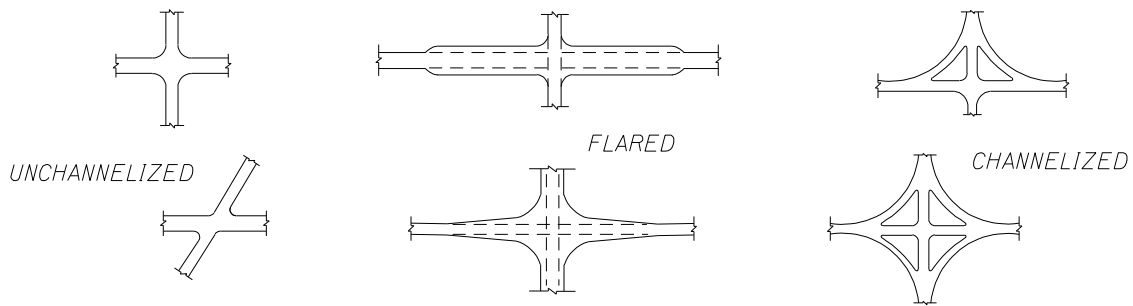

**4 - LEG INTERSECTIONS**



**MULTILEG INTERSECTION**

**ROTARY INTERSECTION**

(See Section 403.2)

**BASIC TYPES OF AT-GRADE INTERSECTIONS**

**FIGURE 403.1**

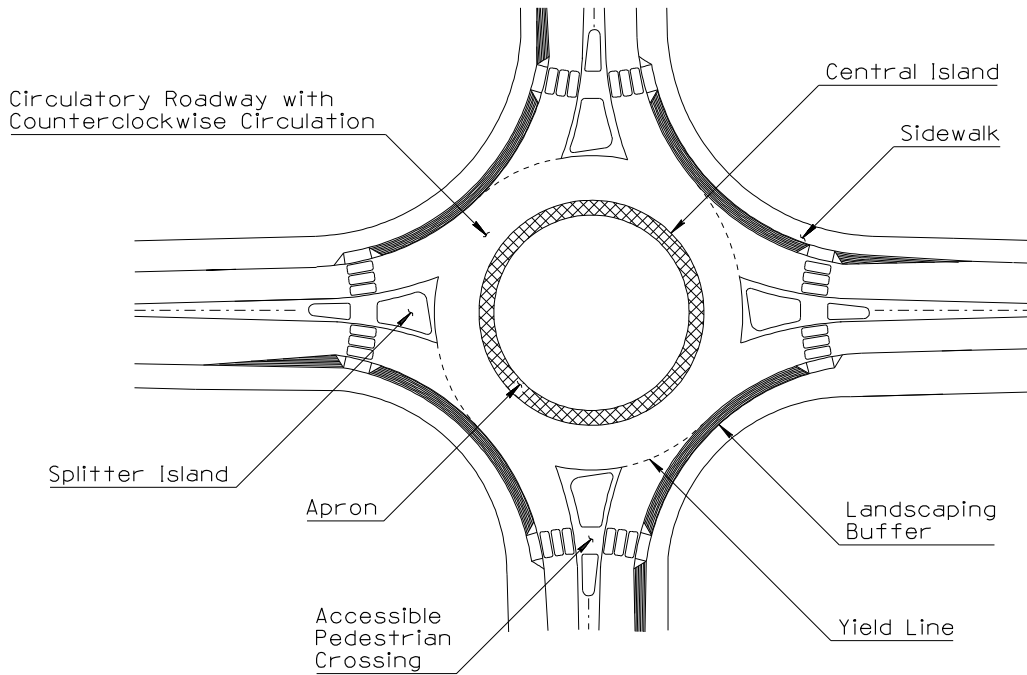

**KEY ROUNDABOUT FEATURES**

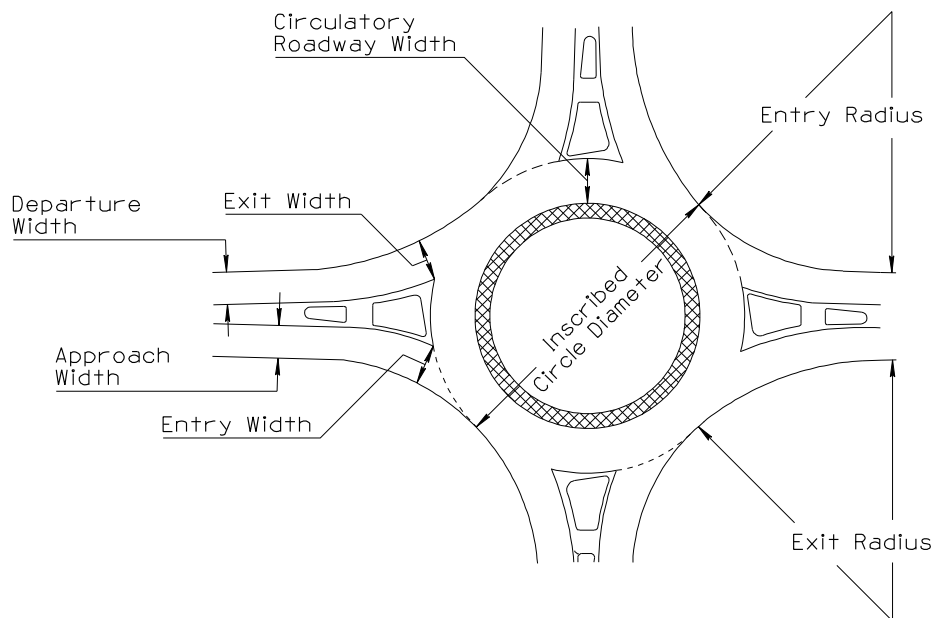

**KEY ROUNDABOUT DIMENSIONS**

**MODERN ROUNDABOUT  
FIGURE 403.2**

### 403.2 – Modern Roundabouts

A modern roundabout is a one-way circular intersection having specific design control features, including slow speed, that clearly distinguish it from the older large diameter traffic circles, rotaries or small diameter traffic calming circles utilized on residential streets. [Figure 403.2](#) shows basic layout of modern roundabouts with key features and dimensions.

The older traffic circles and rotaries fell out of favor in the 1950's due to safety and operational problems encountered as traffic volumes increased beyond operational limits. Significant progress has been made in the design of circular intersections. The modern roundabout may look similar but should not be considered the reincarnation of the traffic circles of the past.

A modern roundabout is defined by three basic principles that distinguish it from a traffic circle:

1. **Yield at Entry:** Vehicles approaching the circular intersection must wait for a gap or yield to traffic in the roundabout.
2. **Traffic Deflection:** Traffic entering the roundabout is directed or channeled to the right with an appropriate curved path into the circulating roadway that avoids the central island.
3. **Geometric Curvature:** The radius of the circular road and the angles of entry can be designed to slow the speed of vehicles. Key geometric design parameters and the fastest speed path are critical to achieve proper design.

Modern roundabouts may be considered as viable alternatives to other intersection types. This is not to imply that modern roundabouts are a solution for all intersections but that they may be considered along with other intersection designs. Modern roundabouts can greatly improve the operation of multi-leg and heavily skewed intersections. The objective is to improve the design and operation of the intersection. When modern roundabouts are compared to signalized intersections, the roundabout may offer a reduction in overall delay and congestion, increase capacity and improve safety. Studies have shown that when stop sign and signal control intersections are converted to modern roundabouts, significant reductions in crash severities and percentage of injury crashes have occurred. Fatal and incapacitating injuries have also been reduced significantly, primarily due to elimination of right-angle crashes and reduction in speed. The numbers of accidents, although lower in severity, may increase until drivers achieve a comfort level with the roundabout.

Cost considerations for the usage of roundabouts include the elimination of signals and power, and reduced accident costs. The cost of right-of-way, possible need for illumination, and central-island landscaping all contribute to the life cycle cost of a modern roundabout when comparing alternative intersections. Environmentally, fewer vehicle starts and stops will reduce air pollution.

## Design of Roundabouts

### **General:**

Good design of modern roundabouts requires a level of expertise ranging from a basic level for the design of single lane roundabouts having average daily traffic of less than 1500 vehicles per hour entering the intersection to more challenging designs of higher complexity involving higher volumes, increased number of lanes, more intersection legs, and increased physical space requirements. Early and continued close coordination is required between designers responsible for geometrics, signing and striping of a modern roundabout. The goal in designing the geometry of a modern roundabout is to balance the needs for safety, capacity, operational performance and right-of-way constraints to serve all users including cars, pedestrians, bicycles and large trucks. The roundabout operates safest when entering and circulating traffic is forced to operate at low speeds through the use of a small inscribed circle diameter and low-speed entry geometry. Geometric parameters for modern roundabouts are controlled by the turning paths of the largest vehicles anticipated to utilize the intersection. Design “principles” are employed in the design of roundabouts rather than hard rules due to the varying range of complexity.

Any 4-way stop intersection that is being considered for new construction or reconstruction may qualify for evaluation as a modern roundabout. There are no specific warrants for when to construct a modern roundabout, however there are certain geometric design requirements that would have to be met before a modern roundabout can be considered and include:

- a) Maximum grade of 4% for any leg; and
- b) Sufficient stopping sight distance prior to the entrances.

In addition to the tenets above, there are a number of locations and site conditions that often present complications for installing modern roundabouts. Extra care should be exercised when considering roundabouts at the following locations:

- Intersections in close proximity to a signalized intersection where queues may spill back into the roundabout;
- Intersections located within a coordinated arterial signal system;
- Intersections with a heavy flow of through traffic on the major street opposed by relatively light traffic on the minor street;
- Intersections having physical complications or topography that limits visibility; and
- Intersections with heavy bicycle or pedestrian volumes.

Modern roundabouts may be advantageous over other traffic control at the following locations and conditions:

- Intersections with historical safety problems;
- Intersections with relatively balanced traffic volumes;
- Intersections with high traffic volumes during peak hours but relatively low traffic volumes during non-peak hours;
- Existing two-way stop-controlled intersections with high side-street delays (particularly those that do not meet signal warrants);
- Intersections that accommodate a high number of left turns or U-turns;
- Locations where the speed environment of the road changes (for instance, at the fringe of an urban environment);
- At a gateway or entry point to a commercial development, neighborhood, or campus (such as at bridge approaches);
- Intersections where traffic growth is expected to be high and future traffic patterns are uncertain;
- Locations with a need to provide a transition between land use environments (such as between residential and commercial uses); and
- Roads with a historical problem of excessive speeds.

### **Landscaping:**

Landscaping the central island, splitter islands (where appropriate), and the approaches can benefit both public safety and enhance the visual quality of the intersection and the community. Effective landscaping treatments can only be achieved through close coordination between the roadway designers, landscape designers and maintenance personnel. The landscaping of roundabouts and their approaches should:

- Make the central island more conspicuous;
- Improve the aesthetics of the area while complementing surrounding streetscapes as much as possible;
- Minimize introduction of fixed objects such as trees, poles, walls, guardrail, statues, or large rocks close to the perimeter portion of the central island;

- Avoid monuments, statues, artwork, benches, small text and advertising that may encourage pedestrians to enter the central island;
- Avoid obscuring the form of the roundabout or the signing to the driver;
- Clearly indicate to drivers that they cannot pass straight through the roundabout;
- Maintain proper intersection sight distance through the perimeter of the central island and the entrances at the splitter islands;
- Discourage pedestrian traffic through the central island;
- Help blind and visually impaired pedestrians locate sidewalks and crosswalks; and
- Provide landscaping designs with full consideration for maintenance needs and accessibility.

Additional discussion and design guidance on landscaping treatments for roundabouts is contained in the first two design references listed below.

**Design References:**

This manual (RDG) does not provide detailed design guidelines. Applicable design guidelines and reference materials are:

1. Facilities Development Manual, State of Wisconsin, Chapter 11 Section 26.
2. NCHRP Report 672 Roundabouts: An Informational Guide.
3. "Roundabout Design Guidelines" by Ourston Roundabout Engineering, March 2001. These guidelines provide good information including some design guidelines for applications not included in references 1 and 2.

Design Software:

**The RODEL software model for roundabout intersection analysis shall be utilized for all modern roundabouts on the State highway system.**

**Design Review:**

The proper design and review of modern roundabouts requires an acquired level of expertise relative to the complexity of the design. This expertise is acquired by experience in designing and in evaluating the operational characteristics of existing modern roundabouts. Expertise is available from several resources. The design team should consider the complexity of the modern roundabout and determine whether outside expertise should be brought in to review the proposed design. Guidance on the selection of the level of expertise needed by the reviewer based upon the complexity of the modern roundabout is contained in the Wisconsin Manual (Ref. #1 above). Design review should be accomplished at the earliest time practical after the initial layouts are available.

Supporting information required for review of roundabout designs includes:

- Engineering design data needed to utilize RODEL;
- The design plans (plan and profile) including surface drainage concept;
- A comparison of the roundabout design to alternative intersection types explaining why the roundabout is the preferred alternative including economic considerations;
- A traffic analysis of alternative intersection types including a discussion on level of service and delay impacts. Discuss any adverse impacts of the roundabout, impacts on the corridor, all potential complicating factors including constructability, their relevance to the location, and any mitigation efforts that may be required;
- A discussion on pedestrian and bicycle traffic; and
- The calculated design speeds for the entry path, the circulating path, the exit path, the left-turn path and the right-turn path for each leg of the roundabout.

### **403.3 - Channelized Intersections**

Channelization is used where traffic volume, intersection area, intersection angle, and movement complexity, singly or in combination, warrant expansion of the design beyond the minimum.

Channelization separates or regulates conflicting traffic movements into definite paths of travel by using traffic islands, pavement markings, or other suitable means to facilitate safe and orderly traffic flow. Channelization is applicable to two-lane highways but reaches its highest degree of development and is most generally used for multi-lane divided conditions. Only intersection quadrants warranting separate turning lanes, speed change lanes, or other features should be channelized.

#### **403.4 – Skewed Intersections**

Whenever possible, intersecting roads should meet at or nearly at right angles for reasons of safety and operational efficiency. Roads intersecting at acute angles require larger areas for turning movements and tend to limit visibility. In addition, skewed intersections limit the ability of drivers (particularly older drivers) to adequately turn their heads to view traffic and to negotiate the turning movements. Vehicles require longer time to turn or cross a skewed angle intersection. These impacts become more significant with divided highway intersections.

Intersection angles that are skewed more than 15 degrees from a right angle are undesirable and should be avoided to the extent practical: the minor leg should be realigned if warranted by traffic and economic considerations.

**Skewed intersections, including driveways and turnouts, having angles exceeding 20 degrees from a right angle shall require the approval of the Assistant State Engineer, Roadway Engineering Group.**

#### **404 - Driveway and Turnout Access**

##### **404.1 - General**

Driveways and turnouts provide access to property abutting the State highway. The number of turnout locations should be kept to a minimum to enhance capacity and safety of the through roadway. The access from a curbed highway is a driveway; access from an uncurbed highway is called a turnout. Throughout this section, the term "turnout" should be construed to include "driveway" as well.

Generally, existing "permitted" and "prior-rights" turnouts will be replaced when highways are reconstructed provided design considerations can be met. Where design conditions cannot be satisfied, the turnout permit may be revoked by the District and prior-rights for turnout access may be acquired. Turnouts which do not have permits or prior rights should not be replaced as a part of a reconstruction project.

Where highways are on new alignment, new turnouts may be provided for abutting property owners under the permitting process and in accordance with the requirements of this chapter. See Section 104 for additional discussion on this topic.

General criteria for locating and dimensioning rural and urban turnout access to State highways are shown in the Construction Standard Drawings. These criteria should be used except that local regulations governing driveway construction may be followed if they would require a higher standard.

Turnouts should be perpendicular to the highway. Depressed curb openings are provided for driveways. Turning radii should be used where the highway does not have curb and gutter.

Turnouts for high volume traffic generators require a Traffic Impact Study and are approved individually by Traffic Engineering Group or the Regional Traffic Engineer.

Where multiple turnouts are under consideration, consolidation of access points should be examined. A shared access between adjacent properties will require agreements between the property owners.

On frontage roads and in rural areas where the maximum legal vehicle must be accommodated, truck-turning templates should be used to check turnout radii and widths. This is particularly important where the curb or edge of traveled way is so close to the right-of-way line that a usable connection cannot be provided within the standard limits. Depressed curb widths may need to be widened to accommodate vehicles such as RVs that require extra width.

NCHRP Report 659 "Guide for the Geometric Design of Driveways" provides additional information in addressing driveway design issues.

#### **404.2 - Driveway and Turnout Types**

A) *Residential* - one providing access to a single-family residence, to a duplex, or to an apartment building containing five or fewer dwelling units.

B) *Commercial* - one providing access to an office, retail or institutional building or to an apartment building having more than five dwelling units. Certain urban commercial driveways may need to accommodate the maximum legal vehicle.

C) *Industrial* - one directly serving a substantial number of truck movements to and from loading docks of an industrial facility, warehouse or truck terminal.

D) *Joint Use* - one that serves two parcels of land. The joint use turnout is desirable whenever feasible. If the property line is not normal to the right-of-way line, care should be taken in designing the joint opening so that both owners are adequately served. Both owners must consent to the joint use turnout in a signed written agreement.

#### **404.3 - Driveway and Turnout Grades**

A) *Rural turnouts*: The grade on turnouts should be downward away from the shoulder at a rate of no less than two percent but not greater than five percent for a distance of at least 10 ft for residential turnouts and at least 20 ft and desirably more than 40 ft for commercial and industrial turnouts. Beyond this distance, maximum grades, up or down, should be 15 percent for residential, 8 percent for commercial and 6 percent for industrial turnouts. Grade breaks greater than six percent require vertical curves at least 10 ft long.

B) *Urban driveways*: The driveway grade, up or down, should be not be greater than six percent beginning at the outer edge of sidewalk. Desirably, the driveway grade adjacent to the sidewalk should be between plus or minus two percent for a distance of 10 ft minimum for residential driveways and at least 20 ft but preferably greater than 40 ft for commercial and industrial driveways. Grade breaks greater than six percent require vertical curves at least 10 ft long. In setting the driveway grade, consideration should be given to the impact of roadway drainage on the adjacent property.

#### **404.4 - Driveway and Turnout Paving**

A) *Widening, reconstruction and pavement preservation projects* - in general, the surfacing of the reconstructed turnout will be the same as the existing turnout. Exceptions to this general guidance are given in the ADOT Roadway Engineering Group document "[A Policy for Paving Turnouts](#)". (See Appendix A.) This "Policy" was developed in coordination with the Districts to achieve a statewide logical approach to turnout paving that is economically responsible and also provides some flexibility in individual turnout treatments. It should be utilized as a guide. Written policy from the office of the State Engineer or Deputy State Engineer, Highway Operations may override this policy since the Districts are responsible for permitting of turnouts to State highways.

B) *New construction projects* – except for non-attainment areas, see "A Policy for Paving Turnouts" in Appendix A. Within non-attainment areas, refer to "[Turnout Paving in PM<sub>10</sub> Non-Attainment Areas](#)" also in the Appendix. For more information about PM<sub>10</sub> non-attainment areas, see [Section 113.6](#).

### **405 - Road Access Openings and Connections**

#### **405.1 - Access Openings on Freeways**

In this context, "freeway" refers to interstate highway and all controlled access highways in rural, urban, and fringe/urban areas.

**Except for properly designed ramp entrances and exits, access openings shall not be provided on controlled access highways.**

Maintenance and emergency vehicle crossovers between the divided roadways may be provided on controlled access highways. A list of median crossovers on Interstate highways has been prepared by Central Maintenance Group in coordination with Traffic Engineering Group, the Department of Public Safety and FHWA. Design personnel can access the list at the [ADOT Roadway Predesign](#) website. Median access openings for controlled-access highways other than Interstate are determined by design in coordination with the respective District. Crossovers are to be designed in accordance with the provisions of this chapter. Crossovers should not be paved. Acceleration or deceleration lanes are not required.

Crossovers should not be located within one-half mile of an entrance or exit ramp.

## **405.2 - Access Openings on Other Highways**

In this context, other highways refer to all non-access controlled highways.

A) *Public Road Connections:* Public road connections to State highways other than controlled-access highways should be designed in accordance with the provisions of this chapter.

In rural areas, maintenance and emergency vehicle crossovers may be provided between divided roadways as requested by the District Maintenance Engineer. Crossovers should not be located closer than one mile from an adjacent intersection. Crossovers should not normally be paved so as not to encourage usage. Acceleration or deceleration lanes are not required.

B) *Private Road Connections:* Where permitted, private road connections should meet or exceed the criteria for public road connections.

## **406 - Channelization of Intersections**

### **406.1 – General**

Channelization of an intersection may be warranted by a need to give priority to the predominant traffic movement, to define and minimize points of conflict, to control angles of intersection, to provide storage areas for traffic and refuge areas for pedestrians, to provide space for traffic control devices, to provide for vehicle speed changes, and to control prohibited turning movements.

The design of a channelized intersection can involve some significant controls in addition to the physical controls of terrain and right-of-way. These other design controls include the type of design vehicle, the roadway cross sections, the design speed, the pedestrian characteristics, the type and location of traffic control devices, and the location of any required bus stops.

### **406.2 - Preference to Major Movements**

Whenever possible, it is desirable to give preference to the major traffic movements at an intersection by separating, funneling, stopping or even eliminating the minor movements. Channelization is an effective measure for controlling the minor movements provided natural paths of movement are provided and the channelization is introduced in a way to avoid any element of surprise to the driver.

### **406.3 - Areas and Points of Conflict**

Large multi-lane undivided intersectional areas are usually undesirable. The hazards of conflicting movements are magnified when drivers are unable to anticipate movements of other vehicles within these areas. Channelization reduces areas of conflict by separating or regulating traffic movements into definite paths of travel by the use of pavement markings or traffic islands.

Channelization also separates points of conflict within the intersection and clearly defines vehicle pathways. In designing the channelization, care should be taken to avoid the driver's being exposed to more than one point of conflict or confronted with more than one decision at a time.

### **406. 4 - Refuge and Storage Areas**

Painted or raised traffic islands are used to define and separate the various traffic movements. The shadowing effect of these islands can be used to provide refuge to turning and crossing vehicles. Vehicles may seek shelter from an uncontrolled traffic stream in the shadow of the traffic island while they await the opportunity to cross or enter the stream. Channelization can provide a safer crossing of two or more traffic streams by permitting a driver to wait for proper gaps in the flows one traffic stream at a time.

The channelization should be designed to provide ample storage for vehicles waiting to make the turning or crossing movements.

Properly sized traffic islands can also be used to provide refuge for pedestrians waiting to cross the traffic streams.

### **406. 5 - Traffic Control Devices**

Traffic islands enhance the effectiveness of traffic signal control and provide space for the installation of traffic control devices such as signals and signs. Channelization permits the sorting and storing of approaching traffic for movement through the intersection on separate signal phases. Channelization is particularly effective when used with traffic-actuated signal controls.

In sizing traffic islands, consideration must be given to the dimensions and clearances for traffic control devices which may be installed at the traffic island.

## **407 - Design Vehicles**

### **407.1 – General**

The geometric design of an intersection is greatly dependent upon the dimensional and operational characteristics of the vehicles that are anticipated to use it. The American Association of State Highway and Transportation Officials (AASHTO) has adopted "design vehicles" which represent the various classes of vehicles in common use. The design vehicles representative of those vehicles which are legal in Arizona include: passenger car (P); single-unit truck (SU);

intercity bus (BUS-40 and BUS-45); city transit bus (CITY-BUS); conventional school bus (S-BUS-36); large school bus (S-BUS-40); articulated bus (A-BUS); intermediate semi-trailer (WB-40 and WB-50); interstate semitrailer (WB-62, WB-65 and WB-67); double-trailer combination (WB- 67D); motor home (MH); passenger car with camper trailer (P/T); passenger car with boat trailer (P/B); and motor home with boat trailer (MH/B). It is noted that the AASHTO triple-trailer combination (WB-100T) and turnpike-double combination (WB-109D) are restricted to specific routes in Arizona by legislative action. The configuration of the design vehicles and the minimum turning radii for a 180° turn are as shown in the AASHTO Green Book. Larger minimums may be possible for lesser degrees of turn.

**407.2 - Design Vehicle Selection**

The selection of a design vehicle should be made with care, with consideration given to the appropriate uses of the intersection and the consequences of not providing for the largest vehicles anticipated. The design vehicle is determined by the types of roadways involved, the area where the intersection is located, and the types and volume of vehicles using the intersection. Recommended desirable and minimum design vehicles are given for various types of intersections in Table 407.2. The turning radii given are to the inside edge of the turning lane. (Three-centered curves may also be used at intersections. See Section 408.13).

Major street intersections on highways carrying articulated bus routes should be checked for lane encroachment by the A-BUS design vehicle.

| <b>Table 407.2</b>   |                                      |         |
|--|--------------------------------------|---------|
| <b>Intersection Design Vehicles</b>  |                                      |         |
| <b>Intersection Type</b>   | <b>Design Vehicle</b>                |         |
|  | Desirable                            | Minimum |
| Interstate - Ramp/ Crossroad   | WB-67                                | WB-67   |
| Other Controlled Access- Ramp/ Crossroad   | WB-67                                | WB-62   |
| Junction of Major Truck Routes   | WB-67                                | WB-62   |
|  | <b>Recommended Design Vehicles *</b> |         |
| Junction of State Routes   | WB-62, WB-50, WB-40                  |         |
| Other Rural  | WB-50, WB-40, SU                     |         |
| Urban Major Streets  | WB-50, WB-40, SU                     |         |
| Other Urban  | WB-40, SU, P                         |         |
| * Recommended Design Vehicle to be selected based upon anticipated intersection usage. Alternate Design Vehicles may be selected for special use areas (e.g. A-BUS). |                                      |         |

### **407.3 - Design Vehicle Templates**

The design vehicle templates are as shown in the AASHTO Green Book. Proprietary software programs have been developed to aid the designer by tracking the movement of the selected design vehicle through an intersection. The critical turning vehicles expected to utilize the intersection should be checked to insure proper geometry. Good engineering judgment must be used for intersection layout where truck-turning movements are evaluated for dual turning lanes. In most cases with multiple lanes, it is not practical to design for large trucks to turn within their own lanes and not impact adjacent lanes of traffic. Additional discussion and guidance regarding turning vehicle design at intersections can be found in the AASHTO Green Book, Chapter 9.

## **408 - Intersection Design**

### **408.1 - General**

As discussed in the preceding sections, intersections are inherently areas of conflicting traffic movement. The goal of intersection design is to economically minimize areas of conflict consistent with the constraints of the site.

Proper signing, sight distance and geometric detail gives the driver an opportunity to assess the situation at an intersection and to react accordingly. Signing and traffic control devices, discussed in the *Manual on Uniform Traffic Control Devices for Streets and Highways* (MUTCD), and the Arizona Supplement to the MUTCD, are an integral part of the design of an intersection.

### **408.2 - Application of Sight Distance**

Three types of sight distances should be considered in the design of an intersection: stopping sight distance, intersection sight distance and decision sight distance. At each of these sight distances, the operator of a vehicle should have an unobstructed view of the entire intersection.

The application of the various sight distance requirements for the different types of intersections is shown in Table 408.2.

| <b>Table 408.2</b>  |                       |                                 |                 |
|---|-----------------------|---------------------------------|-----------------|
| <b>Application of Sight Distance Requirements</b>                         |                       |                                 |                 |
| <b>Intersection Types</b>   | <b>Sight Distance</b> |                                 |                 |
|   | <b>Stopping</b>       | <b>Intersection<sup>1</sup></b> | <b>Decision</b> |
| Driveways and turnouts  | x                     | x                               |                 |
| Driveways and turnouts with heavy truck traffic                           | x                     | x                               |                 |
| Private roads   | x                     | x                               |                 |
| Public roads and streets  | x                     | x                               |                 |
| Signalized intersections and roundabouts                                  | x                     | x                               |                 |
| State route intersections & route direction changes                       | x                     | x                               | x               |
| <sup>1</sup> See <a href="#">Sections 408.4</a> and <a href="#">408.5</a> |                       |                                 |                 |

### 408.3 - Stopping Sight Distance

Stopping sight distance shall be provided throughout all parts of intersections (see [Section 201.2](#)).

#### 408.4 - Intersection Sight Distance

**Sight Triangles** – An area along the approach legs of intersections between approaching vehicles should be kept clear of any obstructions that might block the sight of an approaching vehicle on an intersecting path. This area is referred to as the clear sight triangle. The dimensions of the clear sight triangles are determined by the design speeds of the intersecting roadways and the traffic control type used at the intersection. The two types of clear sight triangles used in intersection design are approach sight triangles and departure sight triangles. (See Figures 408.4A and 408.4B). The sight triangles are checked for obstructions using a driver eye height of 3.5 ft and an object height 3.5 ft above the road surface. The 3.5 ft object height represents that portion of a passenger car height that must be visible in order for another driver to recognize it as the object. When checking the sight triangle for a single-unit or combination truck, the driver eye height is assumed to be 7.6 ft above the roadway surface.

*A) Approach sight triangle – Figure 408.4A:* There must be an unobstructed sight distance along all approaches to an intersection and across the included corners sufficient to permit operators of approaching vehicles to see each other (decision point) and to perceive, react and complete an appropriate accelerating, slowing or stopping maneuver. Figure 408.4A depicts clear sight triangles both left and right for traffic approaching an uncontrolled or yield-controlled intersection. Distance “a” is required for a vehicle approaching on the minor road that would normally yield or stop as necessary for the vehicle on the major road. Distance “b” is required on the major road for a vehicle having the right-of-way to avoid the vehicle on the minor road, if necessary.

*B) Departure sight triangles – Figure 408.4B:* After a vehicle has stopped on the minor road approach to depart an intersection, the driver must have sufficient sight distance both left and right along the intersecting roadway to make a safe departure movement to the left, right or through. Clear departure sight triangles from the minor road as shown in Figure 408.4B should be provided for stop-controlled and yield-controlled intersections and some signal-controlled approaches. The clear sight triangle also affords the driver of a vehicle on the major road to see any vehicle stopped on the minor road and be prepared to slow or stop if needed.

The dimensions of departure sight triangles are determined by gap-acceptance methodology based upon observed driver behavior. Gap acceptance involves the driver’s evaluation of available gaps in an opposing traffic stream and the decision to carry out a specific maneuver within a particular gap.

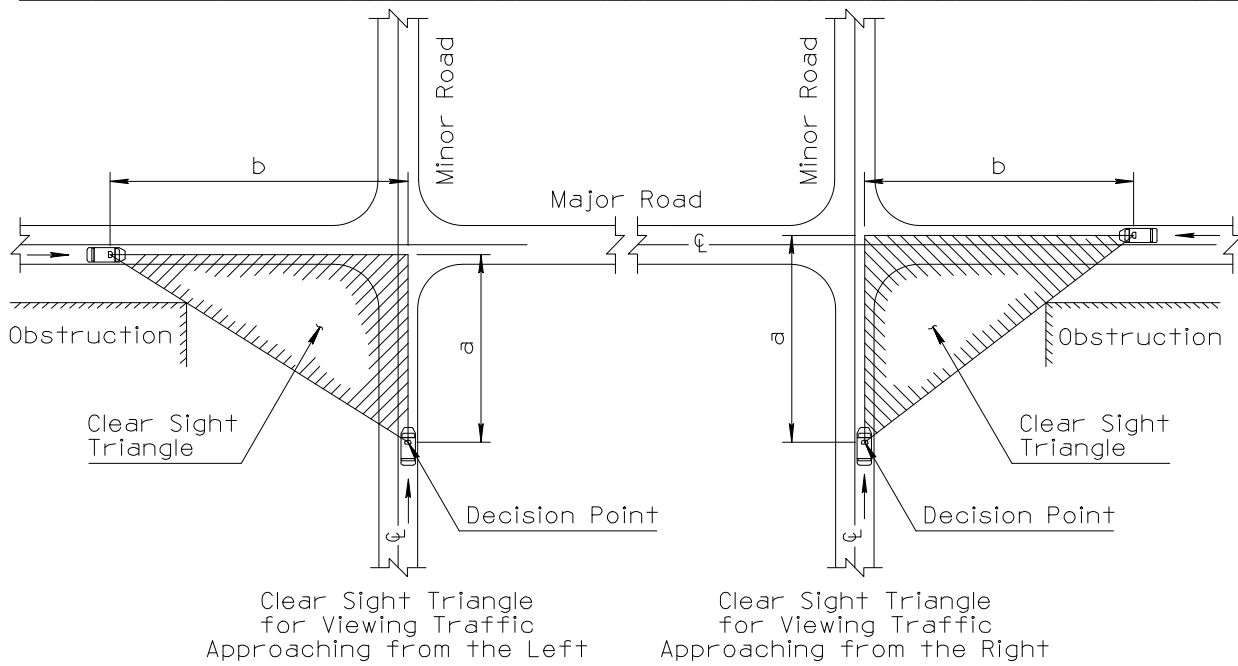

**APPROACH SIGHT TRIANGLES  
FIGURE 408.4A**

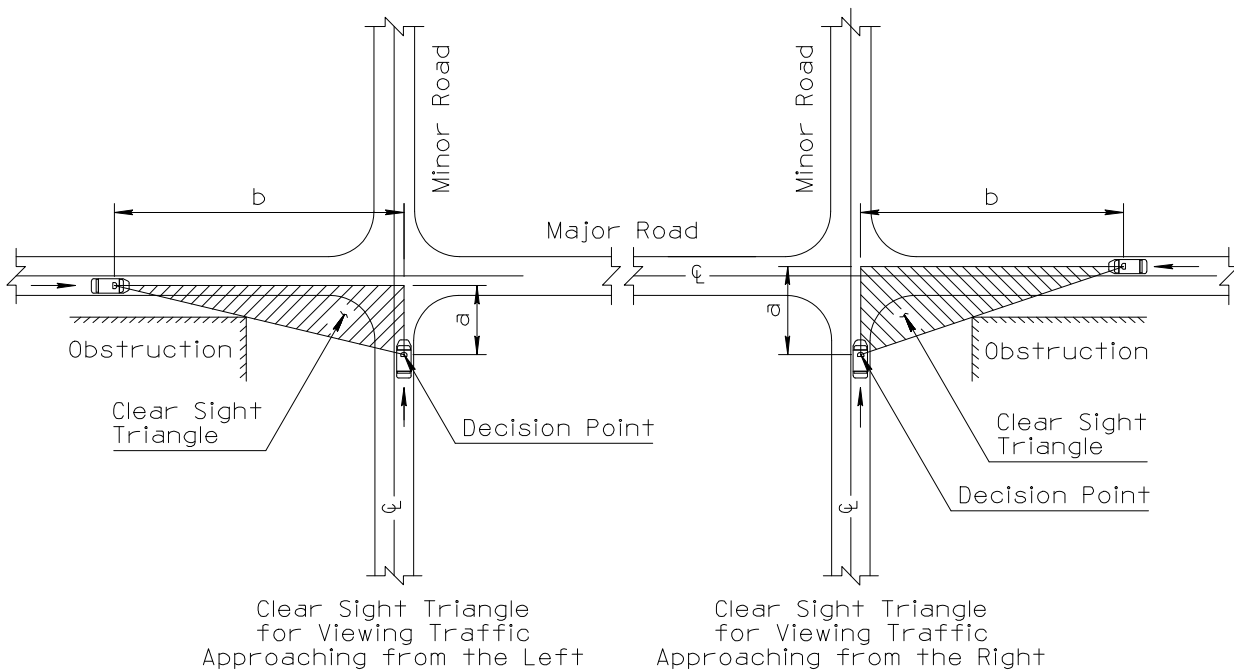

**DEPARTURE SIGHT TRIANGLES  
FIGURE 408.4B**

**INTERSECTION SIGHT TRIANGLES**

## 408.5 Intersection Control

This section provides a general discussion of the various types of intersection control and requirements for intersection sight distance. Since the intersection control type determines how drivers behave at intersections, the procedures to determine sight distance requirements vary with the type of control. The following design guidance provides basic information regarding the various AASHTO control cases. The designer should utilize the AASHTO Green Book Chapter 9 for a complete discussion of the design requirements and design tables for the different cases.

The AASHTO Cases are:

Case A – Intersections with No Control

Case B – Intersections with Stop Control on the Minor Roadway

Case B1 – Left Turns from the Minor Road

Case B2 – Right Turns from the Minor Road

Case B3 – Crossing the Major Road from the Minor Road Approach

Case C – Intersections with Yield Control on the Minor Road

Case C1 – Crossing Maneuver from the Minor Road

Case C2 – Left-Turn and Right-Turn Maneuvers from the Minor Road

Case D – Intersections with Traffic Signal Control

Case E – Intersections with All-Way Stop Control

Case F – Left Turns from the Major Road

### ***AASHTO Case A – Intersections with No Control***

Except in very rare instances, all intersections on State highways will have either stop (or yield) control. (Turnouts and unpaved roads connecting to State highways may be considered to be under stop control even though stop signs are not present.)

Where there is no stop or yield control, clear approach sight triangles should be provided as described in [Section 408.4](#). The sight distances along each approach should be no less than the distances given in AASHTO Green Book Exhibit 9-51 for the design speed of each roadway. These distances reflect the time required by an approaching vehicle to perceive and react to another approaching vehicle and to change speed or stop before reaching the intersection.

**If all corners of the intersection cannot be cleared and maintained to provide unobstructed views within the sight triangles, the intersection shall have stop control imposed.**

### **AASHTO Case B – Intersections with Stop Control on the Minor Roadway**

In CASE B, the major road traffic passes freely through the intersection without stop control and the minor road traffic has stop control. These names refer only to the relative importance of the roads at the intersection and not to their functional classification.

Imposing stop control on the minor legs of an intersection requires providing adequate sight distance on the minor road so that a driver traveling at the design speed can perceive and react to the stop sign and safely bring the vehicle to a complete stop before reaching the stop sign.

Once stopped, the driver must have intersection sight distance to oncoming traffic on the major road which will permit making departure movements. (See [Figure 408.4B](#) for departure sight triangles.)

There are three basic departure movements as described in the following sections that should be considered for stop control on the minor roadway.

#### **AASHTO Case B1 – Left Turns from the Minor Road (Stop Control)**

The recommended intersection sight distance for Case B1 is the length of the leg “b” of the departure sight triangle (Figure 408.4B) along the major road in both directions. This distance is that traveled by the major leg vehicle at the design speed during the gap time and is determined by AASHTO Formula 9-1:

$$\text{ISD} = 1.47 V_{\text{major}} t_g \quad \text{where:}$$

**ISD** = intersection sight distance (length of the leg of sight triangle along the major road) (ft)

**V<sub>major</sub>** = design speed of major road (mph)

**t<sub>g</sub>** = time gap for minor road vehicle to enter the major road (seconds)

Under normal conditions, the critical sight distances left and right are those associated with the turning movements. It takes longer time to turn the vehicle and accelerate to average operating speed than to go straight across the intersecting highway.

The decision point of the sight triangle along the minor road may be assumed to extend 14.5 ft from the major road outside edge of travel-way. Where practical, it is desirable to increase this distance to 18 ft to provide a larger sight triangle. The leg “a” of the departure sight triangle (Figure 408.4B) is the sum of this distance plus the distance to the center of the near crossing lane from either left or right.

The determination of the intersection sight distance for AASHTO Case B1 can be made utilizing AASHTO Green Book Exhibits 9-54 and 9-55. The intersection sight distances in AASHTO Exhibit 9-55 are for a stopped passenger car turning left onto a two-lane highway. These distances must be adjusted for a design vehicle other than a passenger car, multiple through lanes, median width between through lanes, and minor road approach grades exceeding 3%. These adjustments are made utilizing the time gap adjustments provided in AASHTO Exhibit 9-54.

Examples on how to adjust the time gap are included in the AASHTO Green Book discussion.

Median width time gap adjustments are made by converting the median width to equivalent lane widths and increasing the gap time by the number of additional lanes to be crossed. In addition to the departure sight triangles for the stopped vehicles on the minor road, a departure sight triangle to the right for left turns from the median should be checked for the largest applicable design vehicle that can be stored in the median with adequate clearance (3 ft to front and back of stopped vehicle) to the through lanes. When there is adequate space for the design vehicle to stop in the median, no separate analysis is normally needed for the departure triangle for left turns for minor-road approaches for the near roadway to the left since the departure sight triangle for right-turning vehicles (Case B2) will provide adequate sight distance for a passenger car to cross into the median. Exceptions should be checked and are discussed in AASHTO Case B3.

When the design vehicle cannot be stored in the median width provided with adequate clearance to the through lanes, the sight triangle to the right must be provided using the adjustments in gap time. Other treatments (i.e. wider median, acceleration lanes, or signals) can be considered to safely allow the stopped design vehicle to enter crossing traffic.

If an intersection is expected to have a significant amount of single-unit or combination trucks stopping at the intersection, the time gaps with adjustments for these vehicles (AASHTO Exhibit 9-54) should be utilized to determine the intersection sight distance. This should be done in addition to checking for the passenger vehicle.

If the intersection sight distances along the major road cannot be provided, consideration should be given to installation of regulatory speed signing on the major road approaches.

### **AASHTO Case B2 – Right Turns from the Minor Road (Stop Control)**

For right turns onto the major road, a departure sight triangle to the left should be provided as shown on [Figure 408.4B](#). The intersection sight distance is determined in the same manner as provided in AASHTO Case B1 except the gap time should be adjusted. Field studies have shown that drivers turning right will accept gaps of approximately one second less than when turning left. AASHTO Exhibit 9-57 with adjustments as shown should be utilized when calculating the time gaps for Case B2.

AASHTO Exhibit 9-58 provides the intersection sight distance for a stopped passenger car entering a two-lane crossroad. The time gaps for the selected design vehicle must be adjusted for conditions of multilane highways, median width, and approach grade on the minor road and the intersection sight distance must be recalculated using AASHTO Equation (9-1).

When the intersection sight distance cannot be achieved, consideration should be given to providing regulatory speed control or other traffic control on the major road.

### **AASHTO Case B3 – Crossing the Major Road from the Minor Road Approach (Stop Control)**

Providing intersection sight triangles left and right for Cases B1 and B2 will, in most instances, safely accommodate a crossing maneuver from the minor road. There are three instances identified by AASHTO where the availability of sight distances should be checked for crossing.

- where left and/or right turns are not permitted from an approach and the crossing maneuver is the only legal maneuver;
- where the crossing vehicle would cross the equivalent of more than six lanes; or
- where substantial volumes of heavy vehicles cross the highway and steep grades on the far side of the intersection might slow the vehicle while its back portion is still in the intersection.

AASHTO Equation (9-1) is used to determine leg “b” of the departure sight triangle ([Figure 408.4B](#)) and the time gaps with adjustments are provided in AASHTO Exhibit 9-57. AASHTO Exhibit 9-58 provides the intersection sight distances required for a stopped passenger car to cross a basic two-lane major roadway; adjustments must be made to these values for type of vehicle, multilane highways, median width and approach grades exceeding 3% from the minor roadway.

For divided highway intersections, depending upon the design vehicle length and the median width, sight distances may need to be checked for the stopped vehicle crossing both roadways of the divided highway or for crossing the near lanes only, stopping in the median, and then crossing the far lanes.

### **AASHTO Case C – Intersections with Yield Control on the Minor Road**

Sight distances required for yield control exceed those required for stop control. Two separate pairs of approach sight triangles as shown on [Figure 408.4A](#) are needed for four-legged intersections. One pair of sight triangles is needed to accommodate crossing of the major road and a separate pair of sight triangles is needed to accommodate left and right turns onto the major road. The following discussion of Case C1 and Case C2 provide the requirements for each.

For three-leg intersections with yield control on the minor road, only the clear sight triangles for left and right turns need to be satisfied.

When intersection sight distances cannot be provided based upon the following analyses, consideration should be given to imposing stop control on the minor road or reducing the regulatory speed signing on the major road.

**AASHTO Case C1 – Crossing Maneuver from the Minor Road (Yield Control)**

The length of the minor crossing leg “a” of the approach sight triangle and the travel time required for the crossing vehicle are shown in AASHTO Exhibit 9-60. This analysis is the same as in Case A except that the assumption for the deceleration of the vehicle on the minor road is to 60% of the design speed rather than 50% as in Case A. Adjustments to AASHTO Exhibit 9-60 values for the distances and times are made using the factors provided in AASHTO Exhibit 9-53. Sight triangle legs for design vehicles other than passenger cars need to be calculated separately.

The intersection sight distance along the major road, leg “b” of the sight triangle is computed using AASHTO Equations (9-2). AASHTO Exhibit 9-61 can be used to determine the values of leg “b” using the unadjusted values of AASHTO Exhibit 9-60.

If the median width is sufficient to store the design vehicle for the crossing maneuver, then only the crossing of the near lanes need to be considered and the departure sight triangle for a stopped vehicle, Case B3 should be provided. If the median width is not wide enough to store the design vehicle, Case B1 with adjustment for median width should be applied.

**Case C2 – Left-Turn and Right-Turn Maneuvers (Yield Control)**

Vehicles turning left and right from the minor approach roadway are assumed to reduce their speed to a turning speed of 10 mph. A length of 82 ft is assumed for leg “a” of the approach sight triangle for both left and right turns.

AASHTO Exhibit 9-63, with adjustments as shown, is used to calculate time gaps for Case C2.

AASHTO Exhibit 9-64 provides leg “b” sight distance lengths for passenger cars for left and right turns. Separate sight distance calculations are needed for other design vehicles on the minor approach roadway and for multilane highways.

**AASHTO Case D – Intersections with Traffic Signal Control**

Where signals are provided, the first stopped vehicle on any leg should be visible to the first stopped vehicle on all other legs of the intersection. No other intersection sight triangles need be checked for signalized intersections except:

1. For right turns permitted on a red signal, the departure sight triangle to the left for Case B2 should be clear; and
2. If a traffic signal operates on two-way flashing mode (yellow on the major leg and red on the minor leg) during off-peak or nighttime operation, departure sight triangles for Case B to the left and right should be clear for the minor road approach.

**AASHTO Case E – Intersections with All-Way Stop Control**

For intersections with stop control on all approach legs, the first stopped vehicle on any leg must be visible to the first stopped vehicle on each other leg of the intersection. No other intersection sight distance criteria apply.

**AASHTO Case F – Left Turns from the Major Road**

All locations where left turns are provided along a major highway should provide sufficient sight distance for a driver to decide whether it is safe to negotiate the turn across opposing traffic. It is assumed that the vehicle is turning from a stopped condition.

The sight distance required to make the left-hand turn across traffic is the distance traveled at the design speed of the major road in the gap time required to make the turn for the selected design vehicle as shown in AASHTO Exhibit 9-66. Adjustments to Exhibit 9-66 gap times are required as shown for additional lanes to be crossed.

AASHTO Exhibit 9-67 provides a table for intersection sight distances required for a passenger vehicle to make a left turn from an undivided highway. The time gap should be adjusted for additional lanes to be crossed and truck design vehicles and the sight distance required then recalculated.

If stopping sight distance is provided on the major roadway approaching the intersection and intersection sight distance for Case B (stop control) or Case C (yield control) is provided for each minor road approach, there is generally no need to check for Case F. Left turns from the major roadway within a horizontal curve or crest vertical curve should be checked for potential median obstructions within the sight triangles.

Designs for opposing left-turn lanes should be considered that prevent blocking of available sight distance for left turns by opposing vehicles and provide better views of oncoming traffic.

**408.6 - Decision Sight Distance**

Decision sight distances given in AASHTO Exhibit 3-3 should be provided when practical at intersections where a State Route turns or intersects another State Route. For measuring decision sight distance, a 3.5 ft eye height and 2 ft object height should be used, the object being located on the side of the intersection nearest the approaching driver.

**408.7 - Effect of Skew**

The configuration of the sight triangles can be radically affected by the skew of an intersection. Some of the factors for determination of intersection sight distance may need adjustment when two roadways intersect at an angle greater than 30 degrees from a right angle. AASHTO Exhibit 9-69 provides a graphic of intersection sight triangles at skewed intersections. Since the legs of the intersection are skewed, the sight triangles are either larger or smaller than those of a right-

angle intersection. The length of the path for crossing movement from the minor road will be longer and the length of the turning path left or right will be either longer or shorter. When the path lengths are longer, the gap times utilized for each AASHTO Case applicable must be adjusted by the equivalent number of additional lanes created by the skew. This is the sum of lane width and median width to be crossed divided by the sine of the acute intersection angle; this resultant length divided by 12 less 1 (the exhibit value for two-lane roadway) provides the equivalent number of additional lanes for the gap time adjustment for the respective Case exhibits.

Since heavily skewed intersections may be difficult for some drivers to negotiate, it is recommended that stop control should be imposed on the minor road to allow the driver time to adequately utilize the clear sight triangles.

For design guidance on the usage of skewed angle intersections, see [Section 403.4](#).

#### **408.8 - Intersection Vertical Profile**

Desirably, intersections should be on as flat a grade as possible to minimize adverse impacts on vehicle acceleration and stopping characteristics. If practical, the maximum grade on any leg of an intersection (excluding driveways and turnouts) should be three percent. **Grades greater than six percent (excluding driveways and turnouts) shall not be used without the approval of the Assistant State Engineer, Roadway Engineering Group.**

The intersection sight distance requirements given in the previous sections have been developed assuming flat grades. No corrections need to be made to these sight distances for grades of three percent or less. The design procedures provided in [Section 408.5](#) provide for the adjustments to intersection sight distance needed for approach grades exceeding 3 percent.

Careful attention should be given to the differences between the minor leg grades and the major leg cross slope. The maximum algebraic difference between approach grade and cross slope should be four percent for signal control, yield control or no control intersections. For stop control intersections where future signalization is not anticipated, the maximum algebraic difference should not exceed six percent. Where the major roadway is superelevated, a vertical curve profile connection for the minor leg approach may be desirable to eliminate the effects of grade break and provide a smooth crossing.

See [Section 504](#) for ramp-crossroad intersections.

#### **408.9 - Effect of Horizontal Alignment**

Whenever practical, the alignment of the major road should be tangent at an intersection. The minor road should be realigned to provide a tangent approach to the intersection.

When curvature on the major road requires superelevation greater than 0.03 ft/ft, consideration should be given to increasing intersection sight distances to allow for the reduced acceleration rate of the departing vehicle. Factors for consideration include the distance the vehicle travels on the cross slope, the minor leg grade and the major leg grade.

### **408.10 - Left-turn Channelization**

*A) General:* A left-turn lane serves to expedite the flow of through traffic, to control the movement of turning traffic, and to improve the safety and capacity of the intersection.

Traffic Engineering Group will analyze the traffic movements and other factors at an intersection to determine the need for a separate left-turn lane(s) and establish the vehicle storage requirements for the lane(s).

The left-turn lane should be laid out such that the turning vehicle must make a definite move to enter the lane.

Guidance for the design of turning lanes for at-grade highway intersections is provided in the Traffic Engineering Policies, Guidelines, and Procedures (PGP) Section 430. The PGP is available on the Traffic Engineering Group website.

*B) Design Elements:*

*Width* - The width of the left-turn lane should be from 10 to 12 ft, with a desirable width of 12 ft. On rural and urban high-speed highways, 11 ft is the minimum and should be used only where right-of-way or other constraints preclude the full width lane. Ten ft wide left-turn lanes may be used on urban low speed highways.

*Medians* - When left-turn lanes are placed in raised (curbed) medians, a minimum of 4 ft should remain at the nose for pedestrian refuge and placement of traffic control devices.

To provide the most efficient traffic movement, left-turning motorists need to see opposing traffic. To improve left-turn visibility, the left-turn lane should be offset as far to the left as possible in the median, leaving only the painted or curbed nose.

*Approach taper* - On highways with narrow or no medians, room for the left-turn lane is made by shifting traffic laterally to the right. The taper rate used to effect this shift should be V:1, where V is the design speed in mph. Thus, if the additional lane width, W, is to be gained solely from one side of the highway, the length of approach taper would be (V times W). Depending on circumstances, the additional width for the left-turn bay may be obtained from either or a combination of both sides of the highway.

*Gap Length* - The gap length is the distance required for the vehicle to shift from the through lane into the left-turn lane. See Traffic Engineering Group PGP 430.

*Storage length* - Storage length consists of the braking distance plus a queue length dependant upon the anticipated traffic control for the intersection and the traffic demand at the turn. See Traffic Engineering PGP 430. Vehicle queue length requirements are determined by the Traffic Engineering Group. As a minimum, the queue length should provide space for two passenger cars at 25 ft each. If the peak hour truck traffic is 10% or more, the queue length should be 85 ft minimum to provide space for one passenger car and one truck.

The end of the storage lane should be located to accommodate the wheel paths of the appropriate design vehicle turning template.

C) *Dual left-turn lanes*: The use of dual left-turn lanes should be coordinated with the Traffic Engineering Group. Generally, dual left-turn lanes should be considered when the left-turn demand is greater than 300 vehicles per hour.

D) *Two-way left-turn lane*: Continuous two-way left-turn lanes are often used in urban and fringe-urban areas to treat the special capacity and safety concerns associated with left-turn demands at high-density strip developments. Two-way left-turn lanes may be used with either two-lane or multi-lane highways. The lane width should be no less than that of the through traffic lanes.

#### **408.11 – Right-Turn Channelization**

A) *General*: Right-turn lanes can be justified on the basis of capacity improvements and safety by permitting vehicles to slow down, stop as required and then turn right without impeding the flow of through traffic. Because right turns are usually made at lower speeds than through movements, safety is enhanced if the slower turn is made in a separate, exclusive lane.

Right-turn lanes are beneficial where pedestrian volumes are heavy by providing storage space for vehicles waiting for pedestrians to clear the crosswalk.

The analysis and design of right-turn lanes should consider pedestrian movements. Traffic Engineering Group will analyze the traffic movements at an intersection to determine the need for a separate right-turn lane and establish the vehicle storage requirements for the lane.

As with left-turn lanes, right-turn lanes should be laid out such that right-turning vehicles must make a definite move to enter the lane.

The desirable length of the right-turn lane is the sum of storage requirements and gap.

*B) Design Elements:*

*Width* - The width of the right-turn lane should be 12 ft. In urban areas, an 11 ft wide lane may be used or, if severely constrained, a 10 ft wide lane may be used. See [Figure 408.11A](#).

Minimum shoulder width for right-turn lanes (non-curb and gutter) is provided in [Table 302.4](#).

*Gap length* - The gap length is that required for the vehicle to shift from the through lane into the right-turn lane. The taper which guides the motorist into the right-turn lane is a straight line along the right edge of the traveled way. See Traffic Engineering PGP 430.

*Storage length* - Vehicle storage requirements are determined by Traffic Engineering Group.

As a minimum, the storage length should provide space for two passenger cars at 25 ft each. If the percentage of truck traffic on the highway is 10 per cent or more, the storage length should be a minimum of 85 ft to provide space for one passenger car and one truck.

*C) Offset Right Turns:* Offset right-turn lanes from the main roadway are sometimes utilized to improve available sight distance for the left-turning vehicles stopped at the side road. Larger right-turning vehicles in conventional right-turn lanes can temporarily block the view of approaching traffic. This may be more prevalent with a heavy mix of larger trucks using the right-turn lane. Offsetting the right-turn lane further to the right can provide clear sight triangles for the left departing vehicles. The offset distance required will vary and can be obtained by applying the intersection sight distance criteria in Section 408.5 to obtain adequate gaps for the entering traffic. The roadway designer should work closely with the traffic pavement marking designer for location of the side road stop bar.

*D) Free Right Turns:* Free right turns (without signal or sign control) are often used to improve the capacity of an intersection with a heavy right turn demand. The right turn is made "free" by channelizing the turning movement outside of the intersection controls. For free right turns to function properly, vehicles should not turn into a through traffic lane. Rear-end accidents can occur as turning cars slow down or stop while waiting for gaps in the through cross-traffic stream. If turning traffic must stop, it is better to take the turning movement through a controlled intersection where it is expected to stop, then turn as cross traffic permits.

**Free right turns shall only be provided where the turning movement can be made into an auxiliary or acceleration lane.**

*E) Bicycle Buffer:* Where bicycles are expected to be prevalent, a buffer area between the through lane and the right-turn lane should be provided. [Figure 408.11A](#) shows the bicycle buffer with a wide curb lane. The buffer area is formed by the extension of the through lane and the face of curb line. [Figure 408.11B](#) shows the bicycle buffer for non-curb and gutter sections. The buffer may be omitted where bicycle traffic or right-turn traffic is expected to be infrequent.

**408.12 - Acceleration Lanes**

Acceleration lanes should be provided where vehicles are entering a highway from a free right-turn movement or where there is a significant number of vehicles turning right through a stop or yield-controlled movement. The width of the acceleration lane should be 12 ft with a minimum of 10 ft in very restricted urban areas.

Where practical, the length of the acceleration lane should provide for a passenger car to accelerate to 85 percent of the design speed of the highway. The acceleration lane should transition into the outside through lane using a taper at a ratio of the design speed in mph to one (V:1) (See [Figure 408.12A](#)). For restricted conditions, one-third of the taper length may overlap the acceleration length (See [Figure 408.12B](#)).

Acceleration distances are given in the table on [Figure 408.12A](#)

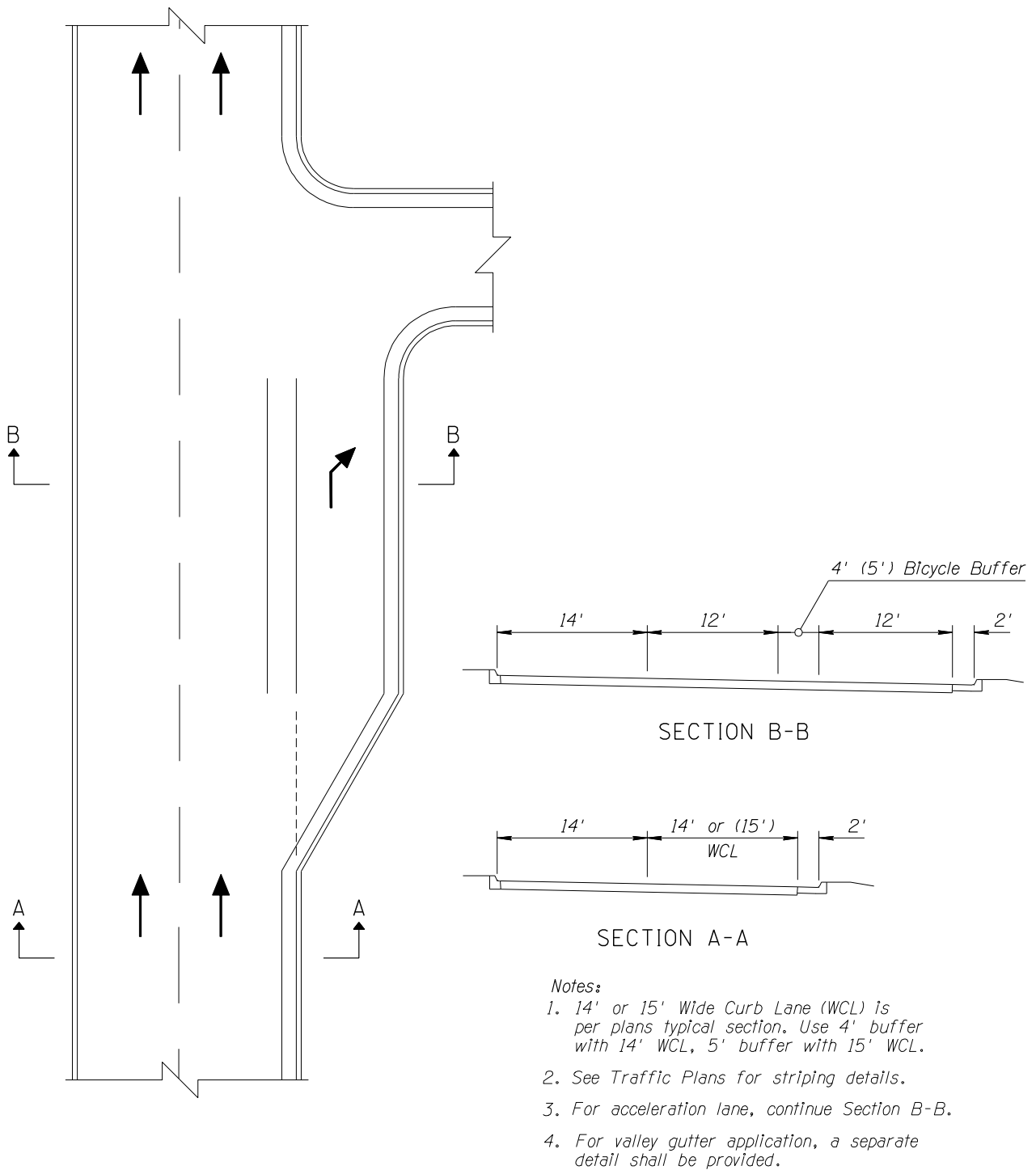

**BICYCLE BUFFER – WIDE CURB LANE  
FIGURE 408.11A**

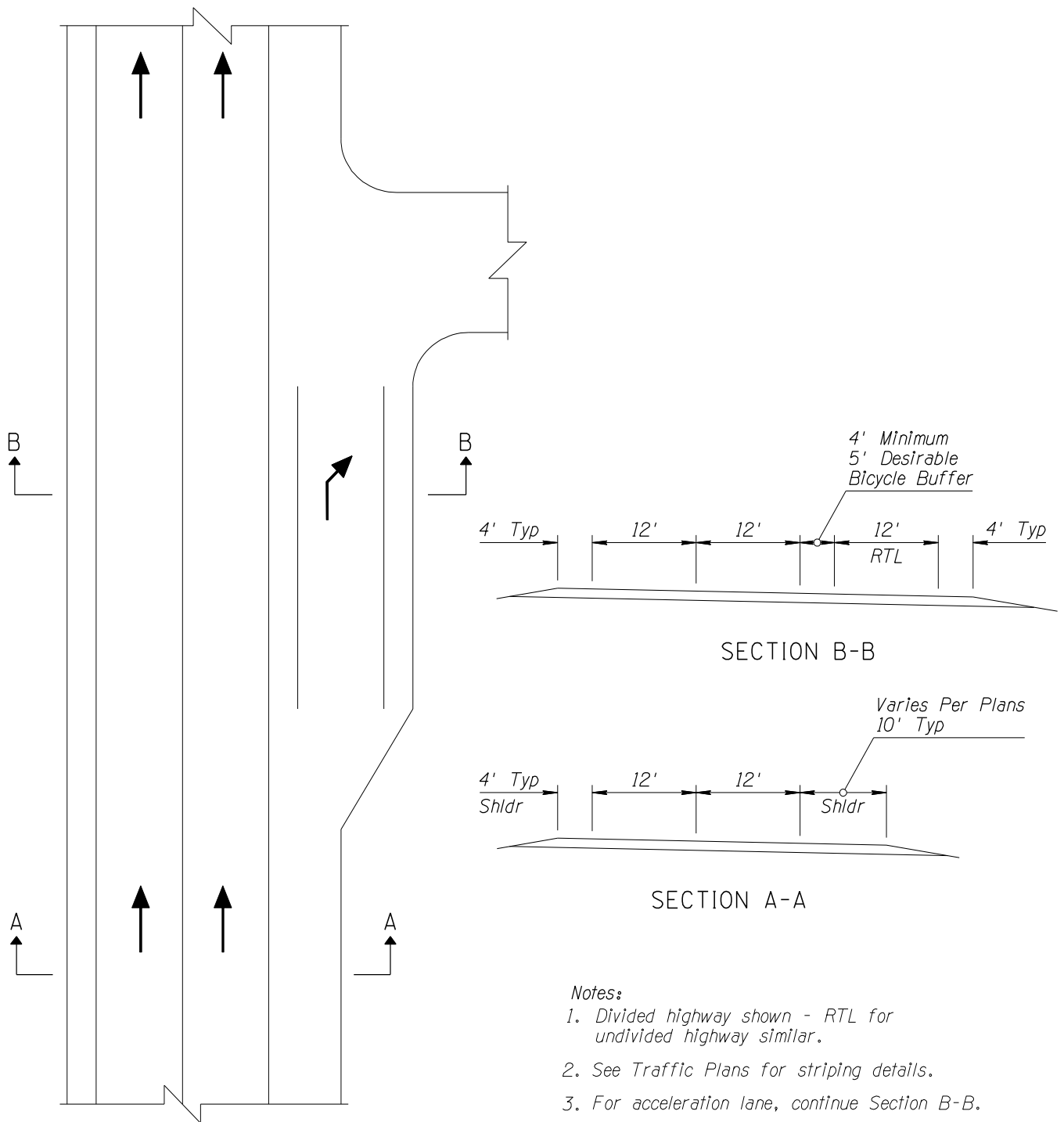

**BICYCLE BUFFER – NON-CURB & GUTTER**  
**FIGURE 408.11B**

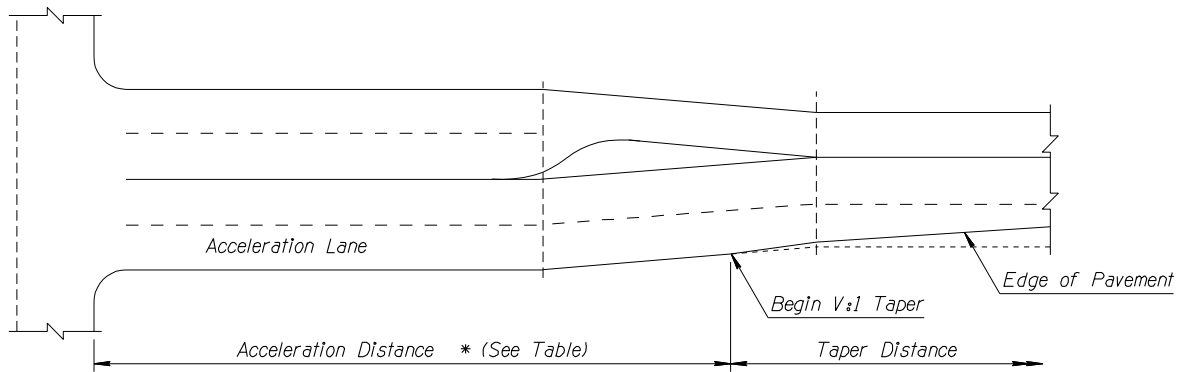

**NOTE**

*V = Design Speed in MPH.  
Acceleration Taper is Relative to Adjacent Through-Lane Edge.*

**\* Acceleration Distance Table**

| Design Speed (MPH) | Distance (Ft) |
|--------------------|---------------|
| 20                 | 100           |
| 30                 | 150           |
| 40                 | 300           |
| 45                 | 400           |
| 50                 | 500           |
| 55                 | 650           |
| 60                 | 800           |
| 70                 | 1300          |
| 75                 | 1600          |

**ACCELERATION LANE CONFIGURATION  
FIGURE 408.12A**

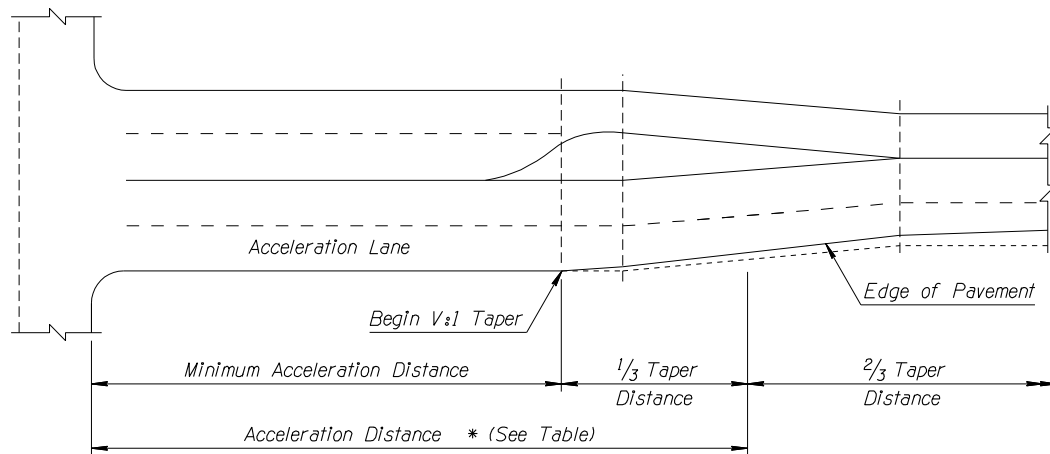

**NOTE**

*V = Design Speed in MPH.  
Acceleration Taper is Relative to Adjacent Through-Lane Edge.*

**MINIMUM ACCELERATION LANE CONFIGURATION  
FIGURE 408.12B**

### 408.13 - Traffic Islands

*A) General:* Traffic islands are used to control vehicle movements or to provide a refuge for pedestrians. Traffic islands are located between traffic lanes and are most commonly designated by striping, raised pavement markers, or curbs.

Traffic islands serve to:

1. Confine specific traffic movements into definite channels;
2. Separate traffic moving in the same or opposite direction;
3. Aid and protect pedestrians crossing the intersection; and
4. Discourage or prohibit undesirable movements.

*B) Design:* Traffic islands vary in size and shape depending upon the configuration of the intersection and the purpose which the island serves.

Traffic islands must be large enough to be seen and to command the attention of the driver. Islands for channelizing should preferably be at least 100 square feet in area but not less than 75 square feet. Curbed islands for separating traffic streams should not be less than 4 ft wide and 25 ft long.

In general, the plan of a traffic island will follow the adjacent through-traffic lanes and turning roadways. Curbed islands should be offset from the through-traffic lanes by a minimum of 2 ft. If the approach roadway is curbed, the same offset may be used at the traffic island.

While traffic islands must command attention, they must not come as a surprise to the driver. The approach end of a curbed island should be rounded at a 2 ft radius. The 2 ft rounded approach end may be tapered 2 ft each side at 15:1 to aid in guiding the driver into the channelization.

Where there is an approach shoulder (4 ft or wider), the curbed island should be offset from the through lane by the width of the shoulder and a flared approach is not necessary. Proper sight distance must be provided in accordance with [Section 408.3](#).

While the intent is for traffic islands to command the attention of the driver, they must do so while presenting the least possible obstacle to the public. The use of curbed traffic islands should be avoided where the approach operating speeds are 50 mph or greater. Vertical type curbs should normally be used where there are pedestrian crossings. Sloping curbs may be considered for special applications where pedestrian crossing is not provided.

*C) Corner Traffic Islands:* The primary controls on the design of turning roadways at intersections are the alignment of the inside pavement edge and the pavement width necessary to accommodate the design vehicle making the turn at the design speed of the intersection. With radii greater than minimum, there may be an area between the limits of the turning roadway and the adjacent through lanes for a traffic island. As discussed above, traffic islands in such locations

are useful to help guide the turning and through traffic, provide for the placement of signs and traffic control devices, and provide a refuge for pedestrians.

Increasing the turning radii to provide traffic islands may lead to increased right-of-way and construction costs. In evaluating the use of traffic islands, the designer must weigh the potential increased costs against the benefits they may bring, with due consideration of the traffic volumes; percentage and type of trucks; and pedestrian usage projected for the intersection.

#### **408.14 - Turning Roadways and Intersection Curvature**

*A) General:* As stated in the introduction to this chapter, intersection curves and turning roadways provide the connection between roadways at an intersection, enabling motorists to turn from one road to the other. Vehicles turning at intersections designed for minimum radius turning paths operate at low speeds--usually 10 mph or less. See [Section 407.3](#) for design vehicle turning templates. The efficiency of the intersection can often be improved by providing for higher-speed turns.

The operating characteristics for intersections are different from the open highway. Due to the various warnings provided, drivers tend to anticipate more critical conditions at intersections permitting the use of less conservative design factors. Drivers generally operate at higher speeds in relation to curvature at intersections than on open highway curves because they accept and use higher side friction on curves at intersections than on the open highway.

*B) Design Speed:* The design speed for a turning roadway should be commensurate with the design speeds of the connected roadways. Turning roadways do not include minimum turning paths at low speeds of 10 mph or less. Where design speeds of the connected roadways are different, each terminus of the turning roadway should have the same design speed as the adjacent roadway while the design speed of the "turning roadway proper" should approach the design speed of the roadway being entered.

*C) Horizontal curvature and superelevation:* The superelevation [Tables 202.3A-D](#) provided in Chapter 200 apply to roadways having 30 mph and greater design speeds.

Based upon generally accepted values of side friction for low-speed turns, it is possible to establish a relationship between minimum radii and minimum superelevation for various design speeds. These minimum values are given in [Table 408.14](#) for design speeds above 10 mph and below 30 mph.

Providing greater rates of superelevation will permit a commensurate reduction in the minimum radius for a given design speed. Variations due to greater rates of superelevation can be determined from the values given in AASHTO Exhibit 3-16.

ADOT limits superelevation rates to 0.04 ft per ft in urban areas. An appropriate maximum rate of superelevation for rural intersections is 0.06 ft per ft. Table 408.14 has minimum curve radii for each of these conditions.

| <b>Table 408.14</b>  |             |      |      |     |     |     |     |     |     |     |     |     |     |     |
|--|-------------|------|------|-----|-----|-----|-----|-----|-----|-----|-----|-----|-----|-----|
| <b>Minimum Radii and Superelevation for Low Speed Turning Roadways</b>   |             |      |      |     |     |     |     |     |     |     |     |     |     |     |
| Superelevation (%)   |             | -2.0 | -1.5 | 0.0 | 1.5 | 2.0 | 2.2 | 2.4 | 2.6 | 2.8 | 3.0 | 3.2 | 3.4 | 3.6 |
| DESIGN SPEED   | 15 mph (ft) | 50   | 49   | 47  | 45  | 44  | 44  | 44  | 43  | 43  | 43  | 43  | 42  | 42  |
|  | 20 mph (ft) | 107  | 105  | 99  | 94  | 92  | 91  | 91  | 90  | 89  | 89  | 88  | 88  | 87  |
|  | 25 mph (ft) | 198  | 194  | 181 | 170 | 167 | 165 | 164 | 163 | 161 | 160 | 159 | 158 | 157 |
| Superelevation (%)   |             | 3.6  | 3.8  | 4.0 | 4.2 | 4.4 | 4.6 | 4.8 | 5.0 | 5.2 | 5.4 | 5.6 | 5.8 | 6.0 |
| DESIGN SPEED   | 15 mph (ft) | 42   | 42   | 42  | 41  | 41  | 41  | 41  | 41  | 40  | 40  | 40  | 40  | 39  |
|  | 20 mph (ft) | 87   | 87   | 86  | 85  | 85  | 84  | 84  | 83  | 83  | 82  | 82  | 81  | 81  |
|  | 25 mph (ft) | 157  | 155  | 154 | 153 | 152 | 151 | 150 | 149 | 148 | 147 | 146 | 145 | 144 |
| 1. Values from AASHTO Green book, Exhibit 3-16, computed using Superelevation Distribution Method 2.<br>2. For use with turning roadways (Design speeds greater than 10 mph and less than 30 mph). |             |      |      |     |     |     |     |     |     |     |     |     |     |     |

*D) Pavement Width for Turning Roadways:* Pavement edge alignment and pavement width are critical factors in the design of turning roadways. Where corner traffic islands are to be provided, the inner edge of the turning lane pavement should be designed to provide at least the minimum island and the minimum turning roadway pavement. The turning roadway pavement should be wide enough to permit the outer and the inner wheel tracks of the design vehicle to be within the edges of the pavement by about 2 ft on each side. Where widths greater than 15 ft are required for design vehicles, the extra width should be considered for striping or other delineation to discourage usage as two turning lanes.

*E) Turning radius:* As the front of the vehicle enters the turn, the inner rear wheel (the critical wheel for determining the inner pavement edge alignment) begins a spiral track until reaching the sustainable turning radius. As the vehicle leaves the turn, the rear wheel once again follows a spiral path, increasing its radius until reaching a tangent alignment where it fully tracks the leading wheel. Throughout the turn, the track of the inner rear wheel is offset inward from the leading wheels making it the critical wheel path. Likewise, the path of the front outside overhang controls the location of the outer edge of the turning roadway pavement.

Corner radii at intersections are provided to ease the movement of vehicles making a turn, especially trucks and buses. The turning radii are based upon the design vehicles appropriate for the types of intersections discussed in [Section 407.2](#).

Many local governments have adopted standards for turning radii at intersections and those standards should be followed at local road intersections with State highways where the radii would be greater than those called for in Section 407.2.

Where the minimum turning radius is provided, encroachment upon adjacent lanes should be checked using the turning template for the desirable design vehicle.

Encroachment of the design vehicle into adjacent lanes should be avoided. Infrequent encroachments into same-direction lanes by larger vehicles may be acceptable if it is demonstrated that other traffic will not be unreasonably impeded.

At intersections where traffic volumes justify separate turning lanes or where large numbers of trucks turn, the pavement edge should be defined by a three-centered curve.

*F) Three-centered curves:* Three-centered compound curves are useful for reducing right-of-way and pavement width requirements from those of a simple curve. The designer can first use the design vehicle turning radius program or template to determine the minimum path for the vehicle. The three-centered curves may then be used to more closely fit the turning path and thereby reduce the paved area to accommodate utilities, limited right-of-way or other restrictions. AASHTO Green Book Exhibit 9-20 can be utilized to select three-centered compound curves (symmetrical and asymmetrical) that will accommodate the design vehicles and the angle of turn required. Minimum edge of traveled-way designs for various design vehicles making a 90° turn are illustrated in AASHTO Exhibits 9-21 through 9-28.

The value for "offset" given in AASHTO Exhibit 9-20 is the distance to be added to the central curve radius to locate the curve center from the pavement edge of the through lane. Straight tapers may be substituted for the longer radii curves.

## CHAPTER 500

### TRAFFIC INTERCHANGES

#### 501 - Introduction

##### 501.1 - General

A traffic interchange connects two or more vertically separated roadways. The interchange comprises the ramps that connect the separate roadways and the structures that provide the vertical separation. In this document, the terms "traffic interchange" and "interchange" have the same meaning unless the context dictates otherwise.

All connections to controlled-access highways are through interchanges. Interchanges may also be used to connect non-controlled access highways where traffic volumes or other considerations preclude the use of normal at-grade intersections.

##### 501.2 - Spacing

The location of traffic interchanges will be determined by the expected traffic demand for access to the facility. In urban areas, the minimum spacing of interchanges should be 1 mile. In rural areas, the spacing should be no less than 2 miles. A minimum spacing of 2 miles should be provided between system interchanges and service interchanges. If required, access to more closely spaced crossroads in urban areas may be attained by using collector-distributor roads, braided ramps, auxiliary lanes, or other techniques.

#### 502 - Interchange Types

##### 502.1 - General

The selection of an interchange type is determined by such factors as the number and type of intersecting roadways, traffic volumes, terrain, traffic speeds, cost, community impacts, traffic composition, the number of movements to be accommodated, right-of-way constraints, consistency with other interchanges in the area, local planning issues, and environmental considerations. Traffic operations will generally control the design of an interchange, but cost and site conditions quite often predominate in the selection of interchange types.

Interchange types are generally identified by the configuration of their ramps. As shown in [Figure 502.1](#), ramp configurations may be classified as diamond, loop, trumpet or directional. Generally, the same type of ramp would be used throughout an interchange; however, there are many situations where traffic operations or site constraints will require combinations of the basic types. In addition to the following discussion on interchange types, see the AASHTO Green Book Chapter 10 for discussion on interchange types and applications.

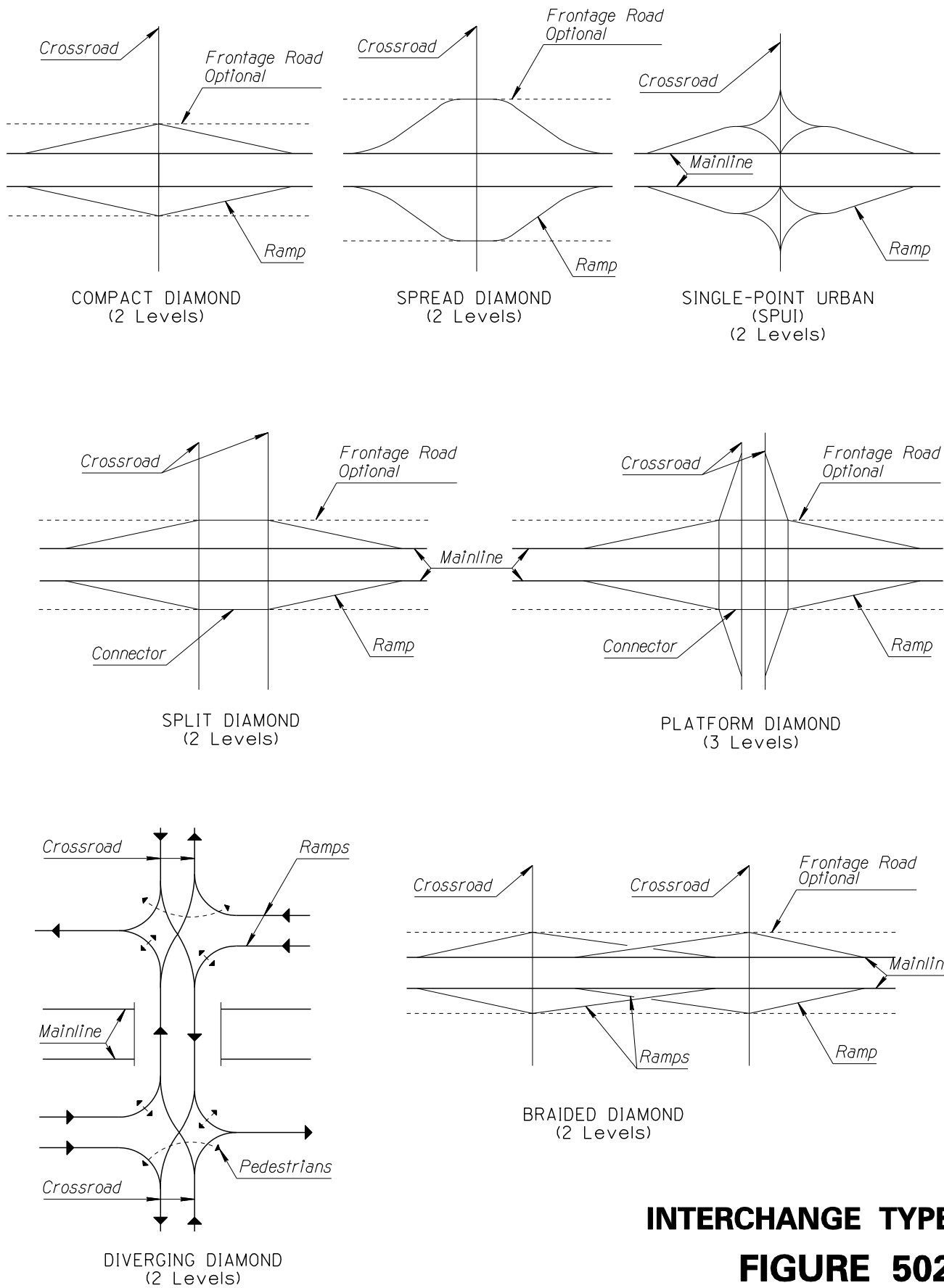

**INTERCHANGE TYPES**

**FIGURE 502.1**

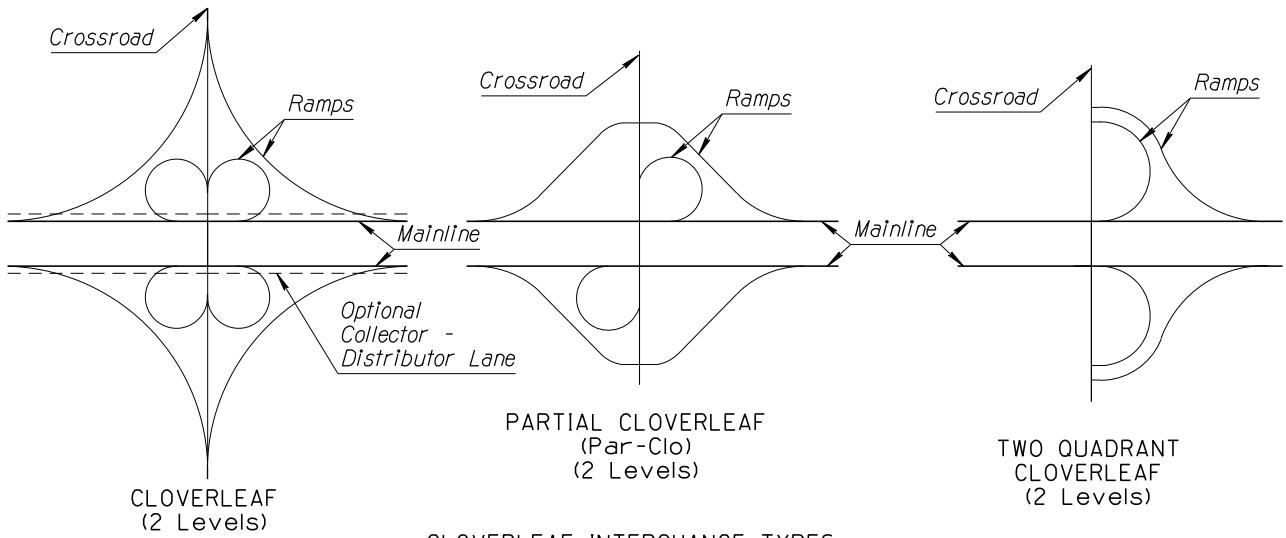

CLOVERLEAF INTERCHANGE TYPES

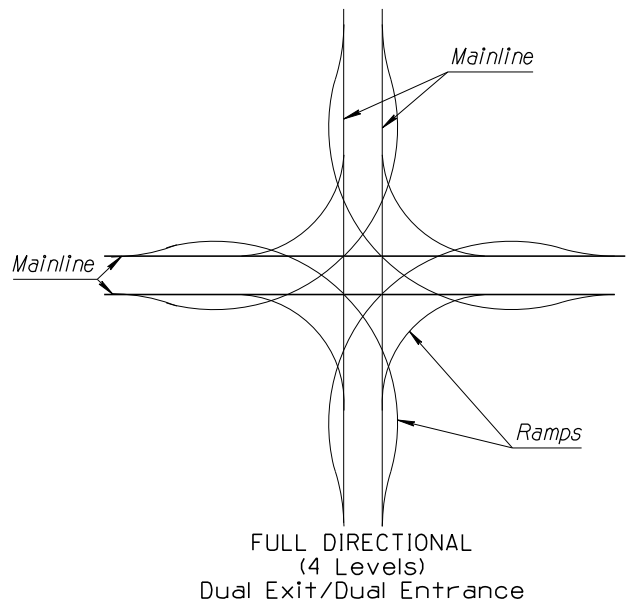
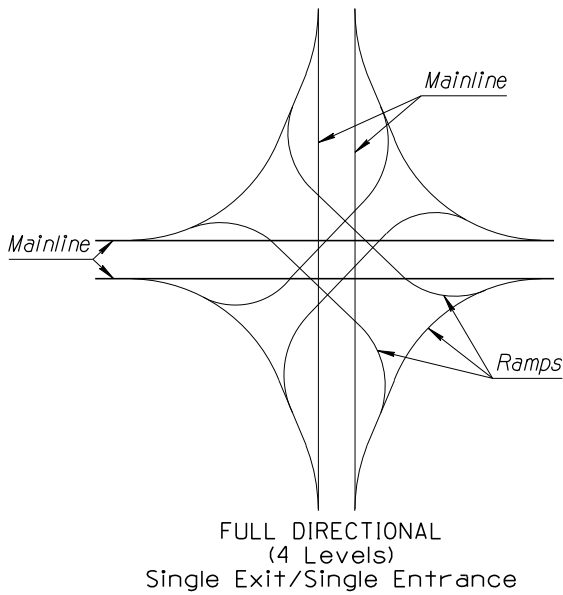
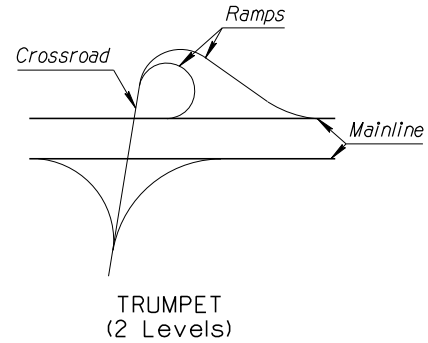
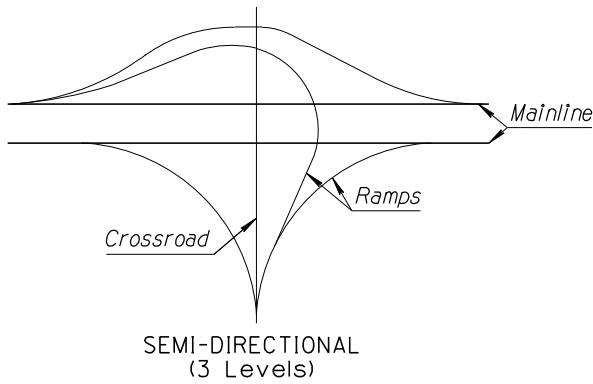

DIRECTIONAL INTERCHANGE TYPES

**INTERCHANGE TYPES**

**FIGURE 502.1**

## 502.2 - Diamond Interchanges

Diamond interchanges are characterized by ramps that are essentially in the same direction as the main roadway. Four ramps provide for all eight turning movements to and from a crossroad.

Diamond interchanges are the simplest of the interchange types. Drivers are very familiar with the operational aspects of the diamond interchange; it is simple in concept and logical in use.

Diamond interchanges usually have minimum construction costs and provide direct turns at the crossroad. High standards of ramp geometry can be provided. The diamond is adaptable to a wide range of traffic volumes. The interchange capacity is limited by the capacity of the ramp/crossroad intersections.

A) *Compact Diamond:* This is probably the most commonly used type of interchange for a freeway to crossroad connection. Economically, it is most adaptable to situations where the mainline highway is elevated or depressed and the crossroad is at grade, eliminating the need for significant ramp and crossroad earthwork. Right-of-way requirements are minimal; often the interchange can be accommodated within the normal highway right-of-way. This type of interchange tends to lose efficiency with an increase in demand for left turns at the ramp/crossroad intersections. The compact diamond may effectively be used with frontage roads.

B) *Spread Diamond:* This type of interchange is most often seen on rural controlled-access highways where the mainline highway is at-grade and the crossroad is elevated to pass over the highway. The ramp-crossroad intersections are at-grade but shifted away from the highway for economy and to provide intersection sight distance along the crossroad vertical alignment. The spread diamond type of interchange requires a significant amount of right-of-way and tends to be inefficient with high left-turn volumes at the ramp/crossroad intersections. Where right-of-way costs are high, it may be more cost effective to use the compact diamond and elevate (or depress) the crossroad and ramps. The spread diamond may be effectively used with frontage roads.

C) *Single Point Urban Interchange (SPUI):* This type of interchange shifts the intersection of the ramps and the crossroad toward the center of the interchange. The use of "inside left turns" to reduce the number of traffic signal phases significantly increases the left-turn efficiency of the interchange. This interchange type may also be used with frontage roads; however, the efficiency of the interchange is reduced by the additional traffic signal phases required for the frontage road through traffic. The ramp horizontal geometry necessary to accommodate the inside left turns will often require more right-of-way than the compact diamond and the lack of space for a center overpass bridge pier will generally make this type more expensive than the compact diamond. The potential for increased cost should be weighed against the potential for greater operational efficiency.

D) *Split Diamond:* The split diamond is essentially a compact diamond interchange of which the two halves have been separated along the axis of the highway. This type of interchange is generally used to provide access to a pair of one-way crossroads. Continuity between the ramp/crossroad intersections is provided by a connecting roadway. The split diamond interchange has the operational characteristics of a compact diamond.

E) *Platform Diamond*: When traffic volumes and operational constraints do not permit left turns from the crossroad an acceptable alternative to loop ramps or a directional interchange may be a platform diamond. The platform diamond type of interchange is formed by diamond-type ramps from both the highway and the crossroad intersecting at a separate platform where the turning movements are made. Vertically, the platform is located between the highway and the crossroad for the greatest efficiency. With proper planning, a split diamond interchange with a closely spaced, high-volume pair of one-way roads can be readily converted to a platform diamond to provide greater capacity at a reasonable cost.

F) *Diverging Diamond (DDI)*: This alternative diamond interchange moves the cross street traffic to the left side of the roadway between the signalized ramp intersections. The left-turn signal phase at the ramp terminals is eliminated. Vehicles on the cross street wanting to turn left are allowed to continue to the ramps without conflicting with opposing through traffic and without stopping. Pedestrians cross the junction in two stages with the central island as a refuge. Advantages offered by a DDI over conventional interchange designs include a two-phase operation, fewer conflict points, narrower bridge structure, less R/W, lower construction costs, reduced congestion and delay, decreased speeds, reduced environmental impact and possible increased safety. DDIs appear to be most applicable where there are heavy left turns onto the ramps or moderate to heavy left turns from the ramps.

G) *Braided Diamond*: This type of interchange is used when it is necessary to provide direct access to and from crossroads which are too close for the efficient operation of independent interchanges or a collector-distributor system but too far apart for a split diamond to be effective. In this type of interchange, the on- and off-ramps which lie between the crossroads A and B are "braided" that is, one crosses over the other. Thus, on the mainline, there would be two consecutive off-ramps (to crossroads A and B) followed by two consecutive on-ramps (from crossroads A and B).

Crossing or braiding the on-ramp from crossroad A with the off-ramp to crossroad B eliminates the need to provide for the merging and weaving of on-traffic from crossroad A with the off-traffic to crossroad B and permits having two interchanges with crossroads which are too closely spaced for the proper functioning of collector-distributor roads or other types of interchanges.

### 502.3 - Loop Interchanges

A) *Cloverleaf*: The four-quadrant cloverleaf has free-flow characteristics for all movements. It has the disadvantage of a higher cost than the diamond or the partial cloverleaf interchanges. The relatively short mainline weaving distance between the loop ramps limits capacity. Collector-distributor roads should be incorporated in this design to separate the weaving conflicts from the mainline through traffic.

Full cloverleaf interchanges are not desirable for connecting intersecting controlled-access highways.

*B) Partial Cloverleaf (Par-Clo):* The par-clo provides loop on-ramps to the highway in addition to the four spread diamond-type ramps. This interchange is suitable for large volume turning movements. Left-turn movements from the crossroad are eliminated, thus permitting two-phase operation at the ramp intersections when signalized. Loop off-ramps are not desirable.

*C) Two-Quadrant Cloverleaf:* The simplest of the loop interchanges is the two-quadrant cloverleaf. This type of interchange is less efficient operationally than the diamond interchange and should be used only where controls such as right-of-way or short weaving distances preclude the use of diamond ramps in all four quadrants. When the two-quadrant cloverleaf must be used, the designer should select the quadrants to minimize the storage requirements of the crossroad left-turn traffic. Loop off-ramps are not desirable.

#### **502.4 - Directional Interchanges**

A directional interchange provides exit ramps which, after leaving the mainline, turn in the intended direction of travel and connect to the new direction without a stop or traffic signal control. Because of their high cost, directional interchanges are only used to provide access between very high volume interchanges such as intersecting controlled access highways.

*A) Trumpet Interchanges:* This type is often used when a crossroad terminates at the highway. It has free-flow characteristics for all movements but requires somewhat greater right-of-way than the diamond type. This interchange type should not be used if the future extension of the crossroad is probable. A diamond interchange would be preferable in this situation.

The trumpet is an effective interchange to connect a terminating controlled access highway with another. It is also useful for a terminating non-controlled highway in rural areas where the loop ramp volumes are low.

*B) Full Directional Four-Level Interchange:* The four-level directional interchange with all direct connections provides the maximum in convenience, efficiency and safety. Because of its high construction costs, the four-level interchange should be used only where there is a high demand for all turning movements such as at system interchanges. Exit ramps at directional interchanges may consist of a) single exit with a directional split introduced on the exit ramp or b) a separate exit for each direction with the ramps crossing and grade separated with a structure. See [Figure 502.1](#). Alternative b) provides a reduced footprint for construction and may improve the operational efficiency by separating the exiting traffic prior to the exit. The additional costs for a bridge structure to grade separate the two ramps must be considered. Directional ramps entering the mainline may also be combined into a single entrance or remain separate for each movement. Combinations of single and dual exit and entrance ramps may be used in the quadrants of any directional interchange.

C) *Semi-Directional Interchange*: Due to the high construction costs of the fully-directional interchange, it is sometimes economical to provide directional ramps only for the turning movements with heavy demand. The much less expensive loop ramps may be provided for the lighter turning movements, as appropriate. The collector-distributor roadway system required to facilitate the merge-diverge operations of the loop ramps should be considered in making economic comparisons.

### **503 - Interchange Selection and Design**

#### **503.1 - General Considerations**

The purpose of an interchange is to link a highway with another traffic facility without impeding the flow of through traffic on the highway. The type of interchange and the design considerations will be dependent upon the facilities being connected. In selecting and designing an interchange, the parameters which must be considered include cost, environment, community values, traffic volumes, route continuity, signing, system balance, alignment, traffic service, safety, and consistency.

A) *Cost*: The cost differential between the various types of interchanges can be very significant. A careful analysis must be made to assure that an interchange is neither over nor under designed. The analysis should include all construction and right-of-way costs. Where appropriate, staging possibilities should be considered. Provisions could be made for adding or upgrading ramps at a later time.

B) *Environment*: Environmental issues are identified in the project environmental reports. The designer should coordinate with Environmental Planning Section to assess the impacts of environmental issues on the type and configuration of an interchange.

C) *Community values*: Community values that may impact interchange design will generally be identified in the environmental reports or through the public involvement process. The designer should coordinate with Environmental Planning Section to make certain that community values are given full consideration in the interchange design process.

D) *Traffic volumes*: The interchange should be configured to accommodate through and turning traffic volumes in an efficient manner. In general, high volume turning movements should be as direct as possible. Lower volume turning movements may be indirect. All turning movements should be provided for at interchanges, either directly or indirectly. Partial interchanges or split interchanges with long circuitous connectors should be avoided.

E) *Route continuity*: The sign route and the major traffic volume should be to the left at interchanges. Left-hand exits from the through sign route are generally unacceptable. When conditions require, left-hand exits may be used with the approval of the Assistant State Engineering, Roadway Engineering Group and the Traffic Engineering Group Manager.

F) *Signing:* Interchanges can be complex and confusing to the unfamiliar driver. In designing interchanges, careful consideration should be given to the requirements of a clear directional system. This is particularly important on major interchanges where several sequential choices are available, on interchanges where turning movements are somewhat circuitous, and at lane drops and exit-only lanes.

G) *System balance:* The level of traffic service provided by an interchange can impact the overall efficiency of the street and highway network. Under-designed interchanges can introduce congestion on the approach street or highway which will reduce the system capacity. In other instances where there is congestion on a highway due to repetitive bottlenecks, temporary closures or accidents, interchanges serve as linkages to permit traffic to bypass the congestion. At interchanges with important local arterials, and at interchanges between controlled-access highways, the designer should provide as much flexibility in capacity as feasible to enable the transportation network to adjust to any unbalance.

Also, to the greatest extent possible, an interchange should not significantly reduce the level of traffic service of the major facility.

H) *Lane balance:* The traffic volumes per lane of the mainline should remain reasonably constant throughout the interchange, including the approaches. It is critical to maintain the basic number of through lanes through an interchange. The preferred treatment is shown in AASHTO Exhibit 10-50C which demonstrates coordination of lane balance with the basic number of lanes.

I) *Alignment:* The alignment of an interchange is dependent upon site conditions including the alignments of the crossing roadways, right-of-way, terrain, and environmental requirements. Each interchange site will have its own set of constraints and thus it is not reasonable to set forth fixed alignments for interchanges.

In general, the alignments should be designed to provide as compact an interchange as is practical. However, where there is a strong potential for growth in traffic using the interchange over the design volumes, the interchange alignment should be such that expansion or upgrading of the interchange can be readily accommodated.

J) *Traffic service:* In designing an interchange, the primary goal is to serve the interests of the motorists: the highway through traffic, the local through traffic, the local interchange traffic and the highway-to-highway traffic. Often these interests are in conflict and interchange solutions favoring one will be at the disadvantage of others. In general, traffic service priorities should favor the highway through traffic, with the highway-to-highway interchange traffic being of next importance. Service for the local interchange traffic and the local through traffic should be of lesser importance.

The above prioritization does not mean that safety or geometric standards should be compromised for local interchange or local through traffic. Rather, it means that in the case of a demand for both a highway-to-highway interchange and a local access interchange in the same area, the highway-to-highway traffic service should be accommodated firstly and the local access provided only if it can be provided at a reasonable cost and without significant reduction of highway-to-highway service.

*K) Safety:* Safety is of utmost importance and the interchange design should provide to the fullest extent possible geometric standards significantly above minimum requirements. Particularly in the case of complex interchanges, careful attention must be given to the location of exit ramps and direction signing to give the motorist ample time to evaluate the situation and to decide what action to take.

### **503.2 - General Design Guidelines**

Geometric design recommendations set forth in other sections of this manual should be followed in the design of all features of the through highway within the interchange area.

All ramps and connections within the interchange area should meet the geometric recommendations set forth in other sections of this manual except as modified in the following sections.

### **503.3 - Design Speed**

The design speed of a State highway through an interchange should not differ from the design speed of adjacent sections of the highway. (See [Section 101.2](#))

The design speed for the full length of directional ramps connecting controlled-access highways should be 10 mph less than the mainline design speeds but not less than 55 mph. However, the initial ramp curve preferably should be designed for the mainline design speed.

The design speed for interchange taper-type exit ramps at the mainline gore should be 10 mph less than the mainline design speed. For parallel-type exit ramps, the first curve should be 5 mph less than the mainline design speed. The design speed through the main body of the ramp desirably should be 50 mph. Progressively lower design speeds may be used beyond the mainline gore if required to accommodate loop ramps and other geometric features.

The design speed for the entrance ramp curve preceding the entrance taper should be 10 mph less than the mainline speed.

The minimum design speed at the crossroad terminus of a ramp should be 35 mph.

The minimum design speed of loop ramps should be 30 mph.

The minimum design speed of crossroads at an interchange should be 40 mph but not less than the design speed of the crossroad approaches to the interchange.

### 503.4 - Sight Distance

One-and-one-half (1.5) times the stopping sight distance given in [Figure 201.2](#) should be provided on the mainline at the approaches to ramp exits to aid drivers in identifying the location of the ramp and to safely complete their movements onto the ramp. The sight distance is measured from the center of the right-hand approach lane to the center of the right-hand ramp lane at the exit nose control point (See [Figure 504.7](#)).

One-and-one-half (1.5) times the stopping sight distance given in [Figure 201.2](#) should be provided on the mainline at the approaches to ramp entrances. The sight distance is measured from the center of the mainline right-hand lane to the center of the ramp at the entrance nose control point (See [Figure 504.8A](#)).

The sight distances at ramp-crossroad intersections should be as for at-grade intersections (See [Chapter 400](#)).

Crossroad bridge railings, mainline abutments or abutment slopes may need to be set back from their normal location to provide the required sight distance at ramp-crossroad intersections.

The sight distance along ramps should be as given in [Figure 201.2](#). Providing the required sight distance may have significant impacts on the ramp horizontal and vertical geometry. Additionally, ramp shoulder widths on tight curves having guardrail or safety barriers may be adjusted when practical to provide the desired sight distance.

### 503.5 - Interchange Alignment

*A) Mainline:* The horizontal alignment between ramp termini should desirably be on tangent or a flat horizontal curve to enhance horizontal sight distance and to enable the driver to focus more on traffic movements through the interchange. Spiraled horizontal curves should be avoided.

The mainline vertical alignment through an interchange should desirably provide greater sight distance than recommended in [Section 503.4](#).

*B) Crossroads:* The horizontal alignment of a crossroad should be tangent through the interchange to at least 100 ft beyond the ramp intersection with the crossroad. Where tapers are required for the crossroad approaches to the interchange, the tangent alignment should extend through the taper area.

**The maximum grade of a crossroad adjacent to ramp termini shall be three percent.**

## **504 - Ramp Design**

### **504.1 - Ramp Vertical Alignment**

A) *Ramp grades:* Ramp grades should be as flat as feasible and consistent with the design standards of the through highway.

For interchange and directional ramps, the desirable maximum upgrade is four percent and the desirable maximum downgrade is five percent. An absolute maximum ramp grade of six percent may be used only if warranted by site restrictions. The impact of steep up-grades on vehicle speed must be considered when using grades greater than the desirable.

For 400 ft in advance of traffic signals, the maximum grade should be three percent. The minimum grade for ramps is 0.4 percent for roadways with curb and gutter; otherwise the minimum grade should be 0.25 percent.

**Within the paved gore area and adjacent to the mainline, the ramp profile shall satisfy the allowable cross slope breakover as given in [Section 504.3](#).**

B) *Ramp vertical curves:* Interchange ramp vertical curves should be a minimum of 200 ft in length at the terminus with a crossroad. Elsewhere, the ramp vertical curve lengths should be in accordance with the ramp design speed with a minimum length of 400 ft. See [Figures 204.4A](#) and [C](#) for the vertical curve lengths required to provide minimum sight distances.

Angular breaks in profile grade should be kept to 2% or less at the junction of a ramp or ramp/frontage road with a crossroad cross slope. Grade breaks up to 4% are allowable when terrain or geometric conditions require. Grade breaks over 4% should be avoided except in special circumstances where justification can be provided.

### **504.2 - Ramp Horizontal Alignment**

The horizontal alignment of a ramp should be as straight as is practical. Horizontal curves should be as flat as conditions permit; the minimum radius curve should be the exception rather than the rule. The radii of successive curves should have a ratio of 2:1 or less. The horizontal and vertical alignments must be coordinated to meet the stopping sight distance requirements; to provide a graceful, aesthetically pleasing roadway; and to give the driver a safe and pleasant driving experience.

The minimum radius of curvature for directional and interchange ramps should be in accordance with [Tables 202.3](#) as appropriate for the design speed and the maximum allowable superelevation.

**For loop ramps (where the net angular change in direction exceeds 135 degrees), the minimum radius shall be 230 ft.**

The radius of a ramp horizontal curve in the vicinity of a gore nose will generally be controlled by the superelevation required for the curve so as to not exceed the maximum allowable breakover in superelevation between the ramp and the adjacent mainline lane. (See [Section 504.3](#).)

Ramp curves generally should not have spirals, except at the second exit of a dual exit ramp (Figure 502.1), introduction of a spiral with the first curve is often the most practical method to introduce the initial ramp geometry in order to meet the paved gore breakover criteria described in [Section 504.3](#), and the desired design speed.

For directional ramps, the minimum length of horizontal curves should be as given in [Section 203.5](#). For other ramps, the minimum length of curve should not be less than 300 ft in low-speed locations and 500 ft in high-speed locations.

Tangents between reversing curves should be long enough to facilitate superelevation transition (See [Sections 202](#) and [203](#)).

Ramps should have a tangent alignment for 160 ft or greater from the end of curve to crossroad edge of pavement.

### 504.3 - Ramp Superelevation

The discussion of superelevation in Section 202 applies also to the design of ramps. In urban areas, the maximum ramp superelevation should not exceed 0.06 ft/ft ([Table 202.3B](#)). The maximum ramp superelevation in rural areas is dependent upon elevation and climatic conditions.

Superelevation transitions should be in accordance with the discussion in [Section 202.3](#). Superelevation transition lengths should be the values given in [Tables 202.3 B, C, and D](#), as appropriate. Superelevation distribution should be in accordance with [Figure 202.3B](#). In restrictive cases where the length of curve or tangent (between reverse curves) is too short to transition to the standard superelevation, the values given in [Tables 202.3B](#) may be reduced by as much as 30%.

The superelevation transition between compound curves should be distributed with 0.7 of the length on the flatter curve and 0.3 on the sharper curve.

**Entrance and exit ramps shall have the same cross slope as the adjacent mainline lane on the mainline side of the gore nose except that a maximum 2% breakover between the adjacent mainline and ramp is permissible for parallel type ramps as shown in [Figures 504.7](#) and [504.8A](#).**

Between the paved gore nose and the back of the paved gore, the ramp and mainline cross slopes may differ; i.e., they may be in different planes. **The maximum algebraic difference in cross slopes between a paved shoulder and the adjacent gore paving shall not exceed 5%.** See [Figure 504.7, Sheet 1](#).

#### **504.4 - Side Slopes**

The desirable ramp side slopes are shown in [Figure 504.4A](#) and [B](#) for urban and rural areas.

The urban area ramps are shown as curbed while those for the rural area are uncurbed. Details for an uncurbed urban area ramp would be similar to those shown for the rural area ramps.

The side slopes of ramps should be as flat as possible in compliance with the requirements of [Chapter 300](#). The requirements for barriers on embankment sections should be as shown in [Figure 303.2](#). To the extent practical, ramp geometry should be designed such that the side slopes do not require barriers on either the ramp or the mainline.

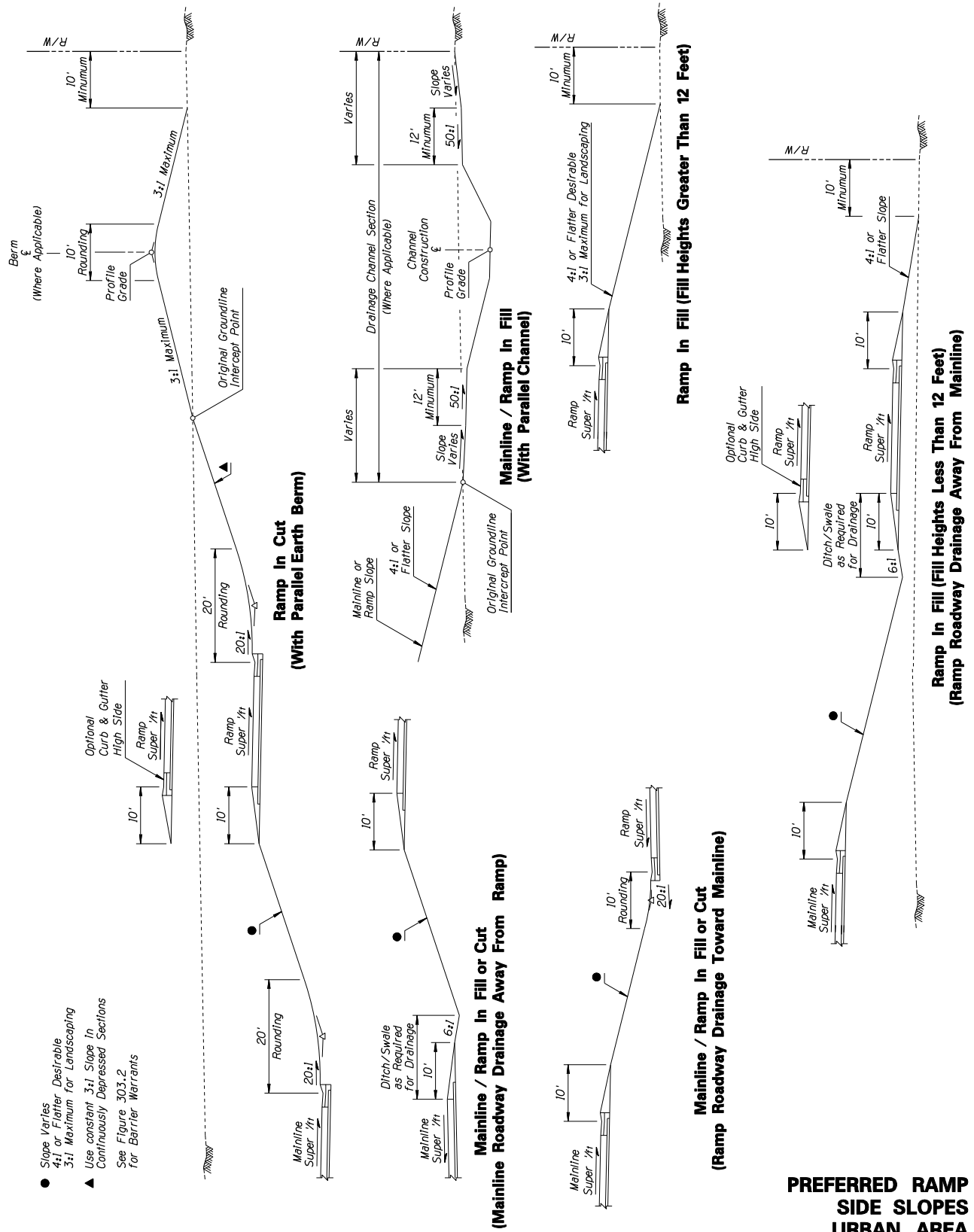

**PREFERRED RAMP SIDE SLOPES URBAN AREA**  
**FIGURE 504.4A**

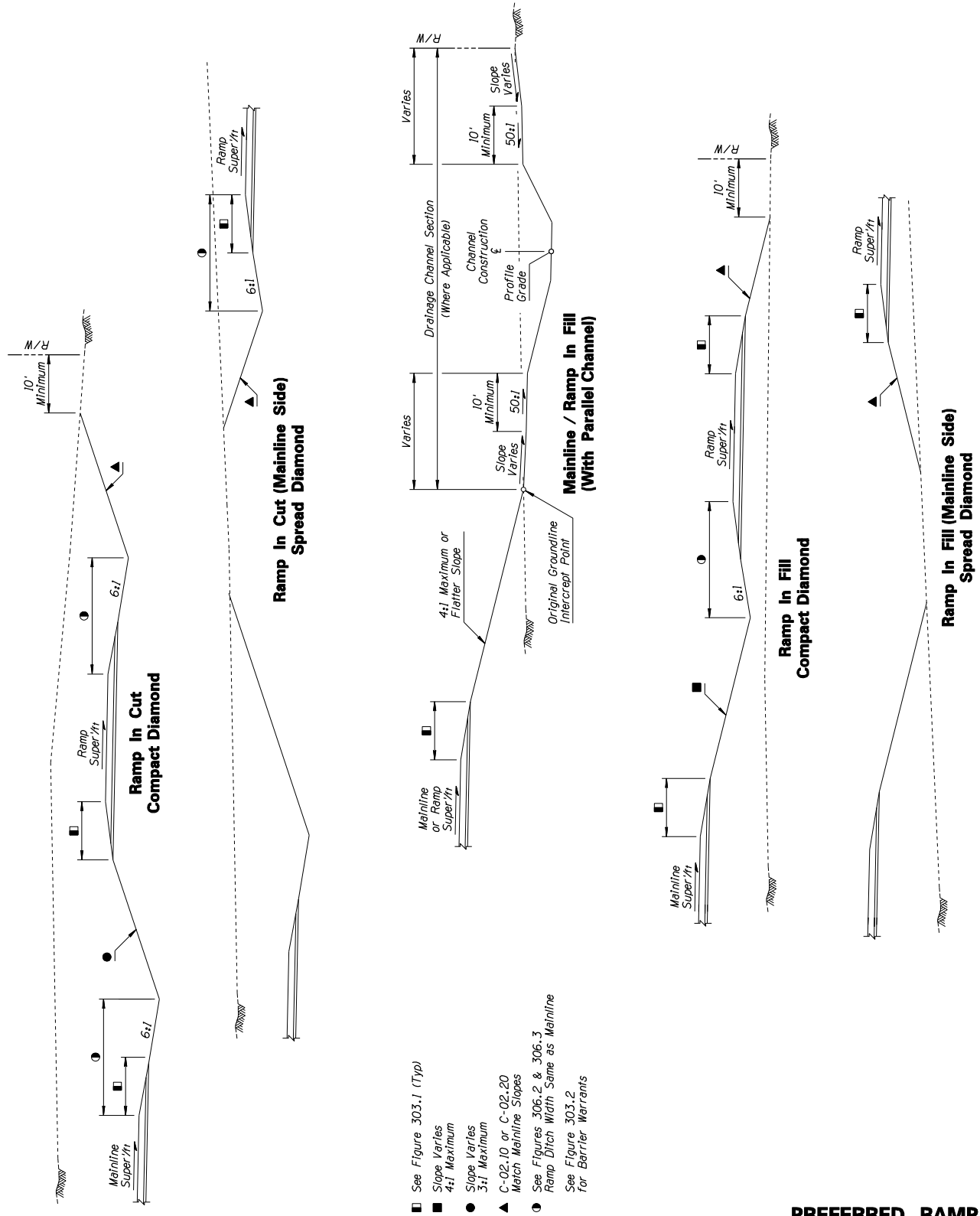

- See Figure 303.1 (Typ)
- Slope Varies
- 4:1 Maximum
- Slope Varies
- 3:1 Maximum
- C-02.10, or C-02.20
- Match Mainline Slopes
- See Figures 306.2 & 306.3
- Ramp Ditch Width Same as Mainline
- See Figure 303.2
- For Barrier Warrants

**PREFERRED RAMP SIDE SLOPES RURAL AREA**  
**FIGURE 504.4B**

## 504.5 - Ramp Width

**Ramps shall comprise one or more 12 ft lanes plus right and left shoulders of widths as shown in Table 302.4.** The number of lanes will be determined by traffic capacity requirements. Generally, two lanes will be required when the ramp design hourly volume (DHV) is 1500 passenger car equivalents or greater. Between ramp DHV's of 900 to 1500, provisions should be included in the design for future widening of the ramp to two lanes, with shoulders. Below a 900 DHV, a single lane, with shoulders, should be provided. A width to accommodate a minimum of two lanes, with shoulder widths as shown in Table 302.4, is recommended for urban directional interchange ramps. See Figure 504.5 for general layouts showing ramp widths and ramp pavement tapers for non-directional ramps.

For barriers along ramps, an additional 2 ft offset is provided to guardrail or concrete barrier including the concrete barrier on the structure. See the Design Memorandum entitled “[2 Foot Offset Distance to Roadside Barriers](#)”.

A basic 22 ft wide ramp width is adequate to provide for one-lane, one-way operation of the ramp with provision for passing a stalled vehicle at a normal level of truck traffic using the ramp (approximately 10% of design volume). At interchanges where a large number of trucks may be reasonably expected to use a loop ramp, the ramp width should be increased to accommodate the design vehicle turning path.

As discussed in [Section 503.4](#), the ramp width may be increased when practical to provide adequate sight distance through a tight horizontal curve.

Normally, when the need for increased width is located on a structure, the wider section will be carried throughout the length of the structure. When the additional width is located on grade, the pavement can be widened as required.

In providing for future widening of ramps, special care should be taken when a portion of the ramp is on structure. In such cases, consideration should be given to the initial construction of the wider structure.

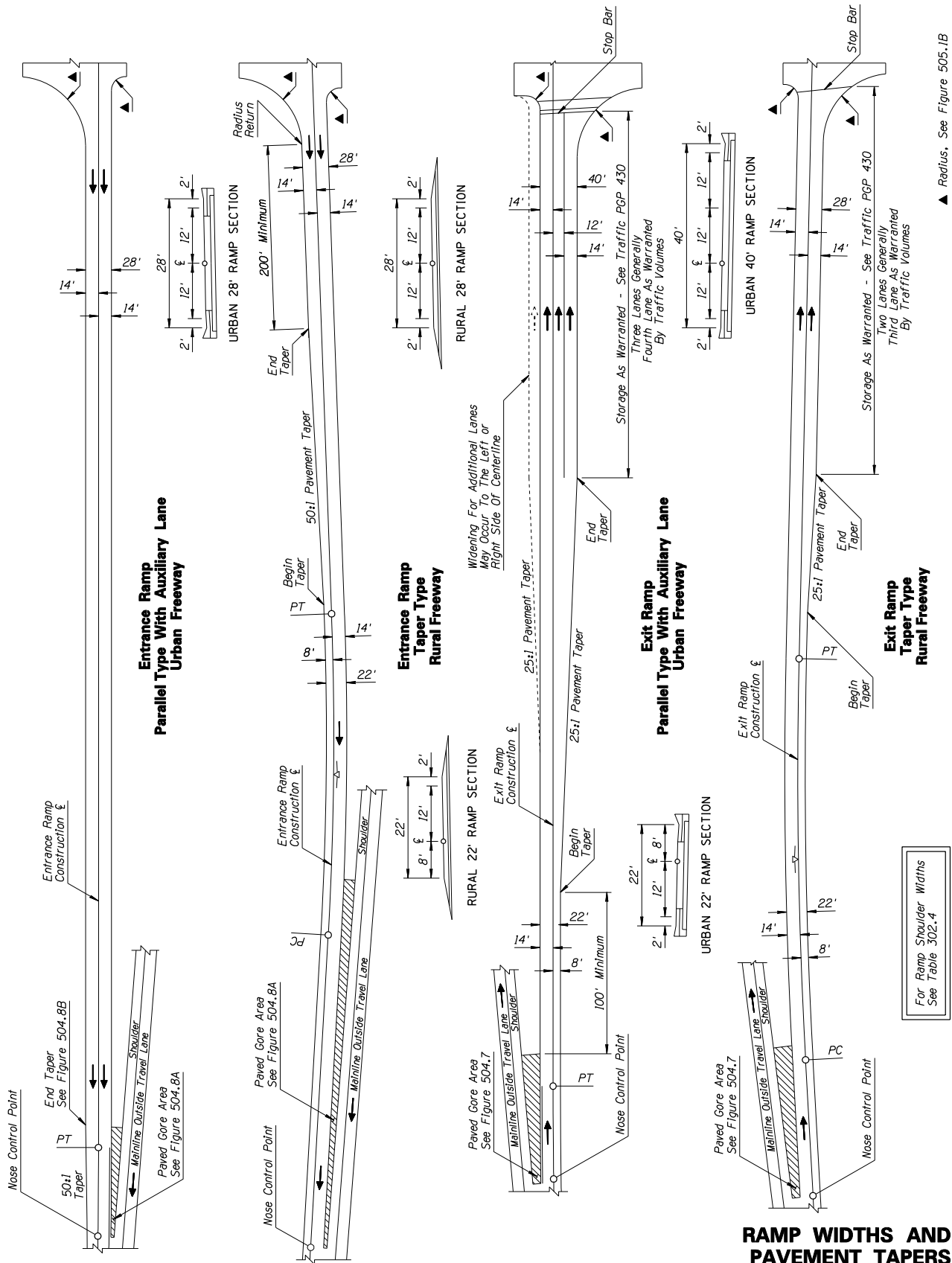

**RAMP WIDTHS AND PAVEMENT TAPERS**

**FIGURE 504.5**

### 504.6 - Ramp Length

The length of an interchange ramp is generally established by the horizontal and vertical alignment criteria discussed elsewhere in this section. Normally, these criteria will provide ramp lengths sufficient for on-ramp traffic to accelerate to the mainline speed before entering the mainline traffic lanes and for off-ramp traffic to comfortably decelerate before reaching the queue at the crossroad traffic signal.

Where on-ramp up-grades are greater than 3%, or where long traffic signal queues are expected, consideration should be given to lengthening the ramp to provide additional acceleration distance or storage length. Where ramp metering is anticipated, ramp lengths should accommodate acceleration and queue storage distances listed in the *Ramp Metering Design Guide*.

### 504.7 - Ramp Geometrics at Exit from Mainline

See [Figure 504.7](#) for the general layout of one-lane and two-lane off-ramp exits from the mainline. Exit ramps from mainline are either taper type or parallel type. Figure 504.7 provides typical layouts for one-lane and two-lane tapered and parallel exits and includes mainline auxiliary lane and end of freeway conditions.

**New or reconstructed exit ramps on the urban and “urban fringe” freeways of Metropolitan Phoenix and Tucson shall be designed as parallel type exit ramps except in the vicinity of a directional interchange where an analysis should be done to determine the preferred type.** On a case basis, freeway exit ramps in other urban areas such as Yuma, Flagstaff and Kingman should be evaluated for parallel type versus taper type exit design.

#### A) *One-lane exits.*

**Taper-type:** The taper-type exit ramp is the preferred layout for rural interchanges and may be utilized in urban areas as described above. The typical layout for the exit of a one-lane tapered off-ramp is that of a tangent departing from the mainline edge of traveled way at an angle of 4° and continuing on tangent alignment past the gore nose a distance sufficient to transition at least 0.5 of the superelevation runout length before beginning any horizontal curvature. For this case, ramp superelevation transitions should not occur on the mainline side of the gore nose. The ramp and mainline will be in the same plane from the beginning of the ramp to the gore nose. Permissible differences in cross slope across the paved gore are described in [Section 504.3](#).

**Parallel-type:** The parallel-type exit ramp is the preferred layout for urban and “urban fringe” interchanges. It provides additional length for the vehicle exiting the mainline to leave the main traffic stream and also provides a smooth geometric connection with auxiliary lanes between interchanges. The parallel exit begins with a 25:1 exit taper and creates the parallel lane in 300 ft as shown on Figure 504.7, sheet 1. The parallel lane then continues a minimum distance of 300 ft plus 0.5 of the superelevation runout length prior to entering the curve. The ramp and mainline will be in the same plane from the beginning of the ramp to the beginning of the ramp superelevation transition. The maximum difference in superelevation between the mainline and the ramp from the start of the ramp superelevation transition to the gore nose is 2% with 1%

desirable. Through the paved gore length, the maximum breakover is 5% as discussed in Section 504.3 and shown on Figure 504.7, Sheet 1.

The edge of the mainline shoulder continues until it intersects the ramp edge-of-shoulder line.

The width of gore nose and back of paved gore will be as shown in [Figure 504.7](#). The paved gore widths are measured perpendicular to the mainline. A full shoulder will be provided along the mainline at the gore nose and beyond.

**Curbed gores shall not be used.** Curbs may be introduced, as appropriate, at the back of the paved gore using the curb transition shown in the Construction Standard Drawings.



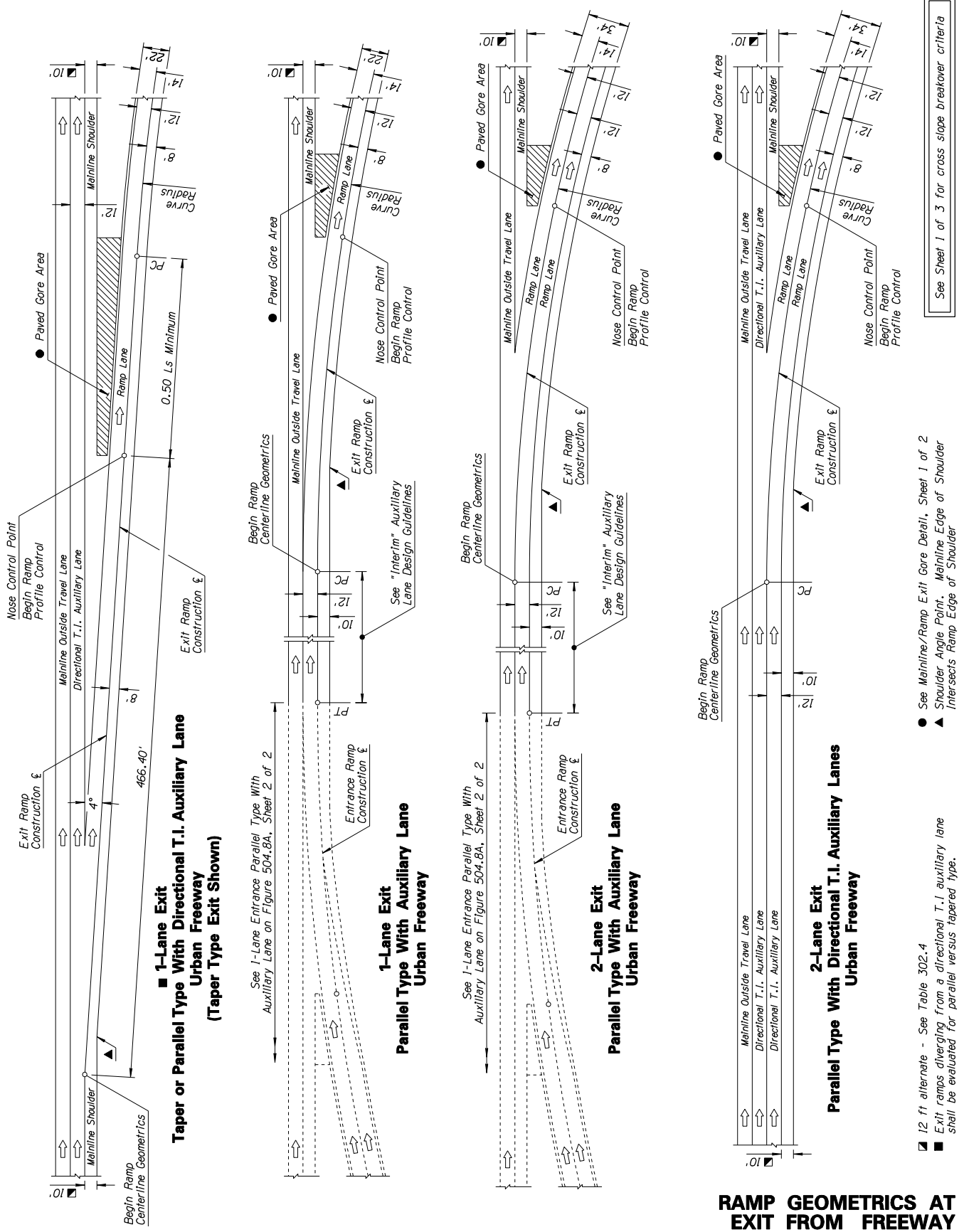

**RAMP GEOMETRICS AT EXIT FROM FREEWAY**

**FIGURE 504.7**  
Sheet 2 of 3



Where the mainline is on a horizontal curve at the beginning of an exit ramp (see [Figure 504.7, Sheet 3](#)), the 4° taper used to achieve the ramp will be replaced by a horizontal curve of approximately the same radius as that of the outer edge of the mainline traveled way and of a length such that the transition to the full ramp width would be approximately the same as would have been provided by a 4° taper from a tangent alignment. For curves flatter than 1 degree, a taper meeting the length requirements may also be used.

*B) Two-lane exits:* The alignment of the centerline of the two-lane off-ramp at its exit will be determined as described in A) above. At least 1500 ft prior to the beginning of the ramp taper, an additional 12 ft lane should be added to the mainline. A 25:1 taper should be used to introduce the additional lane. This additional lane will continue as the outside lane of the off-ramp. The additional lane will be in the same plane as the mainline from the beginning of the additional lane to the beginning of the ramp superelevation transition.

*C) End-of-Freeway Exit:* A typical end-of-freeway two-lane exit for an interim condition is shown in [Figure 504.7, Sheet 3](#). Additional widening at the exit is provided for the two-lane exit. Temporary striping of the two-lane exit is provided. With the future freeway extension, the ramp is then converted to a single lane exit by restriping and providing additional shoulder width as shown.

#### 504.8 - Ramp Geometrics at Entrance to Mainline

See [Figures 504.8A and B](#) for the general layout of one-lane and two-lane on-ramp entrances to the mainline. Ramp entrances to the mainline may be the tapered-type or the parallel-type. [Figure 504.8A](#) shows typical one-lane and two-lane tapered and parallel-ramp entrances and includes auxiliary lane applications. [Figure 504.8B](#) shows the typical ramp entrance geometrics for a dual-metered one-lane entrance. The Figures also provide the standard geometric and profile control locations for ramp design.

**All new or reconstructed entrance ramps in the urban and “urban fringe” freeways of Metropolitan Phoenix and Tucson shall be designed as parallel-type entrance ramps except in the vicinity of a directional interchange where an analysis should be done to determine the preferred type.** On a case basis, freeway entrance ramps in other urban areas such as Yuma, Flagstaff and Kingman should be evaluated for parallel type versus taper type entrance design.

*A) One-lane Entrances - Taper Type:* The taper-type of entrance is primarily used in rural locations and may also be used at urban directional-ramp entrances to auxiliary lanes (See [Figure 504.8A, Sheet 2](#)). The layout for the entrance of a one-lane taper on-ramp is that of a 50:1 taper (relative to the mainline) from the gore nose to the outer edge of the mainline traveled way. The taper will extend beyond the gore nose a distance sufficient to transition out at least 0.5 of any ramp curve superelevation.

The edge of the mainline shoulder continues until it intersects the ramp edge-of-shoulder line. The ramp and the mainline will be in the same plane from the gore nose throughout the ramp taper. Permissible differences in cross slope across the paved gore are described in [Section 504.3](#).

---

The widths of the gore nose and the back of the paved gore will be as shown in [Figure 504.8A, Sheet 1](#). A full shoulder will be provided along the mainline at the gore nose and back.

**Curbed gores shall not be used.** Any ramp and mainline curbs should be terminated at the back of the paved gore using the curb transition shown in the Construction Standard Drawings.

*B One-Lane Entrances - Parallel Type:* The parallel type of entrance is used in urban areas where ramp traffic becomes a mainline "auxiliary lane" which connects with the next exit ramp or merges into an auxiliary lane of a directional interchange (See Figure 504.8A).

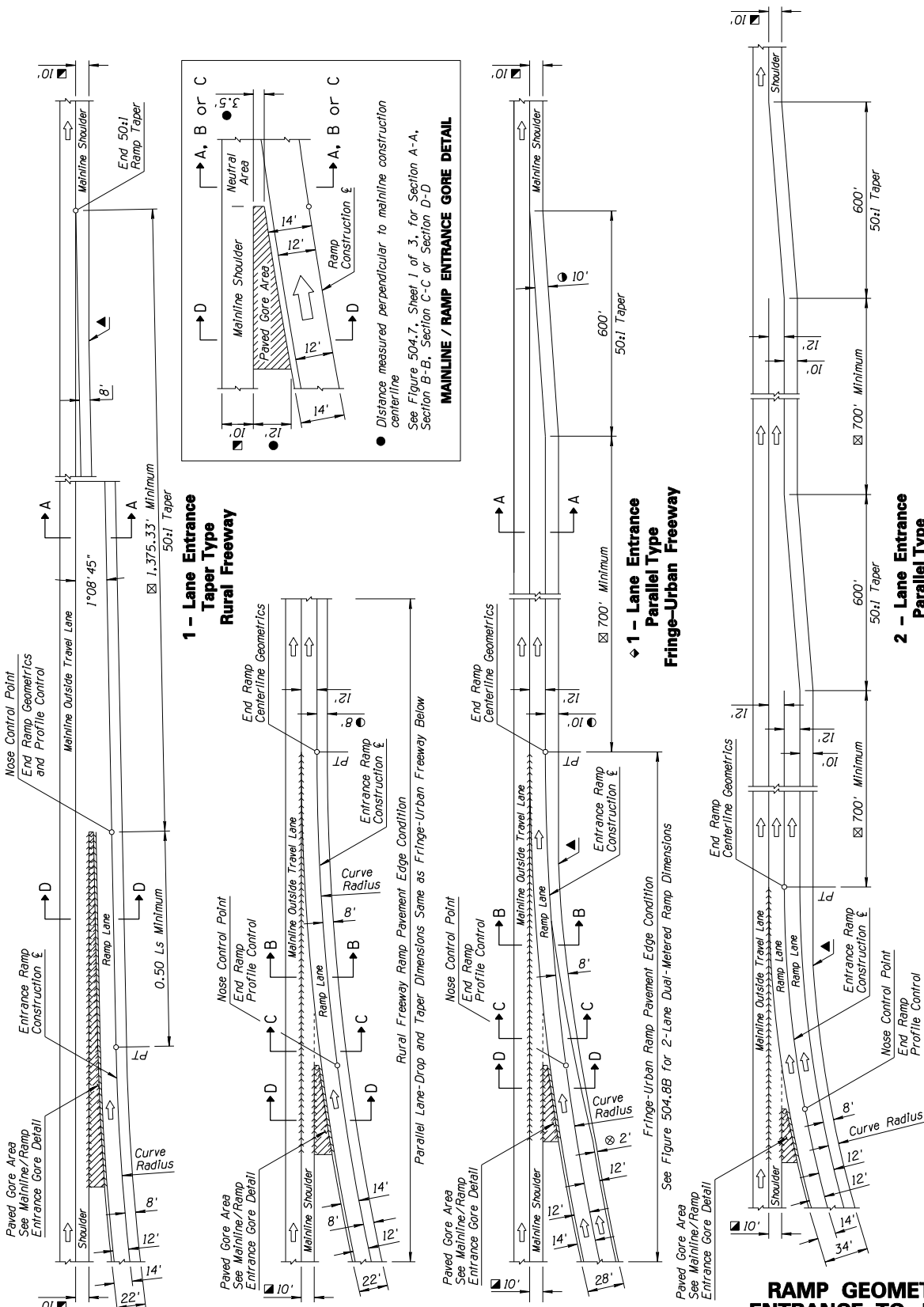

- ◆ 1 lane entrance ramps in fringe-urban and urban areas shall be designed 28 ft wide to accommodate future 2-lane metering
- ▲ Shoulder angle point. Mainline edge of shoulder intersects ramp edge of shoulder
- ☒ Distance and taper rate are minimums. See MASHTO Green Book for heavy truck traffic or steeper upgrades or both

Sections A-A, B-B, C-C & D-D for 2 Lane Entrance similar to 1 Lane Entrances, Parallel Type

- ☒ 12 ft alternate - See Table 302.4
- 2 ft right shoulder with future 2-lane metering
- 10 ft right shoulder on fringe-urban freeway with future auxiliary lane
- 8 ft right shoulder on rural freeway
- Breakover line for AC pavement only. PCCP similar, see PCCP Joint Details in Roadway Construction Standard Drawings

**RAMP GEOMETRICS AT ENTRANCE TO FREEWAY**

**FIGURE 504.8A**



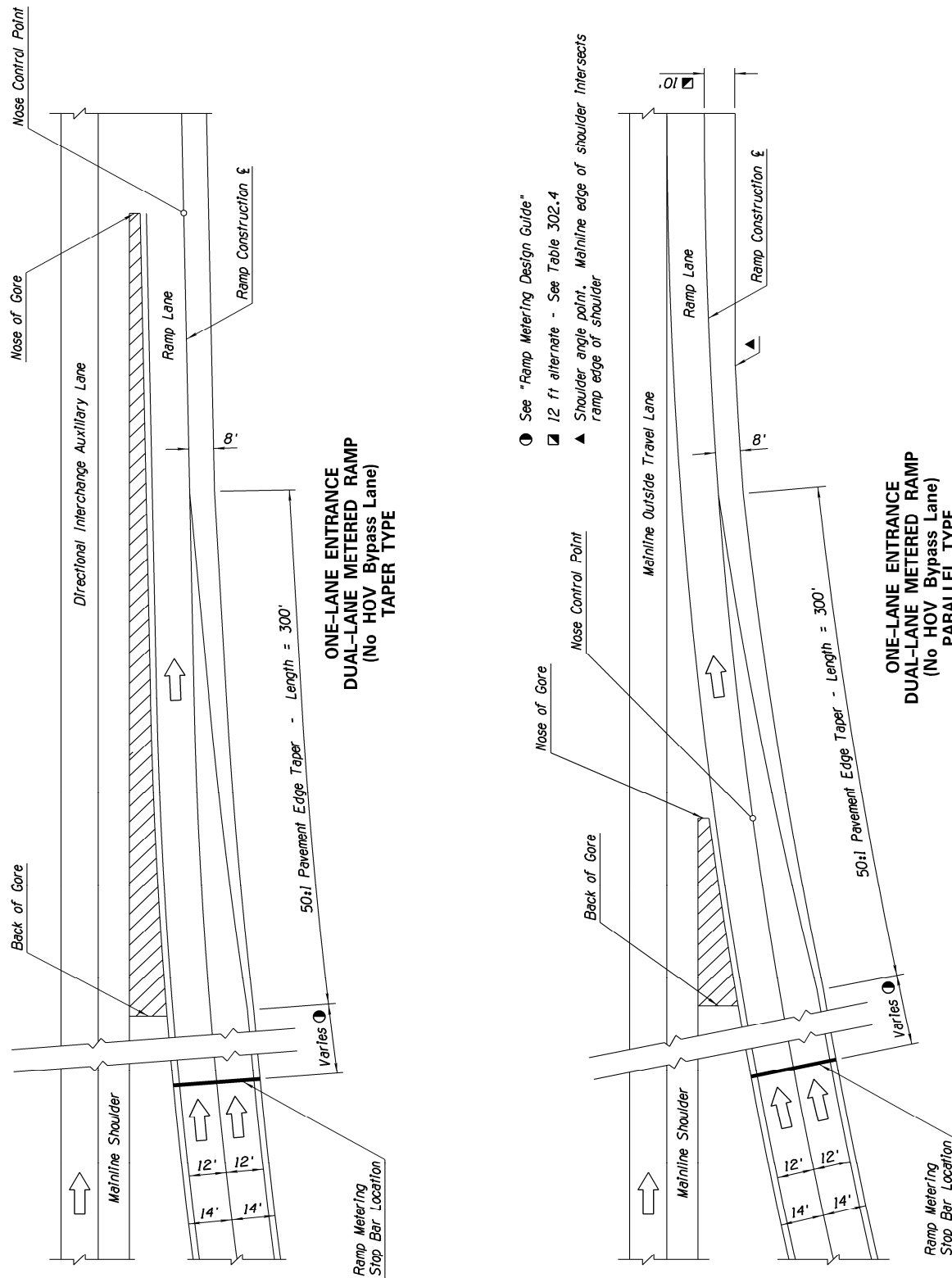

**DUAL-METERED RAMP GEOMETRICS AT ENTRANCE TO FREEWAY**  
**FIGURE 504.8B**

The layout for the entrance of a one-lane parallel on-ramp is that of a horizontal curve extending from a tangent 12 ft outside the outer edge of the normal traveled way, back of the gore nose to the remainder of the ramp horizontal geometry. Superelevation transitions should not occur along the paved gore. Ahead of the paved gore, the ramp and the mainline should be in the same plane; however, a maximum cross slope breakover of 2% (1% desirable) may be used along a line concentric to the ramp from the ramp edge of the gore nose to its intersection with the outer edge of the normal traveled way.

The widths of the gore nose and the back of the paved gore will be as shown in [Figure 504.8A](#), Sheet 1. A full shoulder will be provided along the mainline at the gore nose and back.

**Curbed gores shall not be used.** Any ramp and mainline curbs should be terminated at the back of the paved gore using the transitions shown in the Construction Standard Drawings.

**C) *One-Lane Entrance with Dual-Lane Ramp Metering:*** Within the metropolitan areas of Phoenix and Tucson and on a case-by-case basis in Yuma, Flagstaff and other urban areas, all entrance ramps (excluding system interchange directional ramps) shall be constructed to accommodate dual-lane metering of traffic onto the mainline. Ramp entrances will normally be dual-metered into one lane. The second metered lane may become an HOV bypass where approved on an individual basis. (See [Figure 504.8B](#))

Refer to the *Ramp Metering Design Guide* for ramp meter stop bar location.

The second metered lane (or HOV bypass lane when permitted) and outside shoulder will be transitioned into the left ramp lane and mainline shoulder at a 50:1 rate beginning at the back of the paved gore. Beyond this transition, the ramp will continue as described above for the taper or parallel-type entrance.

**D) *Two-Lane Entrances:*** Two-lane parallel-type entrances are shown in [Figure 504.8A Sheet 1](#) with both ramp lanes merging into the mainline outside travel lane as shown.

The ramp and the mainline will be in the same plane from the gore nose throughout the merging of the ramp and the mainline. Permissible differences in cross slope across the paved gore are described in [Section 504.3](#).

**E) *Two-Lane Directional Entrance Ramps*** The desirable method for distributing a two-lane directional entrance ramp into the mainline auxiliary lane is shown in [Figure 504.8A, Sheet 2](#).

### **504.9 - Mainline Auxiliary Lanes**

Within the metropolitan areas of Phoenix and Tucson and all other urban/suburban areas throughout the state, mainline auxiliary lanes should be provided on controlled-access highways between ramp entrances and exits of nominal 1 mile interchanges. When the distance between interchanges is greater than 1.5 miles, or when collector distributor roads are used, the operational effectiveness of such auxiliary lanes should be confirmed by a traffic analysis before being incorporated in the interchange design.

The geometric design of the ramp entrances and exits for the auxiliary lanes should conform in general to [Figures 504.7](#) and [504.8A](#) and [B](#). The design configuration of the ramps and the auxiliary lane should be based upon a complete operational analysis including traffic volumes, weaving lengths, acceleration/deceleration requirements and operational speeds.

If the distance between the entrance and exit ramp noses is less than 1200 ft, the auxiliary lane should be continued past the exit ramp nose a distance of at least 500 ft and then dropped at a 50:1 taper.

## **505 - Ramp/Crossroad Design**

### **505.1 - Diamond Ramp Geometrics at Crossroad Intersections**

Except as discussed otherwise in this section, the guidelines presented in [Chapter 400](#) should be followed in the design of diamond ramp intersections with crossroads. As with other intersections, the geometric design of a ramp/crossroad intersection should be based upon the turning and through traffic volumes. Careful coordination with the Traffic Engineering Group is required to provide a well-functioning intersection.

The distance between the two ramp/crossroad intersections at a diamond interchange is also dependent upon the turning and through traffic volumes at the interchange. The distance between the intersections is used for storage of vehicles turning left from the crossroad to the ramps. Depending on the left-turn volumes, additional storage may be required external to the interchange, i.e., on the crossroad approaches to the interchange.

For planning purposes, the ramp/ crossroad intersections may be assumed to be spaced 400 ft apart on compact diamonds and 650 ft apart on spread diamonds.

The more common types of ramp/crossroad intersections are presented in the following subsections. Their descriptions and illustrations are based on urban conditions. The basic criteria are equally applicable to rural conditions; however, the number of lanes shown may not be required to meet the traffic demands of the interchange.

A) *Ramps with Frontage Roads:* The typical layout for a ramp/ frontage road intersection with a crossroad is shown in [Figure 505.1A](#).

The frontage road should be on tangent alignment between the gore noses of the exit and entrance ramp. The frontage road should have a near perpendicular intersection with the crossroad.

The gore nose for the juncture of the off-ramp and the frontage road should be located not less than 550 ft from the crossroad curb. The actual distance to be used should be based on the weaving and storage requirements for the ramp and frontage road traffic. The off-ramp width and the frontage road width should be provided at the gore nose. The widths of the paved gore at front and back will be as shown in [Figure 505.1A](#). Beyond the gore nose, the right ramp shoulder should be merged with the adjacent frontage road lane to provide a 12 ft lane.

The location of the angle point at the departure of the on-ramp from the frontage road should be as required by a traffic analysis and the site conditions but at least 260 ft from the crossroad right-turn lane radius return. The on-ramp width at the nose will provide for two-12 ft lanes with 2-ft shoulders. The full frontage road width will also be provided at the nose. The widths of the on-ramp/frontage road paved gore at front and back will be as shown in [Figure 505.1A](#). Frontage road lane and shoulder widths are in accordance with [Figure 309A](#). Before the gore nose, the on-ramp should depart from the frontage road on a tangent alignment at a minimum angle of 2°00' and a maximum angle of 4°30'.

The required turning movements and any necessary turning bays at the intersection of the ramp/frontage roads with the crossroad should be determined through a traffic analysis. Raised medians should be provided on the crossroad approaches to the intersection to assist in guiding traffic through the intersection.

The right-turning radius from crossroad to ramp/frontage road is normally 75 ft but may be individually designed to accommodate local conditions by utilizing the design vehicle turning templates and a multi-centered curve. The left-turning radius from crossroad to ramp is normally 15 ft.

The ramp and frontage road cross slopes at the gore areas should be in accordance with [Section 504.3](#).

#### *B) Ramps without Frontage Roads*

[Figures 505.1B](#) (2 sheets) show typical ramp/crossroad intersections for 4-lane and 6-lane crossroads. The 6-lane section shows the intersection having curb and gutter and the 4-lane section without curb and gutter. The predesign scoping documents will determine the need for curb and gutter and specify lane and shoulder widths for a particular intersection depending upon the local environment.

The design of an intersection of freeway ramps and a crossroad should be based on the guidelines presented in [Chapter 400](#) and an analysis of the design year traffic volumes and movements.

The angle of intersection of an exit ramp or an entrance ramp with the crossroad should be as close to perpendicular as practical. **The intersection angle shall not deviate from a right angle by more than 15 degrees.**

Exit and entrance ramps should not intersect the crossroad centerline at the same point. The intersection should be as compact as possible to minimize traffic conflicts and to provide an efficient layout for traffic signals. The center lane of the off-ramp and the dedicated left-turn lane of the on-ramp should line up at the crossroad intersection to permit the through movement of the center lane and prohibit a through movement from the dedicated left-turn lane.

The required turning movements and necessary turning bays at the intersection of the ramp with the crossroad should be determined through a traffic analysis. Raised medians should be provided on the crossroad approaches to the intersection to assist in guiding traffic through the intersection. [Figures 505.1B](#) show the design vehicle (WB-67 and WB-50) turning template applications to determine the locations of raised island noses for a freeway condition.

The radius of curb or pavement returns should be as required for the design vehicle appropriate for the interchange (see [Chapter 400](#)) but not less than shown in [Figures 505.1B](#). As an alternate to the 75 ft radius, multi-centered curves may be utilized with the design vehicle template when needed to meet local conditions.

### *C Ramp/Crossroad Curb and Gutter Layout and Transitions*

[Figures 505.1C](#) (2 sheets) show the layouts for curb and gutter transitions at the entrance and exit ramp intersections with the crossroad. Typical barrier and sidewalk transitions are also shown for alternate barrier treatments on the bridge

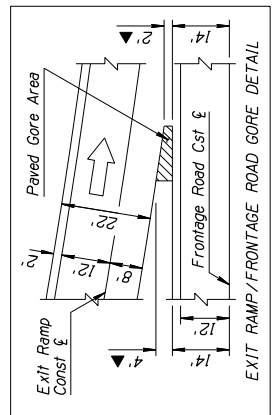
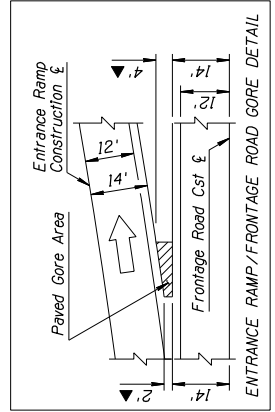
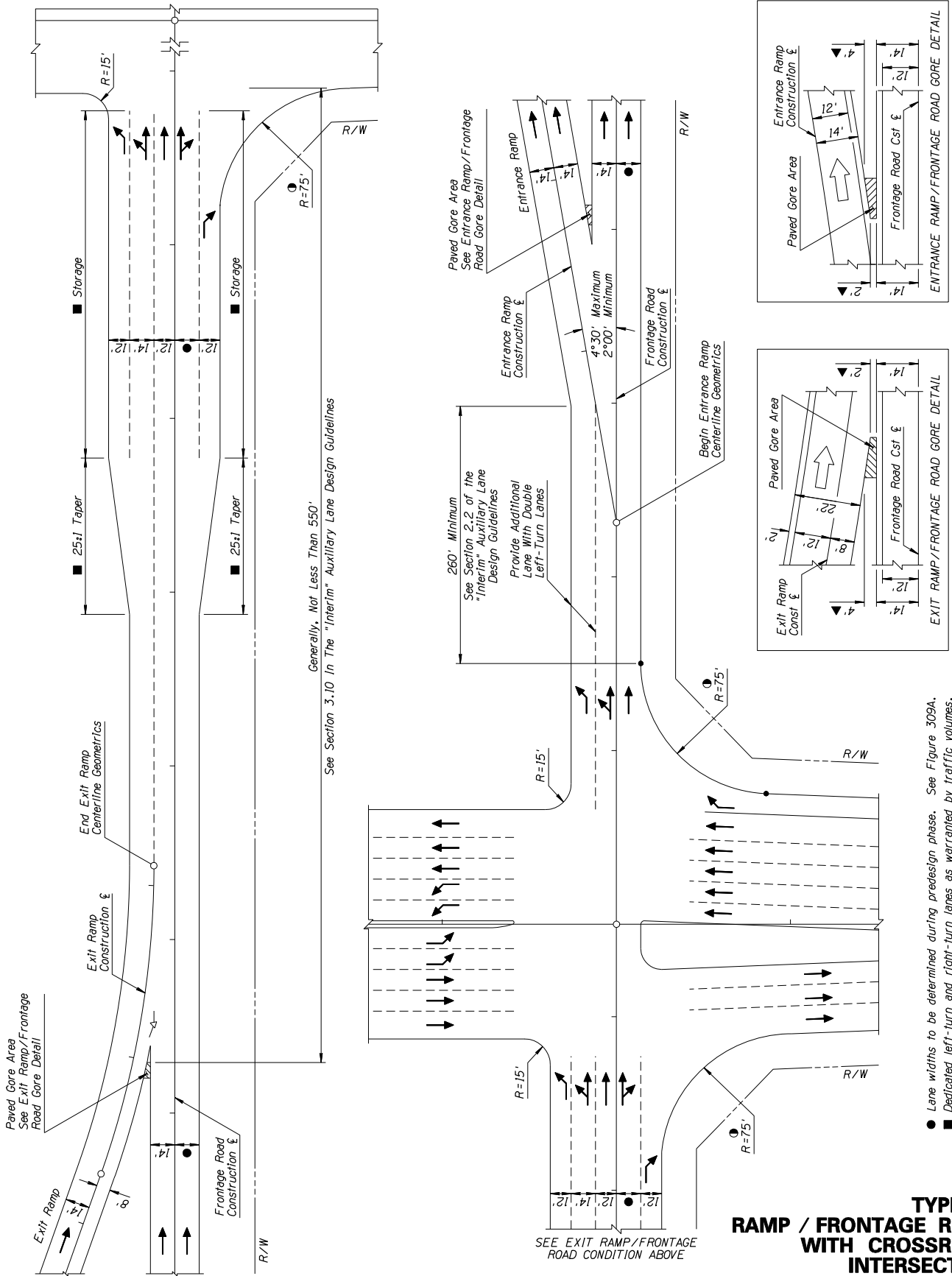

- Lane widths to be determined during pre-design phase. See Figure 309A.
- Dedicated left-turn and right-turn lanes as warranted by traffic volumes.
- Smaller radius or multi-centered curves based on minimum turning path of the required design vehicle are acceptable.

**TYPICAL RAMP / FRONTAGE ROAD WITH CROSSROAD INTERSECTION**  
**FIGURE 505.1A**

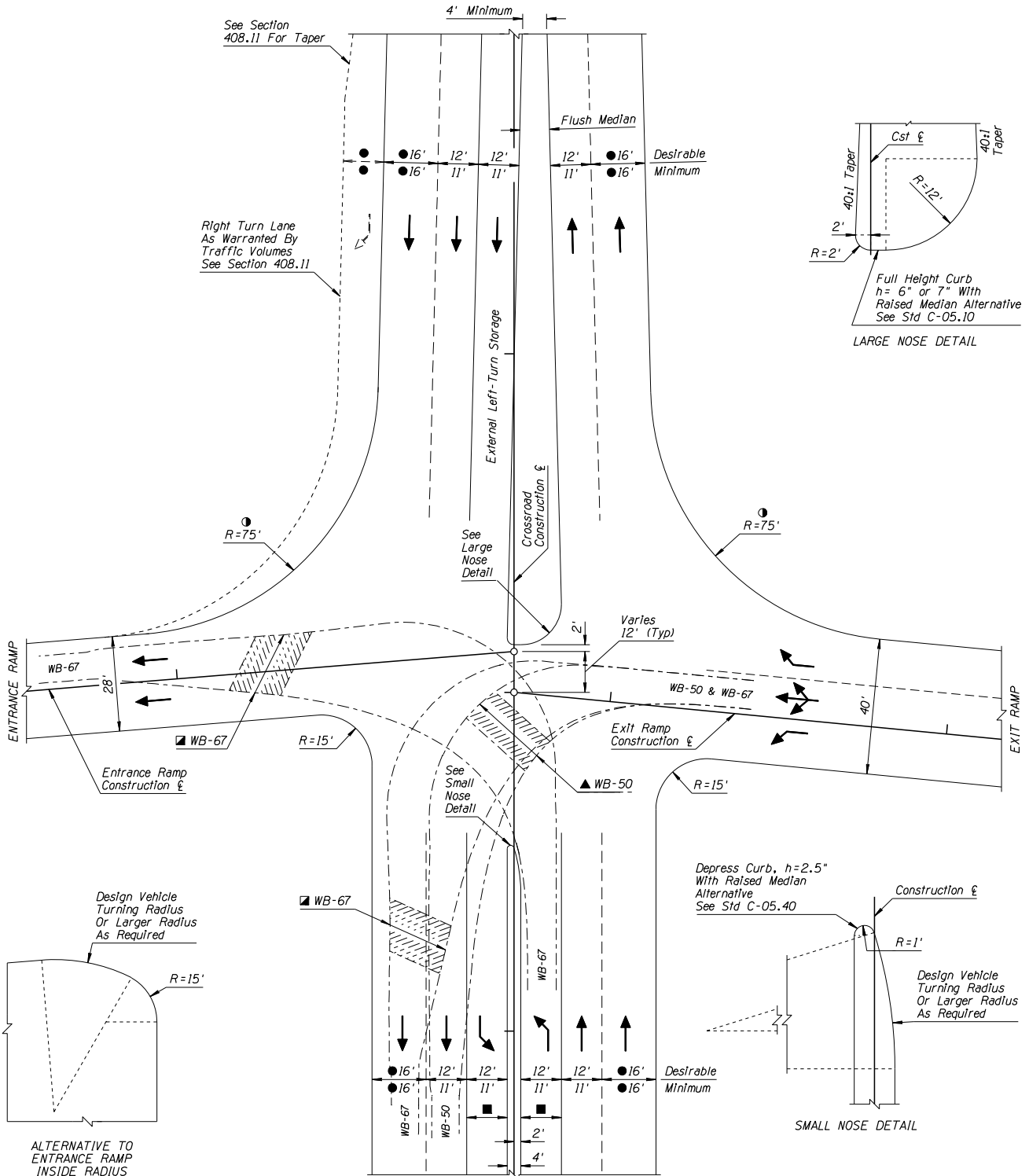

- Outside lane width to be determined during the predesign phase. See Section 301.3 and ADOT Bicycle Policy for lane width criteria.
- An additional left-turn lane in each direction may be required if warranted by traffic volumes.
- ▲ Use WB-50 from the exit ramp center lane to the crossroad innermost through lane to locate the end of the small median island.
- ▣ Use WB-67 from the exit ramp center lane to the crossroad outermost through lane to verify the minimum turning path for the Interstate Semitrailer. WB-67 is also used from the crossroad left turn lane to the entrance ramp outside lane to locate the inside ramp/crossroad roadway edge line.
- ① Smaller radius or multi-centered curves based on minimum turning path of the required design vehicle are acceptable.

Non-Curb & Gutter With AC Pavement Shown  
 For Curb & Gutter With PCC Pavement  
 See Figure 505.1B, Sheet 2 of 2

**4 - LANE  
 CROSSROAD / RAMP  
 INTERSECTION**  
**FIGURE 505.1B**  
 Sheet 1 of 2

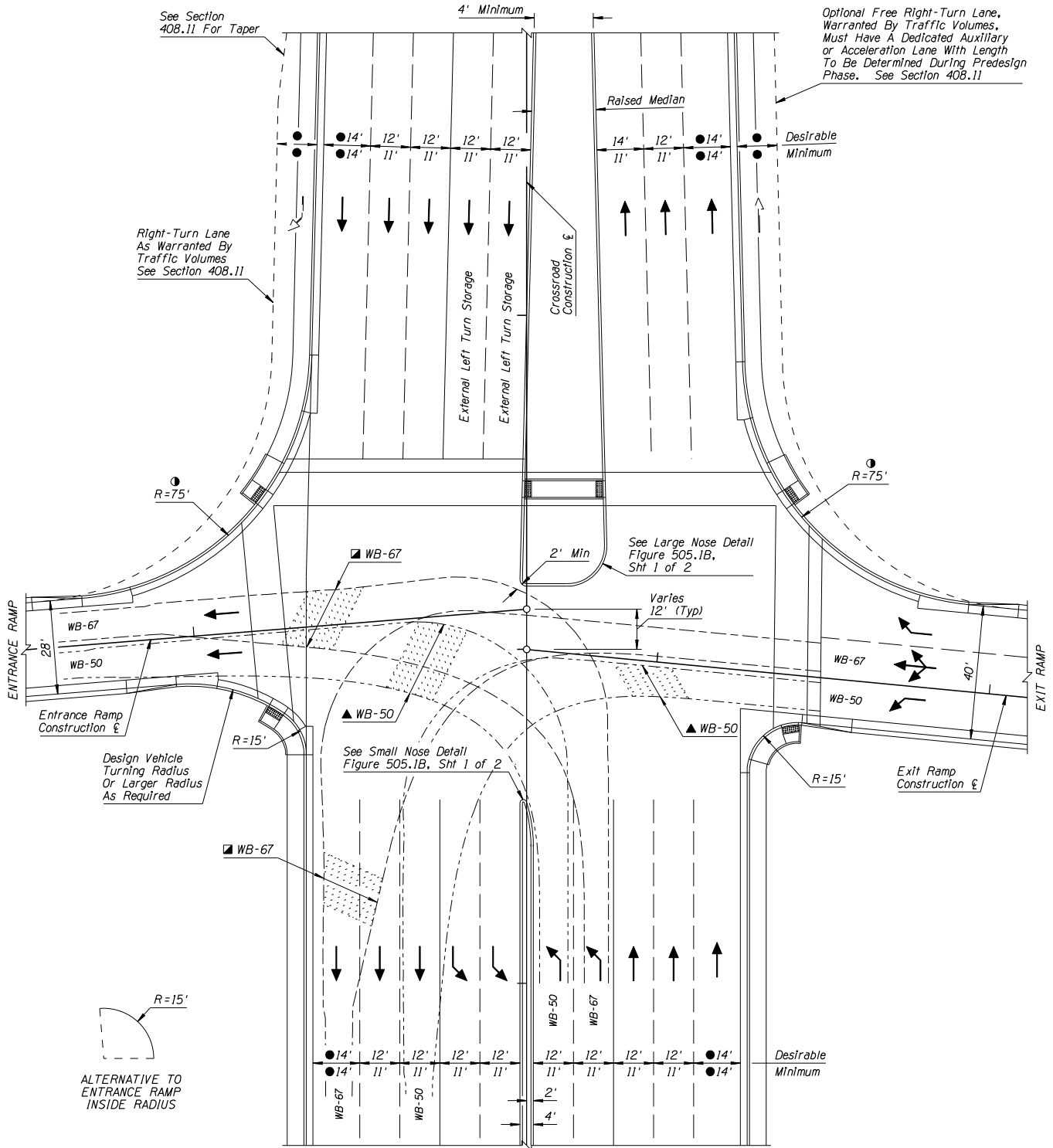

- Outside lane width to be determined during predesign phase. See Section 301.3 and ADOT Bicycle Policy for lane width criteria.
- ▲ Use WB-50 from the exit ramp inside lane to the crossroad innermost through lane to locate the end of the small median island. WB-50 is also used from the crossroad inside left turn lane to the entrance ramp inside lane to locate the end of the small median island and to locate the inside ramp/crossroad roadway edge line.
- Use WB-67 from the exit ramp center lane to the crossroad outermost through lane to show the minimum turning path for the Interstate Semitrailer. WB-67 is also used from the crossroad outside left turn lane to the entrance ramp outside lane to locate the crossroad large median island.
- Smaller radius or multi-centered curves based on minimum turning path of the required design vehicle are acceptable.

Curb & Gutter With PCC Pavement Shown For Non-Curb & Gutter With AC Pavement See Figure 505.1B, Sheet 1 of 2

**6 - LANE  
CROSSROAD / RAMP  
INTERSECTION**  
**FIGURE 505.1B**  
Sheet 2 of 2

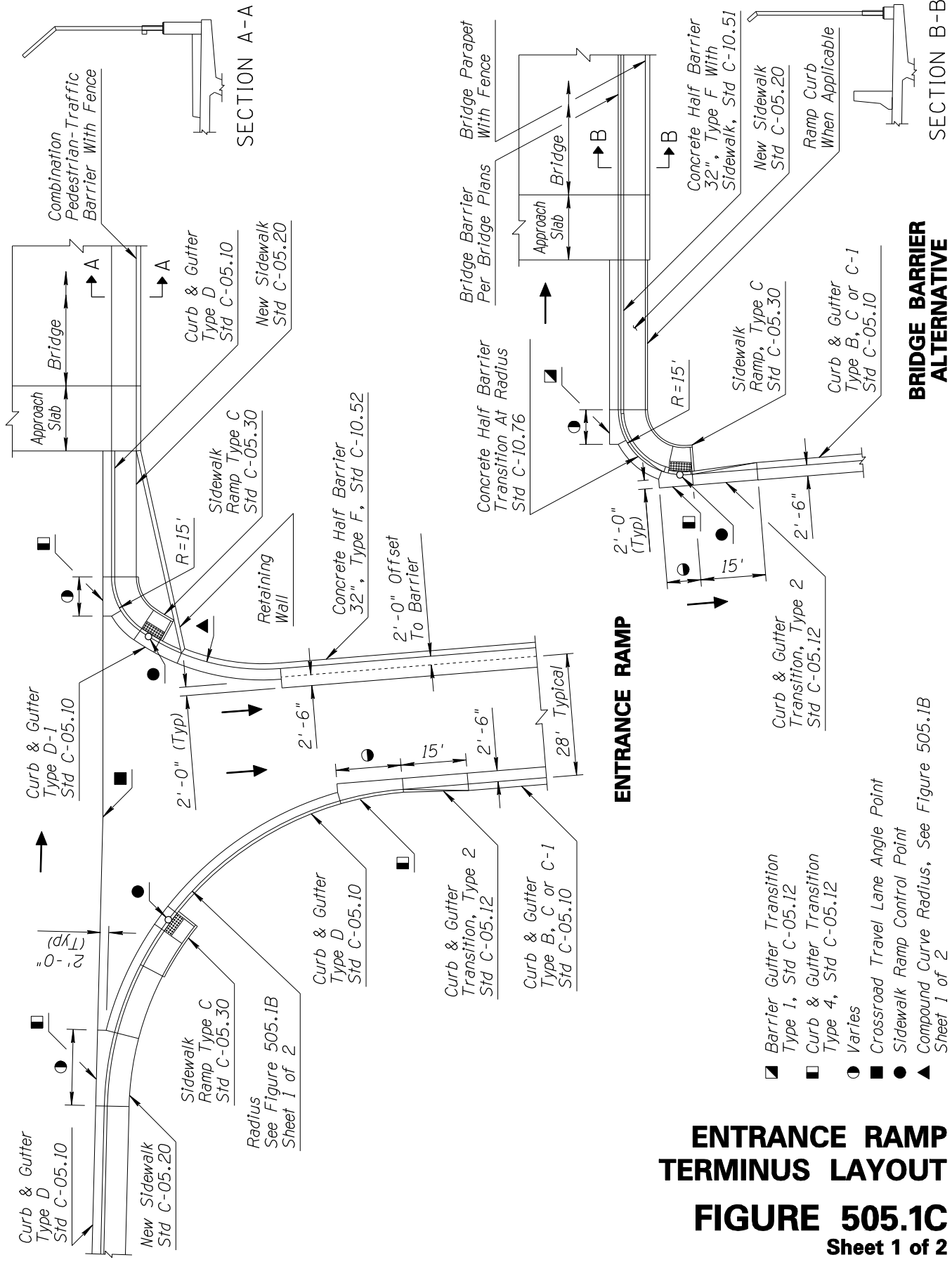

**ENTRANCE RAMP TERMINUS LAYOUT**  
**FIGURE 505.1C**  
 Sheet 1 of 2

**BRIDGE BARRIER ALTERNATIVE**



## 505.2 – Single Point Urban Interchange

The typical layout for a SPUI is shown in [Figure 505.2](#). Except as discussed otherwise in this section, the guidelines presented in [Chapter 400](#) should be followed in the design of a SPUI.

As with other intersections, the geometric design of a SPUI should be based upon the design turning and through traffic volumes. Careful coordination with the Traffic Engineering Group is required to provide a well-functioning intersection.

Vehicle turning templates should be utilized to check all turning movements and to determine the pavement and lane widths required. The right-turning movements must be individually designed to provide for the design vehicles. As shown in [Figure 505.2](#), additional width for truck turning is provided and is normally striped out to preclude use by passenger vehicles. A minimum separation of 6 ft and desirably 10 ft should be provided between the turning paths of the opposing left-turning vehicles. Increased lane widths of 15-16 ft are used for the dual left turns to accommodate the design vehicles. Compound curves for the turning movements through the interchange are preferred to reduce structure costs. The left turn from ramp to crossroad has a compound curve from short radius to larger radius. The longer radius precedes the shorter radius in the left-turn movement from crossroad to ramp. The ratio of the compound curve radii in the direction of traffic from larger radius to smaller radius should not exceed 2:1.

Typically, raised islands are used to channelize traffic through the SPUI ramp intersections with the crossroad. Islands should meet the guidelines in [Chapter 400](#).

The final geometry of the intersection is determined by the site conditions. It is desirable that crest vertical curvature across the intersection be minimized to allow adequate intersection sight distance across the crossroad from stop bar to stop bar. This will help minimize the potential for vehicles to enter the intersection late and become trapped or cause conflicts.

Movement of pedestrians through the SPUI should be carefully considered since the pedestrian is required to move through several signal phases. It is recommended that pedestrian crossings of the crossroad be located away from the SPUI and routed to the nearest cross street.

The AASHTO Green Book, NCHRP Report 345, and other reference materials provide additional guidance on SPUI design.

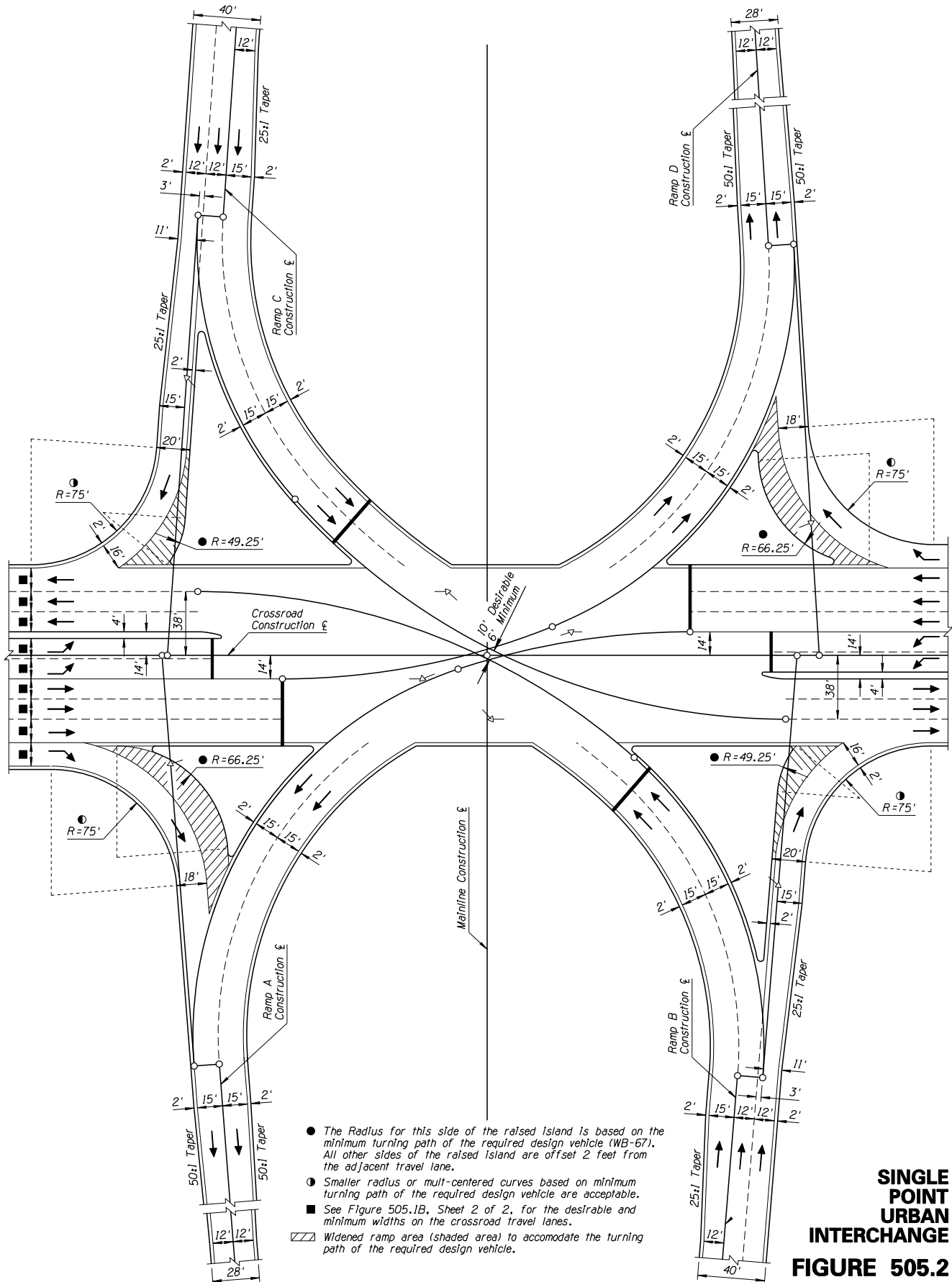

- The Radius for this side of the raised Island is based on the minimum turning path of the required design vehicle (WB-67). All other sides of the raised island are offset 2 feet from the adjacent travel lane.
- Smaller radius or multi-centered curves based on minimum turning path of the required design vehicle are acceptable.
- See Figure 505.1B, Sheet 2 of 2, for the desirable and minimum widths on the crossroad travel lanes.
- ▨ Widened ramp area (shaded area) to accommodate the turning path of the required design vehicle.

**SINGLE POINT URBAN INTERCHANGE**  
**FIGURE 505.2**

### 505.3 - Crossroad Transitions

Generally, the number of crossroad lanes provided at an intersection with interchange ramps is greater than for the typical section for the crossroad approaches to the interchange; i.e. away from the intersection. The number of lanes to be provided is based upon the design year through and turning traffic volumes and coordination with local government agencies to be compatible with their adopted typical sections.

A typical layout for an urban crossroad intersection with diamond interchange ramps is shown in [Figure 505.3](#). The lane transition rates and tapers (e.g. 40:1 tapers) shown in [Figure 505.3](#) may differ from the criteria given in [Chapter 400](#). Where differences occur, the data in [Figure 505.3](#) should be used.

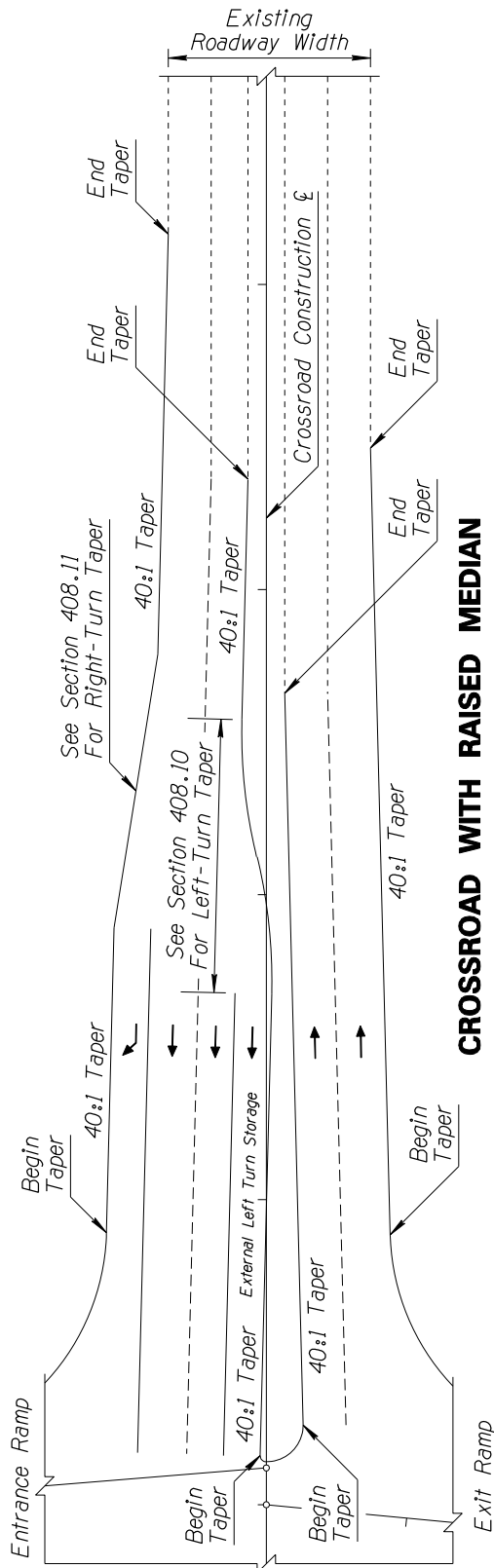

**CROSSROAD WITH RAISED MEDIUM**

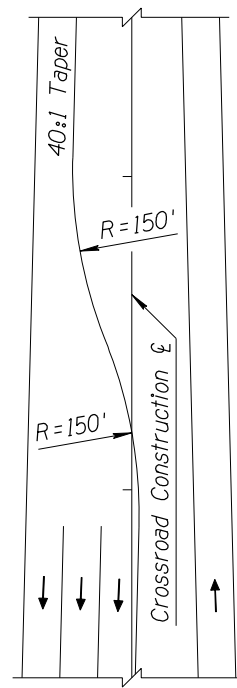

**DUAL LEFT-TURN TAPER**

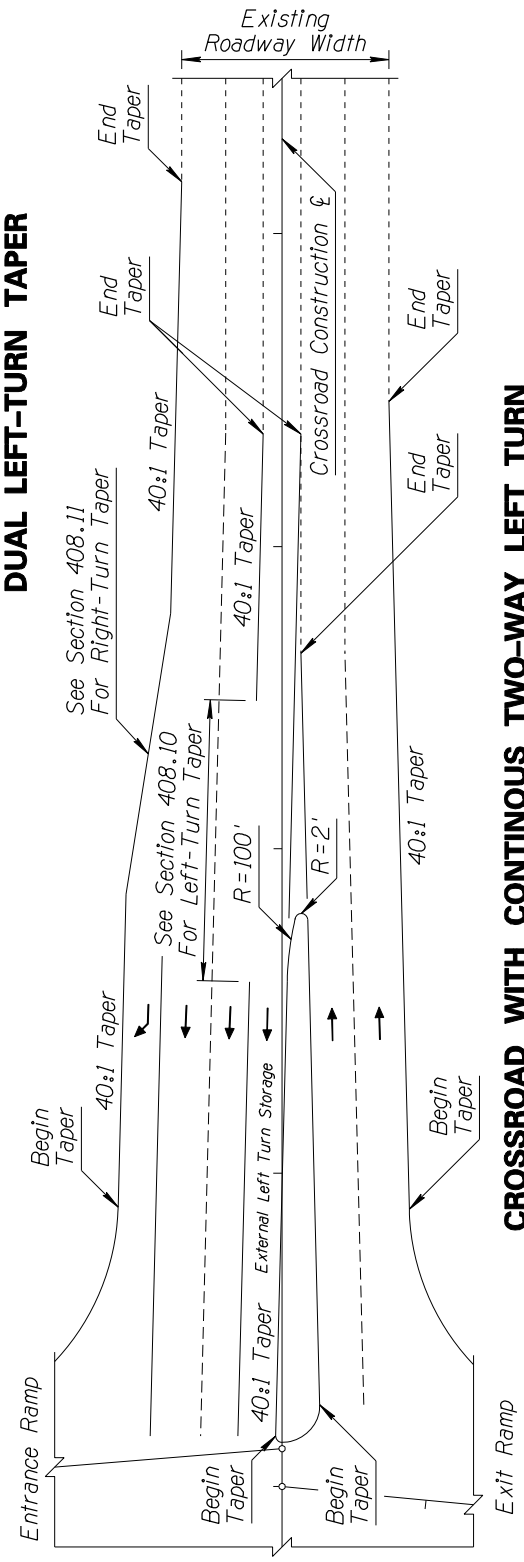

**CROSSROAD WITH CONTINUOUS TWO-WAY LEFT TURN**

**TYPICAL CROSSROAD TRANSITION AT RAMP INTERSECTION**  
**FIGURE 505.3**

### **506 - Access Control**

Adequate access control is essential to the safe and efficient operation of traffic interchanges. Access control limits should be as long as practicable to help minimize queue spillback, stop-and-go travel, heavy weaving volumes, and poor signal progression. The access-control line for a fully access-controlled freeway will be broken at its intersection with the crossroad at an interchange. **Full access control shall extend along the crossroad a minimum of 660 ft beyond the end of exit ramp radius returns. From entrance ramps, full access control shall extend along the crossroad a minimum of 330 ft beyond the radius return. Between 330 ft and 660 ft from the entrance ramp returns, access along the crossroad shall be limited to right-in / right-out only.** The nearest signalized intersection should be located at least 2640 ft from any ramp intersection unless existing conditions dictate otherwise, or unless an operational analysis can justify a closer proximity. (See [Figure 506A.](#))

In urban areas with existing development, it may sometimes be difficult to obtain minimum access control distance along the crossroad. Right-of-way acquisition for the access control must be considered and evaluated based upon land ownership and existing access. The designer should work closely with the Right-of-Way Group to determine the practicality of obtaining the minimum access control. If the minimum is not practical to obtain, as much distance as practical should be obtained, however, an absolute minimum of 100 ft should be obtained and any access provided within the remaining distance to 660 ft should be accessed only by right-in / right-out traffic.

**When frontage roads join the ramps at an interchange with a crossroad, the access control shall be broken across the frontage road from the back of the ramp paved gore to the outside of the frontage road. The control of access shall continue along the outside of combined ramp and frontage road to the intersection with the crossroad and extend along the crossroad as described above.** (See [Figure 506B.](#))

Pre-existing access to a frontage road from abutting property may remain except within 100 ft of the intersection curb (or pavement) return or within 100 ft of a point opposite the ramp/frontage road gore nose when not feasible to obtain access rights. The impacts of retaining pre-existing property access to a frontage road in the turning lanes at an intersection should be carefully studied in conjunction with the Traffic Engineering Group and the Right-of-Way Group. The acquisition of access rights may be required in some cases.

Access control lines are shown on the roadway plans.

Access control dimensions and actual location are shown on the right-of-way plans.



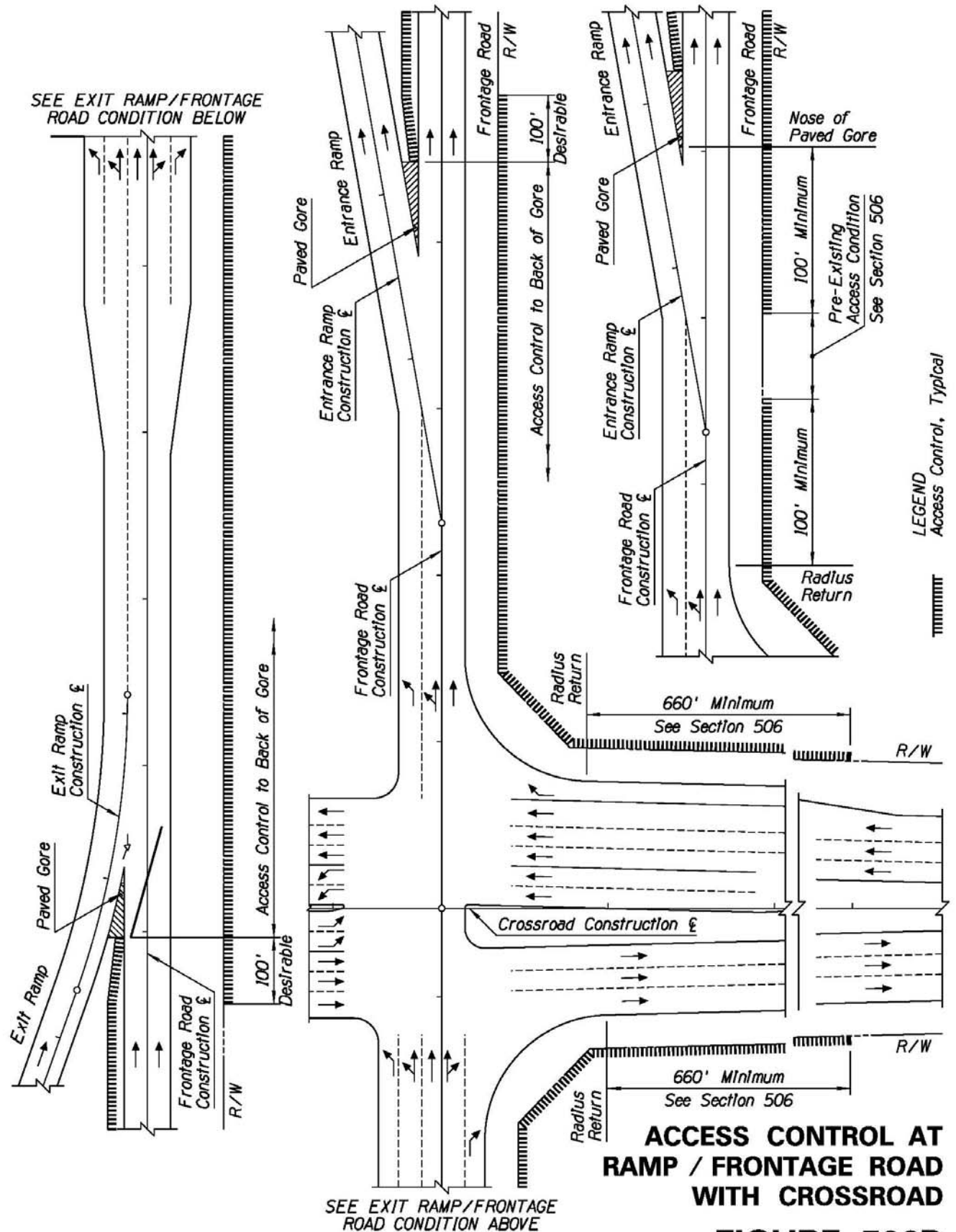

**ACCESS CONTROL AT RAMP / FRONTAGE ROAD WITH CROSSROAD**  
**FIGURE 506B**

## CHAPTER 600

### HIGHWAY DRAINAGE DESIGN

#### 601 - General

##### 601.1 - Design Philosophy

The objective of highway drainage design is to provide the necessary highway drainage facilities which allow the public the appropriate use of the highway during times of significant runoff and which minimize the potential for adverse effects on adjacent property and existing drainage patterns.

Toward this end, the goal in highway drainage design is to minimize off-project impacts while maintaining an acceptable frequency of protection for the highway at near optimal construction as well as maintenance cost.

Generally, the minimum drainage facility would be one which perpetuates the existing drainage conditions (for the 100-year event) as nearly as possible. Conditions during more frequent events (2 year and/or 10 year) may also require evaluation. However, the drainage design should provide near optimal facilities considering all life cycle costs, rather than merely meeting minimum requirements.

Highway drainage is one of the major costs of a highway facility -- not only in original construction cost but also in maintenance costs. This is particularly true in urban areas, where the larger runoff volumes, the greater potential damage to adjacent property by flooding and the lack of natural waterways to receive runoff require costly collection and underground conveyance systems. The highway designer should be cognizant of the drainage issues associated with the project and should anticipate potential solutions to these issues.

On projects involving other than the most ordinary drainage issues, it is essential that drainage design progress ahead of the roadway design. The effect that drainage features may have on right-of-way, utilities and roadway geometrics must be established early in the design process in order to avoid inefficient designs or costly last-minute plan modifications.

Drainage does not typically follow project limits; therefore, coordination is required between projects and/or corridors as well as phasing between existing and new construction.

##### 601.2 - Design Guides

This chapter is not a textbook on drainage design nor is it a substitute for fundamental engineering knowledge or experience in drainage design.

This chapter should be used in conjunction with the AASHTO Highway Drainage Guidelines, the series of FHWA Hydraulic Publications, the ADOT Hydrology Manual<sup>1</sup> and ADOT Hydraulics Manual<sup>2</sup>.

<sup>1, 2</sup> – See page 600-33 of this Chapter for references listing.

Drainage design for a highway project comprises a watershed study, a hydrologic analysis, a drainage structure type, size and location study, cost analyses, hydraulic design, and sediment and scour analyses. The effects of the highway on the existing drainage pattern, the potential flood hazards, as well as the effect of floods on the highway should be assessed in the design process.

When determining the specific drainage design criteria appropriate for each project, a range of concerns must be considered including drainage law, regulations of public agencies, statutes, codes and ordinances, and good engineering practice. The drainage design criteria should be established during the concept development phase of the project. The criteria should identify such items as the hydrology method to be used, the design storm frequency to be accommodated, the allowable spread of water on the pavement to be tolerated at the specified storm frequency, and any other pertinent hydraulic data which are design controls for the project.

The design criteria should be commensurate with the relative importance of the highway, the potential for damage to adjacent property, and the associated risks.

## **602 - Legal and Statutory Requirements**

### **602.1 - General**

**Drainage designs shall comply with all applicable Federal and State statutes and regulations.**

### **602.2 - Corps of Engineers -- "404" Permits**

"Section 404" of the Federal Water Pollution Control Act Amendments of 1972 and revised Clean Water Act of 1977 requires, among other things, a "404" permit for the placement of embankments, bank protection, or structures into the waters of the United States. The U.S. Army Corps of Engineers has been given the regulatory responsibility to implement the requirements of these acts and to develop appropriate regulations.

In administering the program, the Corps has established two kinds of permits that primarily apply to transportation projects - Nationwide and Individual. Nationwide permits are used to authorize minor, non-controversial activities, such as geotechnical drilling, utility line installations, and box culvert construction. Currently, there are 44 types of Nationwide permits. Each of these has activity-specific descriptions and thresholds that must be evaluated and considered during project development, and each has specific conditions under which the Corps of Engineers does or does not need to be notified (permit application). Multiple Nationwide permits can be used on a project. If your project cannot conform to the description of any of the Nationwide permits or if you exceed the threshold of the Nationwide permit applicable to your activity, Individual permits must be used.

The Environmental Planning Group administers the "404 Permit" process within ADOT. Highway designers should contact Environmental Planning Group early in the highway development process and assist them in complying with the applicable requirements of the permitting process.

### **602.3 - Stormwater Regulations for Construction Activities**

Under the provisions of the Water Quality Act of 1987, the Environmental Protection Agency (EPA) has issued regulations which address the issue of stormwater discharges into the waters of the United States.

Highway designers should review the STATEWIDE STORMWATER MANAGEMENT PLAN and identify areas of applicability. Highway designers should contact the Environmental Planning Group early in the highway development process and assist them in complying with the applicable requirements of the permitting process. See [Section 113.1](#) for more information regarding this topic.

### **602.4 - Federal Highway Administration**

Highways, as they connect cities and towns, must cross drainage ways; therefore, encroachment on floodplains is inevitable. Executive Order 11988 and Federal Emergency Management Agency (FEMA) regulations state that floodplain encroachments should be designed in a manner which would minimize development on the floodplain, reduce flood damages, and preserve the natural and beneficial environmental floodplain values. The Federal Highway Administration in 23CFR 650 A enumerates policies and procedures for the location and hydraulic design of encroachments on floodplains.

Application of these federal regulations requires that the magnitude and water surface elevation for the 100-year flood or the overtopping frequency flood, if smaller, be placed on the plans in addition to the design frequency information.

### **602.5 - Local Flood Control Agencies**

Although ADOT may not be required to comply with all regulations and policies promulgated by local flood control districts, all projects should be reviewed for compatibility with local ordinances and practices. This review may identify areas where joint participation is desirable and feasible.

---

## **603 - Storm Frequency and Design Discharge**

### **603.1 - General**

The selection of the design storm is a matter of engineering judgment. When performing drainage design, there is always some risk in any action or non-action taken, even if the design event is the probable maximum flood. Therefore, the use of good engineering judgment, accepted design procedures, evaluation of proposed changes of drainage patterns, and economic assessment of the associated measures is necessary to produce good drainage designs.

Traffic needs; the type, cost, and maintenance of structures; drainage impacts on the highway facility and on the adjacent property; and extent of urbanization should be considered when selecting a design frequency. Flood discharges should consider the changes in land use over the life of the facility. Local zoning maps and regional planning maps can be used as a guide for projected land use. Local drainage requirements and policies need to be considered when evaluating the effect of urbanization. The flow/frequency criteria which control the size of the structure are the design flow/frequency.

Flows of magnitudes greater than the design storm should be considered for evaluating damages to the structure and the roadway, impacts on traffic flow, public and emergency services, and the potential impacts upon upstream and downstream property.

In all cases, it is the designer's responsibility to review the project site conditions with the design frequencies suggested herein and, if warranted, recommend changes in the design frequency.

**Changes in design frequency require approval by the Roadway Engineering Group Drainage Section manager.**

### **603.2 - Design Storm Frequency**

A) *General:* To assist the designer in determining an appropriate design storm frequency for drainage structures on a highway project, the highway routes on the State system have been divided into four classes of relative operational importance. For each class, an operational storm frequency has been established commensurate with an acceptable level of risk of the highway having reduced capacity or damage during a storm.

The **Operational Drainage Frequency Class Map** in Appendix C shows the drainage classes for each route or route segment on the State system. For urban areas, controlled-access freeways not shown on the map are Class 1. For all other roadways not shown on the map, the appropriate class should be determined during the scoping phase considering the long-term goals of the project. The minimum design storm frequencies for the various drainage classes are shown in [Table 603.2A](#).

The design storm frequency may be controlled by other considerations, particularly FEMA regulations.

The designer must carefully evaluate and document the need for designing for higher storm frequencies.

*B) Bridges and culverts:* Bridges and culverts should have the capacity to convey with appropriate freeboard the discharges from storms of the frequencies shown in [Table 603.2A](#). The design storm may be controlled by other considerations.

In addition to capacity design, bridges should be checked for operational and structural adequacy including scour for the design storm and for structural adequacy including scour for the super flood storm. See the ADOT [Bridge Design and Detailing Manual](#) for additional discussion.

**Bridges and culverts at flood channels or detention basins shall conform to the criteria for flood channels or detention basins, respectively, as given in Subsection E below.**

*C) Roadway overtopping:* Roadway profiles should be set to prevent overtopping of the roadway for the storm frequencies given in [Table 603.2A](#).

*D) Pavement drainage:* **For the design storm, the highway pavement drainage system shall be designed to meet the criteria given in [Table 603.2B](#) at the specified storm frequencies.** Pavement drainage systems include inlets, catch basins, storm sewers, main drains, storage reservoirs (detention basins) and pump stations.

**The allowable spread (ponding width) shall meet the criteria given in [Table 603.2C](#) for the 10-year storm event.**

The allowable ponding depth on highways should not exceed the height of the curb for the 10-year storm.

Where local streets are being reconstructed or replaced, the existing drainage systems should be replaced in kind using the local government design criteria except that **in a sump situation, the design storm criteria in [Table 603.2B](#) shall control.**

Depressed roadway criteria apply to any roadway whose ponded depth (ignoring any drainage system) is 30 in. or more.

*E) Ditches, flood channels and detention basins:* **Ditches which intercept cross-flows and redirect them to discharge points shall have the same minimum design storm frequency as for culverts per [Table 603.2A](#).** Ditches which are parallel to the roadway and serve to convey roadway drainage are "cut ditches" or "median ditches" and are covered in [Table 603.2B](#).

**The capacity of flood channels and detention basins shall be designed to meet the requirements of the storm frequency given in [Table 603.2A](#) except where other considerations require a greater storm. Emergency spillways shall be designed to accommodate the peak discharge from the 100-year frequency storm.**

**Table 603.2A**  
**Minimum Design Storm Frequency**

| <b>Highway Level and Condition</b>  | <b>Design Storm Frequency* (yrs)</b> |
|-------------------------------------|--------------------------------------|
| <b>Drainage Class 1</b>             |                                      |
| New construction                    | 50                                   |
| Reconstruction                      | 50                                   |
| Structure affected by major project | 50 <sup>1</sup>                      |
| <b>Drainage Class 2</b>             |                                      |
| New construction                    | 50                                   |
| Reconstruction                      | 50 <sup>2</sup>                      |
| <b>Drainage Class 3</b>             |                                      |
| New construction                    | 25                                   |
| Reconstruction                      | 25                                   |
| Non-drainage projects               | N/A                                  |
| <b>Drainage Class 4</b>             |                                      |
| New construction                    | 10                                   |
| Reconstruction                      | 10                                   |
| Non-drainage projects               | N/A                                  |
| <b>Business Routes</b>              | Use Local Criteria                   |

See [Section 611.3C](#) for allowable headwater elevation at culverts.

See [Section 610.2C](#) for freeboard requirements at bridges.

\* Note: Design storm frequencies may be controlled by other considerations, i.e. FEMA regulations.

1. Exceptions require approval of Roadway Engineering Group Drainage Section Manager.
2. Upgrade only if existing capacity is less than 25 yr. frequency.

N/A: Not applicable

**Table 603.2B**  
**Design Storm Frequency**  
**for Pavement Drainage Systems**

| Roadway Type and Condition                               | Design Storm Frequency (yrs) |
|--|------------------------------|
| <b>Non-Depressed Roadways:</b>                           |                              |
| Storm drain systems:                                     |                              |
| Hydraulic grade line 6 in. below top of grate            | 10                           |
| Cut and median ditches:                                  |                              |
| Hydraulic grade line no higher than subgrade             | 10 <sup>1</sup>              |
| Hydraulic grade line no higher than 3 in. below pavement | **                           |
| <b>Depressed Roadways:</b>                               |                              |
| Storm drain systems:                                     |                              |
| Hydraulic grade line 6 in. below top of grate            | 50                           |

\*\* Use frequency from [Table 603.2A](#).

NOTE: Pavement drainage systems include inlets, catch basins, storm sewers, main drains, storage reservoirs, and pump stations.

1. For divided roadways with median widths ≤ to 50 ft, it may not be practical to achieve criteria.

**Table 603.2C**  
**Allowable Spread**  
**10-year Storm Event**

| Roadway                                      | Spread Criterion                               |
|--|--|
| Two-lane roadway and two-way frontage road   | Shoulder, turn lane, or parking lane.          |
| Multi-lane roadway and one-way frontage road | ½ Lane + shoulder, turn lane, or parking lane. |
| <b>Ramp</b>                                  |  |
| One lane                                     | Un-ponded width of 12 ft.                      |
| Two lane                                     | ½ Lane + shoulder.                             |
| One-lane directional ramp                    | Less than or equal to 8 ft.                    |
| Two-lane directional ramp                    | ½ Lane + shoulder.                             |
| At ramp gores                                | See <a href="#">Figure 603.2A</a>              |
| Auxiliary lanes                              | ½ Auxiliary lane + shoulder.                   |

**NOTE: Refer to roadway cross-section and apply appropriate one or multi-lane roadway criteria. For one-directional crowned roadways, the ½ -lane spread shall be included only on one side.**

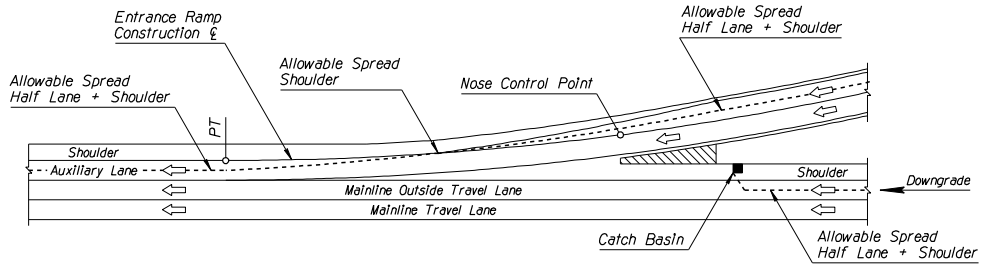

**Urban 1 - Lane Entrance Ramp  
Parallel Type With Auxiliary Lane**

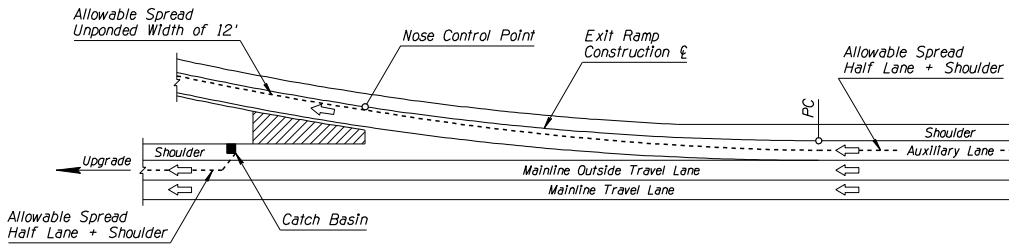

**Urban 1 - Lane Exit Ramp  
Parallel Type With Auxiliary Lane**

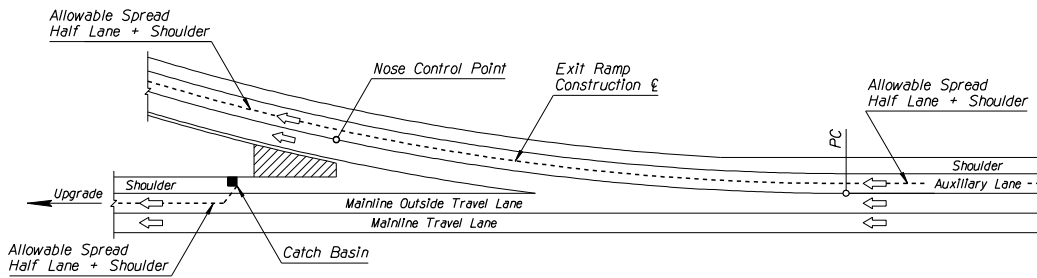

**Urban 2 - Lane Exit Ramp  
Parallel Type With Auxiliary Lane**

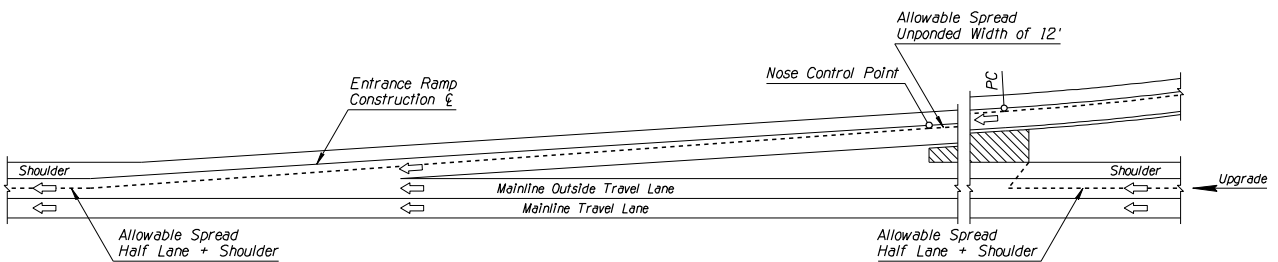

**1 - Lane Entrance Ramp  
Taper Type**

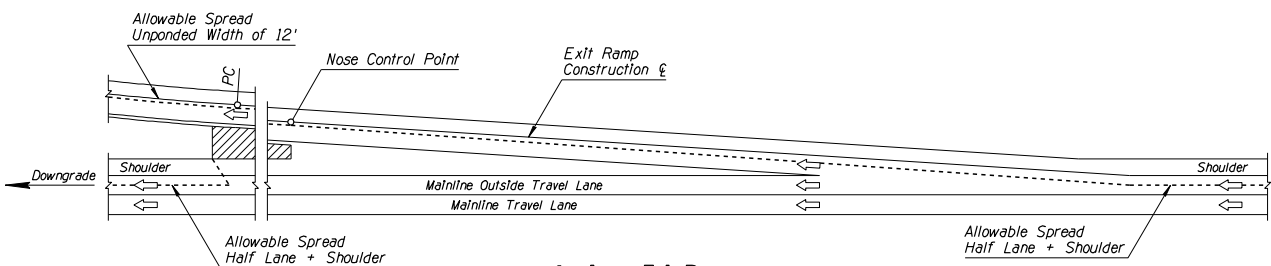

**1 - Lane Exit Ramp  
Taper Type**

**ALLOWABLE SPREAD  
AT RAMP GORES  
FIGURE 603.2A**

## **604 - Hydrology**

### **604.1 - General**

It should be recognized that hydrologic analysis is not an exact science. All hydrologic analysis methods, whether statistical or deterministic, are based upon available data.

Arizona is a large State and comprises several climatological regimes with strikingly different precipitation characteristics. Arizona's few rainfall monitoring stations combined with an uneven distribution of these stations throughout the State has led to a paucity of data regarding rainfall intensities and areal distribution relationships in many areas of the State. The inability to establish strong correlation factors across the State makes it difficult to extrapolate data from one area to another. Therefore, generalized regional tables and charts often present the best available data of rainfall characteristics for hydrological analyses.

For similar reasons, there is a dearth of information correlating rainfall with stream runoff. Several mathematical models have been developed and are accepted by ADOT for use in hydrologic analyses. These models and their use are covered in greater detail in ADOT's Hydrology Manual<sup>1</sup>.

In performing hydrologic analyses and in using their results, the designer must remember that no matter how precise the calculated values, they are only approximations of the probable values. Further, the values are those which, statistically, have a certain probability of being exceeded in a year.

It is the magnitude of the design values which is important, not the precision. Therefore, three significant figures will be sufficient for all hydrologic and hydraulic design values.

### **604.2 - Hydrologic Methods**

Determination of design flow for the selected design frequency should be based upon the following sources, given in order of relative importance:

*A) Existing hydrologic studies:* Where highway facilities encroach upon established or planned Regulatory Floodplains, the flood frequency curve approved by FEMA for the site should be the primary source of data for use in design. In the absence of a FEMA flood frequency curve, runoff rates from drainage studies by other governmental agencies should be evaluated for use in establishing a design flood frequency curve. Such studies must be reviewed for appropriateness with regard to the needs of the facility being designed. There may be instances where two hydrologic values should be used--the FEMA or other agency value to evaluate the impacts of the ADOT system upon the existing FEMA floodplain/floodway and an ADOT value to size the drainage facilities.

*B) Gaging station records:* Available stream runoff records may be analyzed in accordance with methods described in the ADOT Hydrology Manual to determine an appropriate design flow.

C) *Rainfall-runoff models*: Rainfall-runoff models should be used where stream runoff data are not available. For drainage areas of 160 acres or less, the Rational Method may be used. For drainage areas greater than 160 acres the US Army Corps of Engineers computer program HEC-1 should be used.

Approved procedures and recommended parameter values for the Rational Method and HEC-1 are presented in the ADOT Hydrology Manual<sup>1</sup>.

## **605 - Documentation**

### **605.1 - Reports**

All drainage designs should be documented with a drainage report which presents the data and assumptions which underlay the design solutions. In general, the report should contain conclusions and recommendations, as appropriate, as well as all pertinent data, maps and information, calculations and analyses, hydrologic and hydraulic data, including economic comparisons of alternates. For additional guidance see Chapter 6 of the ADOT Hydraulics Manual<sup>2</sup>.

### **605.2 - Field Investigations**

Field investigations should be performed at all stream crossings and drainage ways to document existing conditions at the site of a proposed drainage structure. The procedures for obtaining field survey data are presented in the ADOT Location Manual<sup>3</sup>. In general, field investigations should consider:

- The hydraulic characteristics of the proposed crossing, including past and potential future problems at and adjacent to the crossing;
- The hydraulic performance of existing structures on the waterway; and,
- Other pertinent features which affect the hydraulic design of potential structures at the site.

### **605.3 –Drainage Easements**

Easements may be necessary to mitigate the impacts of drainage facilities on adjacent property. Documentation of the factors which necessitate a drainage easement will assist the Right-of-Way Group in negotiating and obtaining the required easement. The absence of a drainage easement may preclude the use of a desirable drainage design solution. Early coordination with Right-of-Way Group is encouraged to permit timely acquisition of easements.

Several factors must be considered when evaluating the necessity of acquiring an easement, including the area of flooding, depth of flooding, extent of existing development, extent of

future development, land ownership, and cost of easement versus fee title. Maintenance access should also be considered in identifying the need and size of drainage easements.

An area to be subject to ponding must be evaluated for determination of existing conditions and the effects of the proposed project, both upstream and downstream. Ponding is useful to maximize the hydraulic performance of culverts; however, the ponding should be controlled to reasonable limits and the possible higher outlet velocities should be evaluated for impacts downstream.

## **606 - Roadway Drainage**

### **606.1 - Design Methodology**

The design discharge for pavement and median drainage systems should be calculated using the Rational Method. The design of elements which are used to collect and remove storm water from highway pavement surfaces and median areas should be performed in accordance with Chapter 12 Pavement Drainage, ADOT Hydraulics Manual<sup>2</sup>.

The design of the storm drain conveyance system should be in accordance with [Section 607](#) of this manual. The allowable spread of water on a roadway for various conditions is given in [Section 603.2](#).

Side-street runoff and off-site drainage should be intercepted before reaching the highway pavement. Curbed roadway sections and pavement drainage inlets are inefficient means for handling off-site drainage.

Cut slope drainage is normally intercepted in cut ditches. For depressed sections in the Urban Freeway System, the on-site cut slope drainage is captured in the gutter section. If the roadway cross-slope is to the opposite side, a cut ditch is used. Cut slope drainage should not be allowed to flow across the travel lanes.

All off-site drainage that is included in the design of a storm drain system should be captured in a sump situation outside the pavement area or within the pavement cross section of the approach street.

### **606.2 - Inlets**

*A) Capture ratio:* **To account for a potential reduction of inflow capacity due to clogging, the design length, perimeter or area, as appropriate, of inlets shall be calculated using the capture ratios shown in [Table 606.2](#).** Capture ratio is the ratio of the unclogged opening to the total opening.

The pipe connecting the inlet with the storm drain should be designed for the maximum flow capacity of the unreduced inlet opening. Generally, the maximum flow capacity of the inlet will be 1.2 times the design flow for inlets on grade and 2.0 times design flow for sump inlets. Where grate inlets are provided in combination with slotted inlets or curb inlets the combined openings should be used to determine the maximum inflow.

**Table 606.2  
Inlet Capture Ratios**

| Inlet Type                        | Capture Ratio |
|-----------------------------------|---------------|
| <b>Grate Inlets</b>               |               |
| On grade                          | 0.50          |
| Sump                              | 0.50          |
| <b>Curb Inlets</b>                |               |
| On grade                          | 0.80          |
| Sump                              | 0.80          |
| <b>Combined Curb and Grate</b>    |               |
| On grade                          |               |
| Curb inlet                        | 0.80          |
| Grate inlet                       | 0.50          |
| Sump                              |               |
| Curb inlet                        | 0.80          |
| Grate inlet                       | 0.50          |
| <b>Combined Slotted and Grate</b> |               |
| On grade                          |               |
| Slotted inlet                     | 0.67          |
| Grate inlet                       | 0.50          |
| Sump                              |               |
| Slotted inlet                     | 0.50          |
| Grate inlet                       | 0.50          |

*B) Restrictions on inlet types: All grates shall be bicycle safe on facilities where bicycles are allowed (see ADOT Bicycle Policy).* Construction Standard Drawing C-15.50 grates are preferred. See [Figures 606.2A](#) and [606.2B](#) for bicycle safe inlet requirements for freeway ramp termini at cross streets and frontage roads.

**Curb opening inlets (Construction Standard Drawing C-15.10, C-15.20 and C-15.40) shall not be used in pump station collection systems.**

Standard Inlet C-15.10 should be used only in sump conditions when not part of a pump station system.

Standard inlets C-15.10 through C-15.40, C-15.91 and C-15.92 are for on-roadway use only. Standard inlets C-15.80, C-15.81 and C-15.90 are for off-roadway use only. All off-roadway inlets within the roadway recovery area should be designed with 3-in. or less local depression.

**606.3 - Median Drainage**

Median dikes should be provided downstream of median inlets or culverts except where the inlet is located in a sag. The elevation of the median dike should be at least 1 ft lower than the adjacent edge of traveled way.

Where flow velocity is erosive, erosion control measures should be provided.

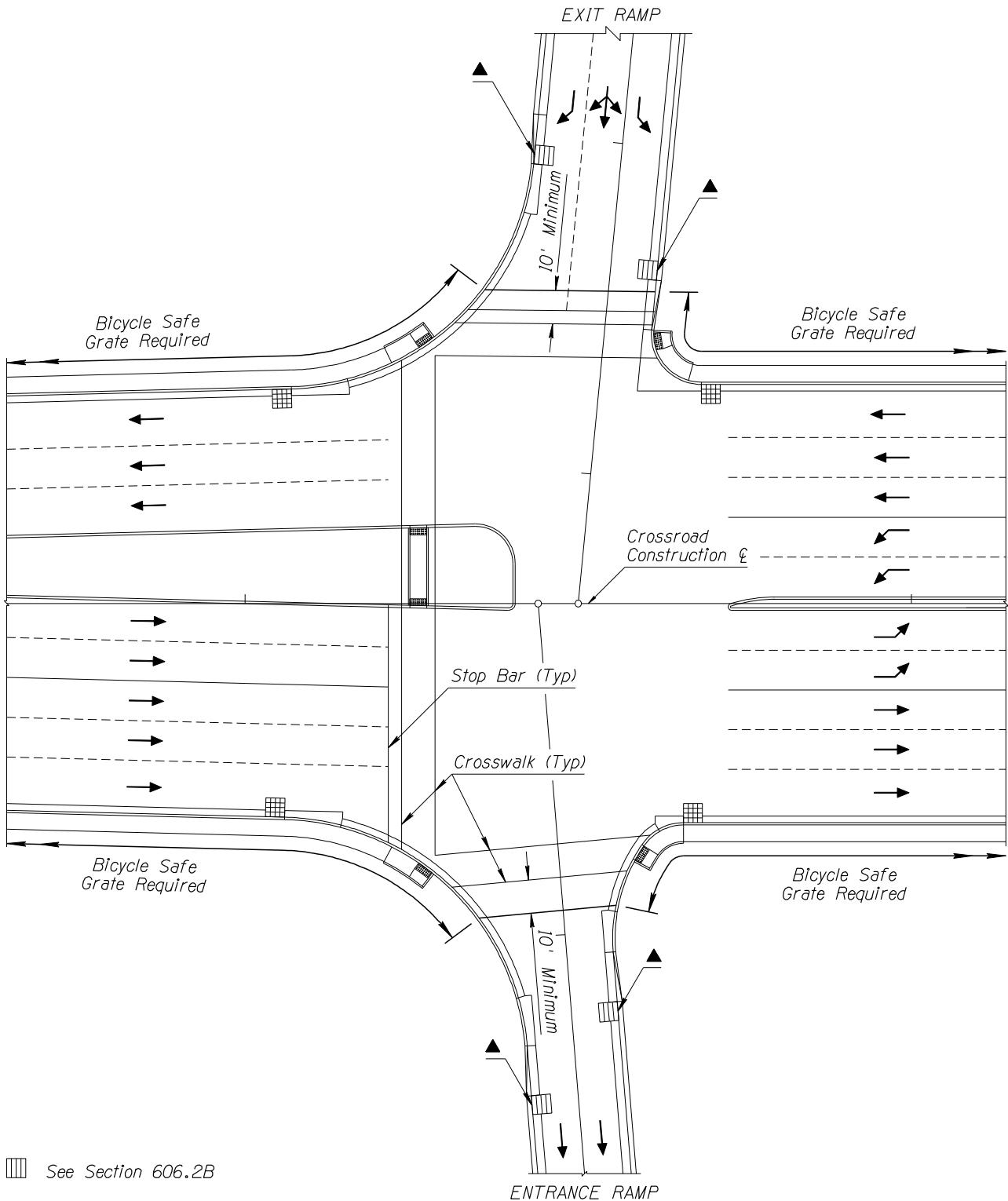

▨ See Section 606.2B

▣ Bicycle safe grates are required at catch basins along the crossroad and within 10' of the crosswalk at the freeway ramp termini

▲ Bicycle safe grates are required on ramp where bicycles are allowed

**BICYCLE SAFE GRATES  
AT RAMPS / CROSSROAD  
FIGURE 606.2A**

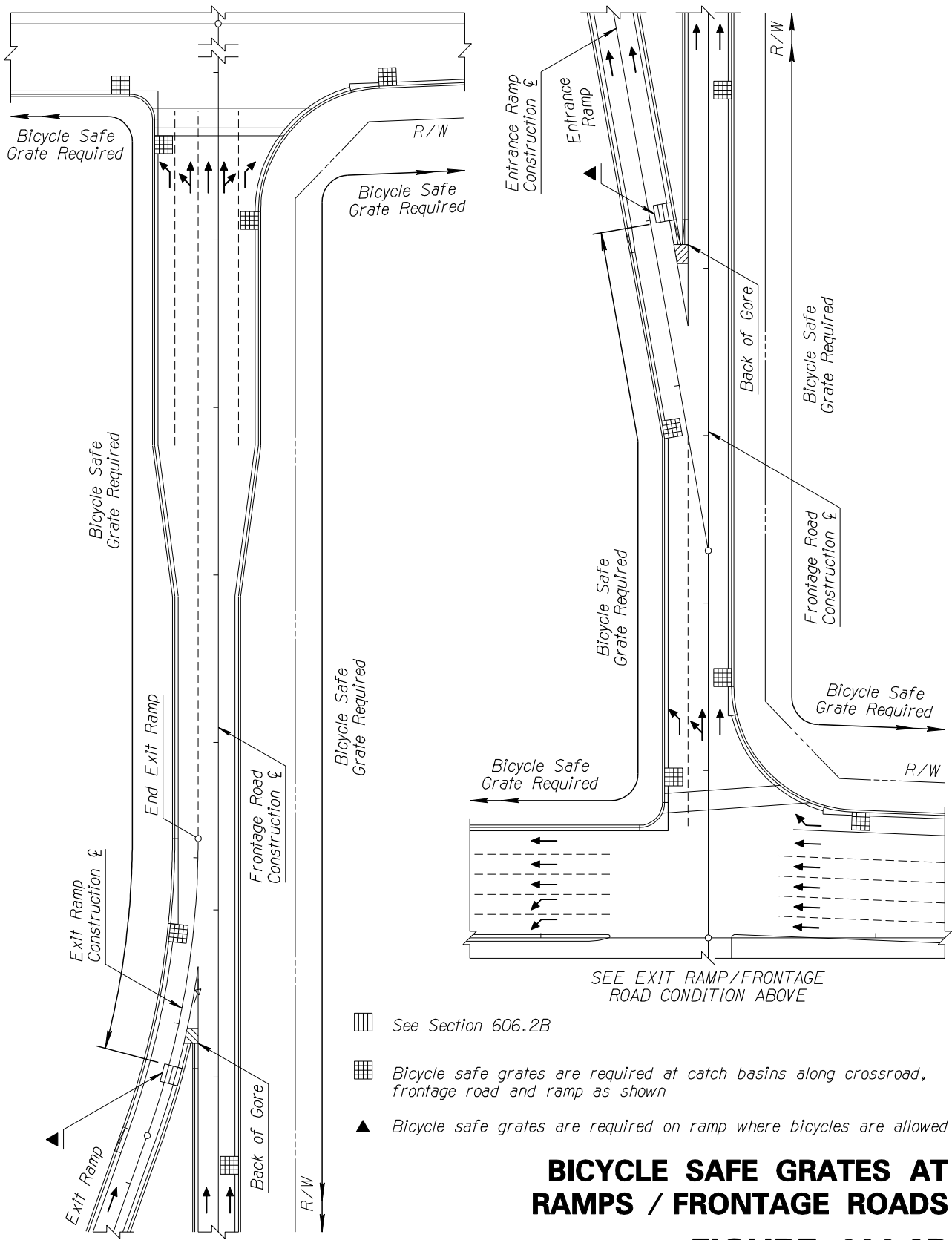

**BICYCLE SAFE GRATES AT RAMPS / FRONTAGE ROADS**  
**FIGURE 606.2B**

## 606.4 - Bridge Decks

The design discharge for bridge deck drains should be calculated using the Rational Method. Deck drains should be spaced to satisfy the design spread criteria given in [Section 603.2](#).

Bridges which do not connect with a curb-and-gutter roadway section should have drains installed at the downstream ends. The drains should be sized to preclude the bypass of concentrated flows which can erode the roadway embankment.

Sidewalks on bridges are often at a lower grade than the sidewalks along the approach roadways. In designing the transition between the roadway and bridge sidewalks, special attention should be given to capturing the concentrated flows which can erode the roadway embankment and to avoiding or mitigating pockets which capture drainage.

## 607 - Storm Drains

### 607.1 - Design Considerations

Storm drains are the conveyance system for flows from roadways and adjacent contributory areas to a convenient outlet. **The pipe material, construction methods and the resultant pipe roughness coefficients shall be considered in the preliminary design of the storm drain.** The hydraulic grade line, including all junction losses, should be computed for all storm drains and compared with the requirements in [Table 603.2B](#).

**Pipe size selection for storm drains shall be based on the design flood (See Table 603.2B) for full-flow conditions.**

The minimum pipe size for a storm drain system should be 24 in. except that pipes connecting inlets to a trunk line should be 18 inch. Eighteen-in. pipe may be used where conflicts with utilities or other highway appurtenance features preclude the use of a 24-in. pipe. **Pipes less than 18 in. shall not be used.**

The minimum velocity for a storm drain is 2 ft/sec assumed flowing full with a desired minimum "self-cleaning" velocity of 3 ft/sec.

### 607.2 – Manholes (Construction Standard Drawing C-18.10)

Manholes should be placed at all changes in grade or alignment and at intermediate points to not exceed the desirable maximum spacing shown in [Table 607.2](#). The spacing of manholes should be coordinated with the location of lateral connections to the trunk line. (See [Section 607.4](#).) Where there are significant variations in the ground profile over a trunk line, the maximum desirable manhole spacing may be increased to permit locating manholes to minimize the manhole heights.

**Table 607.2**  
**Maximum Manhole Spacing**

| <b>Pipe Size</b>  | <b>Desirable Maximum Manhole Spacing (ft)</b> |
|-------------------|---|
| Under 33 in.      | 330   |
| 33 in. to 39 in.  | 440   |
| 42 in. to 69 in.  | 660   |
| 72 in. or greater | 1200  |

Manhole covers are to be identified as shown on the Construction Standard Drawing.

### 607.3 - Lateral Connections

Lateral connections may be made by use of collars, Y's, T's or manholes. Economic comparisons should be made to determine the desired combination and configuration of lateral pipe runs and connection type. Generally, only two or three lateral pipes should enter an individual manhole.

### 607.4 - Pipe Roughness

Manning's "n" values, given in Table 607.4, are for those installations which satisfy the requirements of Section 607.5.

**Table 607.4**  
**Manning's "n"**

| <b>Pipe Type</b>             | <b>"n"</b> |
|------------------------------|------------|
| Concrete Pipe:               | 0.012      |
| Cast-in-Place Concrete       | 0.014      |
| Smooth Plastic: Polyethylene | 0.012      |
| Spiral Rib: Galvanized Steel | 0.014      |

### 607.5 - Guidelines for use of Pipe Materials

**The types of pipe materials which are acceptable for the particular site conditions shall be as determined by the Pipe Selection Guidelines and Procedures.<sup>4</sup>**

The ADOT Materials Group is responsible for determining the site conditions which impact a pipe's service life. The roadway designer should contact ADOT Materials Group early in the design process to coordinate the locations of all potential culvert locations to avoid delays in obtaining soil test results.

## **608 - Channels and Ditches**

### **608.1 - Channels**

Channels are conveyances for storm drainage which have a vertical alignment independent from the highway. Channel construction quantities are not normally included in the roadway template. The horizontal and vertical alignment of a channel must be defined on the plans.

Channels should be designed to maintain existing flow regimes. Changes in the alignment of natural channels should be as gradual as terrain and right-of-way permit. Where possible, alignment changes should be in those reaches that have the flatter slopes. Alignment changes should be reviewed for potential erosion.

Drainage channels parallel to the roadway should be located outside the recovery area. When this cannot be accomplished, channel slopes and bottom widths located within the recovery area should meet the preferred channel cross-section guidelines recommended in the AASHTO "Roadside Design Guide". The use of longitudinal barrier should be considered where the above conditions cannot be provided.

In addition to the above requirement:

- A. Side slopes on main channels should be designed for the soil conditions at the site. Side slopes of aggregate lined and unlined channels should not be steeper than 3:1 (H:V). Concrete lined channels (see [Section 608.6](#)) should have side slopes desirably no steeper than 2:1 with an absolute maximum slope of 1.5:1. **If steeper slopes are required, the lining shall be designed as a retaining wall for appropriate lateral earth pressures.** Subgrade treatment should be on a site-specific basis as recommended by ADOT Materials Group.
- B. Channel bottoms should have a desirable width of at least 8 ft for maintenance purposes and a minimum width of 4 ft. Channel bottoms should have a 2% cross-slope to one side to provide for concentration of low flows and transportation of sediment. The channel profile should be at the low edge.

### **608.2 - Hydraulic Design of Open Channels**

The maximum grade of unpaved channels should be based upon the tolerable velocity for vegetation and soil type. The minimum grade for channels should be based on obtaining velocities to avoid sedimentation. Desirable minimum grades are 0.20 % for earth or grass-lined channels. The desirable minimum grade for smooth paved channels is 0.10%.

The maximum grade of paved channels should be based upon the requirements of the project; the upstream and downstream conditions; operation and maintenance considerations; good engineering judgment; and economics. Generally, maximum velocities should not exceed 30

ft/s. Greater velocities may be warranted; **however, the impacts of the flowing water on the channel lining shall be evaluated.**

Water surface profiles may be computed using the Standard Step Method. Steady flow in uniform channels should be computed using Manning's Formula. Manning's roughness coefficient should be selected considering the channel material and textural properties in accordance with accepted published values. A minimum Manning's "n" applicable to the channel should be used for checking sections for scour and velocity. The maximum Manning's "n" applicable to the channel should be used for water depth and required cross-section determination. **Where the channel is adjacent to a highway, the channel depth of flow shall be limited so as to preclude saturation of the roadway pavement structural section at a 10-year frequency storm.** For the minimum design storm frequencies see [Table 603.2A](#)

### 608.3 - Channel Transitions

Energy losses, wave disturbances, and velocity changes must be considered at channel transitions. The analysis and design of transitions should be performed using methods which incorporate energy and momentum principles.

Vertical wall type transitions as shown in [Figure 608.3](#), are desirable. This type of transition simplifies construction, resists earth pressure and eliminates potential compressive problems in a warped slab. While this type of transition does not have hydraulic properties as good as the warped method, the above characteristics make the vertical wall transition preferable.

Table 608.3 presents allowable transition rates at channel contraction or expansion sections. With the transition rates shown in Table 608.3, contraction and expansion head loss coefficients of 0.2 and 0.4, respectively, should be used for the vertical wall transition.

**Table 608.3**  
**Channel Expansion and Contraction**  
**Transition Rates**

| Velocity (fps) | Transition Rates <sup>1</sup>     |
|----------------|-----------------------------------|
| Less than 10   | Simplified transition or headwall |
| 10 to 15       | 1:10                              |
| 15 to 30       | 1:15                              |

NOTE: 1 The degree of convergence or divergence at either bottom or top edge of transition walls, expressed as the ratio of lateral to longitudinal distance.

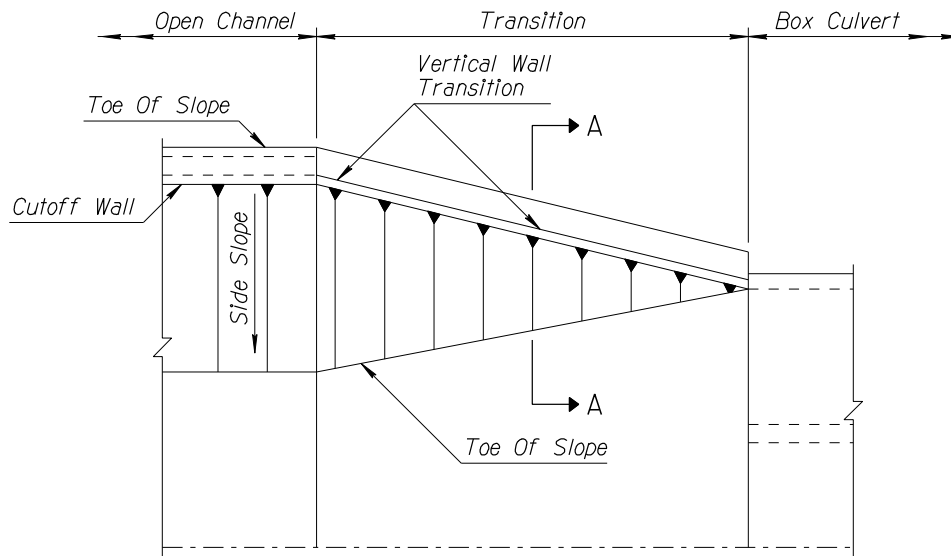

**PLAN**

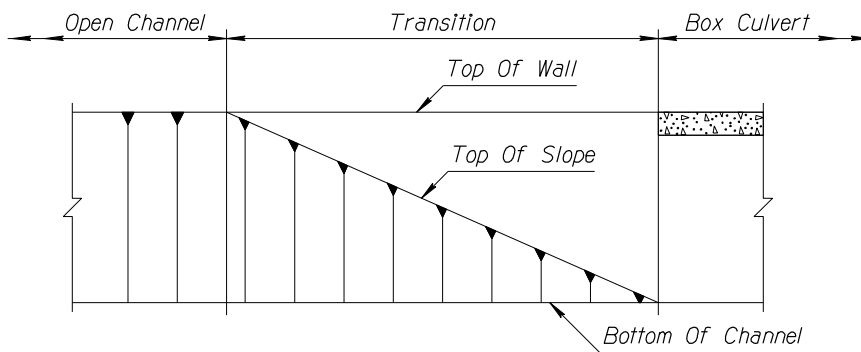

**ELEVATION**

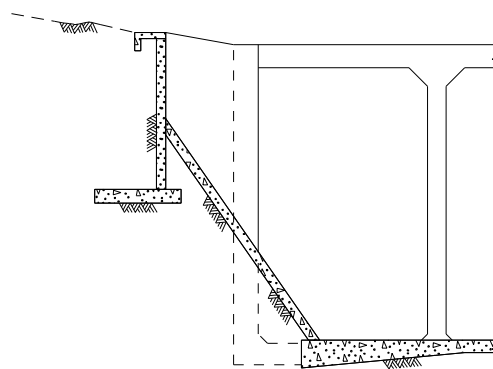

**SECTION A-A**

**OPEN CHANNEL VERTICAL  
WALL TRANSITION  
FIGURE 608.3**

### 608.4 - Freeboard

In selecting the design freeboard for an open channel, consideration should be given to the channel's size and location, the inflow characteristics, expected water surface fluctuations, the general soil conditions, the expected amount of debris, and the consequences of overtopping.

**Where overtopping would permit storm water to break out of ADOT right-of-way, the minimum freeboard shall be 1 ft.**

For channels with flows having Froude Numbers equal to or greater than 0.86, the minimum freeboard should be the larger of 1 ft or the value

$$F = 0.20 \left( y + \frac{v^2}{2g} \right)$$

where:

- F = desired freeboard (1 ft minimum), ft;
- y = depth of flow, ft;
- v = mean velocity, ft/s;
- g = acceleration due to gravity, 32.2 ft/sec<sup>2</sup>.

For leveed channels where the water surface elevation is higher than natural ground, provide an additional 1-ft of freeboard to accommodate surface irregularities and alignment adjustments.

### 608.5 - Superelevation

**Additional height shall be provided on the outside of a channel bend equal to the additional rise in the water surface between the channel centerline and the outside wall.** Superelevation should be calculated using the following formula:

$$Y = \frac{Cv^2W}{gr_c}$$

where:

- y = superelevation at outside of curve, ft;
- v = velocity, ft/s;
- W = channel width at water surface, ft;
- r<sub>c</sub> = radius of curvature at channel centerline, ft (a ratio of r<sub>c</sub> / W ≥ 3 is desired);
- g = gravity coefficient, 32.2 ft/sec<sup>2</sup> and,
- C = coefficient; 0.5 for subcritical flow and 1.0 for supercritical flow in rectangular and trapezoidal sections.

### 608.6 - Channel Lining

Linings may be either rigid or flexible. **All linings shall be designed to minimize their susceptibility to scour at their edges and terminals.** The channel lining thickness and reinforcement should be designed for the soil conditions at the project site and should consider any negative pressures which might occur, and any collapsing or expansive soils.

Pressure relief of channel linings should be provided by geotextile or geocomposite drainage strips and 4-in. diameter PVC weepholes. Openings should be located 12 in. vertically above the channel bottom. Weepholes should slope 3 in. from back to face of lining. The spacing of weepholes should be based on subsurface investigations, potential future changes in ground water levels, any structural backfill, and any parallel or crossing utilities.

The hydraulic designer should consult with the Materials Group regarding lining thicknesses, side slopes, weephole requirements, and any required subgrade treatment.

### 608.7 - Cutoff Walls

Cutoff walls will be required:

- where new lining abuts an existing concrete or other type of lining which is not continuously reinforced; (a sealed expansion joint should be provided between the new and existing linings);
- at the beginning (upstream end) of a transition section to widen the channel;
- at breaks in the channel profile of more than 0.9 %; and
- at existing structures where the new lining cannot realistically be made continuous with the existing lining.

### 608.8 - Drainage Outlets into Major Watercourses

The drainage area of a flood channel is, generally, much smaller than that of the main watercourse into which the flood channel discharges. Peak times of floods at the junction of two different sources normally would be quite different. The peak of the flood channel may arrive at the junction when the water level of the main watercourse is still low.

The outlet should be designed to the design peak flow of the channel concurrent with the 10-year peak flow in the main watercourse. It should also be designed for the 10-year peak flow in the channel concurrent with the design peak flow in the main watercourse. For bank protection measures at the outlet and nearby channel, water levels of the design peak flow in either the main watercourse or flood channel (not concurrent peaks) should be considered.

### 608.9 – Channel Inflows

**Channel inflows shall be accommodated in a manner that does not incur erosion of the sides or bottom of the channel.**

### 608.10 - Energy Dissipators

An energy dissipator may be required to reduce the energy of flowing water at an outlet. Wire-tied energy dissipators should be designed in accordance with Chapter 9 of the ADOT Hydraulics Manual<sup>2</sup>. Drop structure, chute spillway, and stilling basin energy dissipators should be designed in accordance with the procedures in the FHWA HEC No. 14 Hydraulic Design of Energy Dissipators for Culverts and Channels<sup>9</sup>.

### 608.11 - Maintenance

A 20 ft wide strip, gently sloping towards the channel, is desirable on both sides of drainage channels for maintenance access. **As a minimum, a 12 ft wide strip shall be provided.** Maintenance access may be provided solely on one side with the concurrence of the District. **Right-of-way limitations which prevent meeting at least the minimum requirement shall be brought to the attention of the Assistant State Engineer, Roadway Engineering Group.**

Ten-ft wide maintenance access ramps should be incorporated into the channel design to provide access into the channel upstream and downstream of hydraulic structures. The access ramps should be no closer than 100 ft from the nearest channel transition and should be located on the high side of the channel invert. Whenever possible, the ramps should slope downward in the downstream direction.

### 608.12 - Ditches

Ditches may be required for on-site drainage or small local off-site drainage. Usually, design discharges are less than 100 cfs. The design storm frequencies for ditches are shown in [Table 603.2B](#). If the ditch drains to a drainage structure designed to a higher frequency storm, the higher frequency storm should also be considered in the ditch design at the discharge location of the ditch. At the discharge location, ditches should be sized for the structure design storm capacity at the bank-full depth instead of adding freeboard to the water depth of the 10-year storm. The backwater due to the ponding at culverts and other structures must be considered in the water depth computations.

Ditches whose failure would endanger life or property require freeboard as discussed in [Section 608.4](#).

## 609 - Detention Basins

### 609.1 - General

Detention basins may be provided for attenuation of peak discharges by storing run-off from on-site or off-site drainage. See Section 603.2E for design criteria. **Outflow discharges from the basin shall not cause peak discharges downstream greater than peak discharges**

without the project unless approved by the Roadway Engineering Group Drainage Section Manager.

**No basin shall be designed to retain standing water longer than 36 hours after the 24-hour design storm has passed without the approval of the Roadway Drainage Section Manager.**

### 609.2 - Layout

Detention facilities should be designed with a 20 ft wide setback from each property line or roadway section. Side slopes should not be steeper than 3:1 (H:V). **The maximum depth of the basin shall not exceed 25 ft. The maximum design water level of the basin in normal operation shall not exceed the level of the natural ground unless approved by the Roadway Engineering Group Drainage Section Manager.** The need for fencing around the site should be evaluated.

**Dams shall not be constructed as a part of the highway facilities.**

Outlet structures must be placed to insure complete basin drainage. Low-flow channels or underdrains are required on the bottom of the basin leading from inlet to outlet. Free flow capacity of the outlet pipe should be used for low-flow channel design. **Dry wells shall not be used as the primary means of dewatering the basins without the approval of the Roadway Engineering Group Drainage Section Manager. If used, they shall be registered with ADEQ.**

Where flow enters the basin, protection of side slopes and bottom will be necessary. Energy dissipating structures may also be needed. Minimizing future maintenance and operational costs are important elements for design consideration. Erosion control and ease of removal of silt and debris must also be considered in the design of the facility.

### 609.3 - Detention Basin Routing

Detention basin design should be based upon an inflow hydrograph. The required detention storage should be determined through the basin routing by using the inflow hydrograph and outflow-rating curve.

### 609.4 - Emergency Spillways

**Every detention facility shall have an emergency spillway which is designed to allow overflow of run-off when the outlet is blocked and the storage is exhausted.** A broad-crested weir is normally used for overflow purposes because it is not easily blocked.

Discharge from emergency spillways should flow where, historically, the flows have gone. If the flow has to be diverted to the neighboring drainage area, the designer should consider a watercourse or measures which can minimize flood damage.

## **610 - Bridges**

### **610.1 - Hydraulic Design**

*A) Waterway Opening:* The bridge waterway opening should be designed to meet the design storm frequency criteria of [Section 603.2](#). The waterway opening should be sized and situated such that:

- Backwater is limited as described in subsection B;
- Erosion of banks is limited;
- Progressive sedimentation is not encouraged;
- General and local scour are minimized; and
- Minimal bank protective works are needed.

All structures cannot economically be designed to pass all possible flows without backwater effects; therefore, the effects of flows greater than the design flow must be assessed. Relief flow over the roadway may be used to control backwater levels for flows greater than the design flow.

*B) Allowable backwater:* **All backwater increases which extend onto adjacent property shall be reviewed for determination of easement requirements. (See [Section 605.3](#) for additional discussion of easements.)** The backwater created by a bridge and the roadway embankment at the design flood condition should not increase flooding of farmland, developable lands or buildings. (Developable land is land on which there is a high probability that buildings will be constructed within 20 years of design of the crossing.)

**Backwater computations for a bridge shall be based upon approved methodology and on the design conditions which result in the highest value of backwater. The backwater shall be computed with no allowance for scour, i.e. with rigid channel boundaries.**

**Enlargement of the natural channel cross-section at a bridge as a means of reducing backwater shall not be of a nature that will cause erosion of the stream banks, and the enlargement shall not be susceptible to being rendered ineffective by progressive sedimentation or growth of vegetation.**

### **610.2 - Structure Considerations**

*A) Location and alignment:* The bridge piers and abutments should be located to:

- Minimize hindrance to the passage of water and debris;
- Be compatible with the location of piers and abutments of adjacent structures;
- Minimize the depth of local scour; and
- Minimize upstream and downstream bank erosion.

*B) Piers:* Structural elements exposed to flowing water should be round or have the upstream end rounded. Solid wall piers should only be used where the direction of flow is well controlled and will remain so in the future. The piers should not be used to align the flow.

C) *Freeboard*: For flows at the roadway design frequency as given in [Table 603.2A](#), clearance should be provided between the lowest point of the superstructure and the design water surface sufficient to prevent damage to the structure by the action of flowing water and floating debris. Freeboard should be not less than 3 ft for bridges on Class 1 routes (Appendix C) and 1 ft for bridges on routes of Classes 2 to 4 but not less than the design freeboard of the approach channel.

For structures with haunched superstructure soffits, the minimum freeboard should be provided at the low point of each span except that the minimum freeboard on Class 1 route bridges needs to be provided only at the center 0.9 of the span. Freeboard at the ends of the span should be at least 1 ft.

D) *Buoyancy and lateral displacement*: Structures which could be submerged for flows larger than the design flow should be designed for buoyant forces and stream lateral forces. Means should be provided to prevent movement of the superstructure due to buoyant or lateral forces. Air vents near the tops of girders or other structural components to permit the escape of entrapped air should be considered. Bridges which are designed for submerged conditions must be approved by the **Assistant State Engineer – Bridge Group**.

E) Hydraulic calculations: Transitions and friction head losses as well as pier head losses should be considered. **The USACE HEC-RAS program shall be used to analyze the hydraulic conditions at bridges**

F) *Scour*: The total scour at a highway crossing comprises:

- Aggradation and degradation which are long term stream bed elevation changes due to natural or man-induced causes (e.g. gravel mining) within a reach of the river;
- General scour and contraction scour which involve the removal of material from the bed and banks across all or most of the width of a channel resulting from a contraction of the flow, a change in downstream control of the water surface elevation, or the location of the bridge in relation to a bend; and,
- Local scour that occurs around piers, abutments, spurs and embankments caused by the acceleration of the flow and development of vortex systems induced by the obstructions to the flow.

Hydraulic studies should include estimates of the total scour at bridge piers and abutments. The effective pier width for calculation of local scour should consider debris and local skew angle of flow. **A minimum skew angle of 15 degrees shall be used in computations.**

**Bridge foundations shall be designed to withstand the effects of scour without failing for the worst conditions resulting from floods equal to or less than the design flood while the bridge remains fully functional and open to traffic. Bridge foundations shall be checked to ensure that they will not fail due to scour resulting from the occurrence of floods in magnitude between the design event and a superflood on the order of a 500-year flood.**

The geotechnical analysis of bridge foundations should be performed on the basis that all stream bed material in the scour prism above the total scour line of the flood being considered has been removed and is not available for bearing or lateral support.

Additional information on scour may be found in HEC No. 18, Scour at Bridges<sup>7</sup>. Scour analysis procedures should follow those presented in the ADOT Hydraulics Manual<sup>2</sup>.

## **611 - Culverts**

### **611.1 - General**

This section is for closed invert culverts, i.e., those composed of structural material around the entire perimeter. **Structures which have earthen inverts (e.g. arch culverts) shall be designed in accordance with Section 610.**

### **611.2 - Material**

**The types of pipe materials which are acceptable for the particular site conditions shall be as determined by the Pipe Selection Guidelines and Procedures.<sup>4</sup>**

ADOT Materials Group is responsible for determining the site conditions that impact a pipe's service life. The roadway designer should contact ADOT Materials Group early in the design process to coordinate the locations of all potential culvert locations to avoid delays in obtaining soil test results.

### **611.3 – Design Considerations**

*A) Waterway opening:* Pipe culverts used for drainage should normally have a minimum diameter of 24 inches. A minimum diameter of 18 in. may be considered in rare cases where there is minimal available cover.

**Box culverts shall have an absolute minimum height of 4 ft, a desirable minimum height of 6 ft, and a minimum width of 6 ft.**

*B) Hydraulic calculations:* Culverts should be designed for the minimum design storm frequencies shown in [Table 603.2A](#) except where a greater storm is required by other considerations.

**The hydraulic design of closed invert culverts shall be performed using the procedures in FHWA HDS No. 5, Hydraulic Design of Highway Culverts<sup>6</sup>.** Headwater and tailwater elevations and created heads (height between headwater elevation and tailwater elevation) should be shown in the calculations for the design flood.

Since the velocity head in the entrance pool is usually small under ponded conditions, water surface or headwater pool elevations are assumed to equal the elevation of the energy grade line in HDS No. 5. Tailwater level is the elevation of hydraulic grade line at the outlet.

If the upstream reach is channelized, the velocity heads should be taken into account by performing water surface calculations. Head losses include entrance losses, friction losses and any pier losses.

*C) Headwater:* For the design flood, the headwater level should be no higher than 3 in. below the pavement. Generally, the headwater depth to culvert height ratio should not exceed 1.5.

With the 100-year flood, water levels should not significantly increase the flood damage potential on areas outside of ADOT right-of-way. The backwater created by a culvert at the design flood condition should not increase flooding of farm land, developable lands or buildings. (Developable land is that on which there is a high probability that buildings will be constructed within 20 years of design of the crossing.) **All backwater increases above existing conditions which extend onto adjacent properties shall be reviewed for determination of easement requirements. (See [Section 605.3](#).) If flood routing is used for hydraulic design of a culvert, the design shall be reviewed for determination of easement acquisition to prevent "filling-in" of the storage area.**

*D) Sediment and debris accumulation:* In areas where there is a strong probability of sediment and/or debris accumulation at the culvert, the culvert design should encourage self-cleaning. Upstream grade-control structures, siltation basins, channels, and debris control structures should be considered. Where sediment deposition is an issue, a larger structure should be considered.

*E) Culvert embedment:* **Whenever the invert of the culvert is embedded below the natural streambed thalweg, the designer shall investigate the flow capacity of the culvert. No embedded area shall be included in the effective culvert waterway opening where the embedded area is back-filled with erosion resistant material or where siltation to the original grade can be anticipated.**

*F) Cover:* Pipe culverts should have at least 1 ft of embedment below the pavement structural section. In no case should culverts have less than 1 ft of cover within the pavement width (edge to edge) without special protective measures.

In special cases box culverts may encroach into the pavement structural section. In such cases, consideration should be given to providing approach slabs or other mitigating measures.

*G) End treatment:* End sections or headwalls should be provided on all culverts.

Where the capacity of a culvert is controlled by inlet conditions, consideration should be given to providing an improved inlet to enhance the culvert performance.

**Culverts with a span or diameter greater than or equal to 48 in. shall have concrete headwalls.**

Concrete box culverts should have inlet cut-off walls. Concrete box culverts should have an appropriately designed 4-ft minimum depth outlet cut-off wall.

Culverts with a span or diameter 48 in. or greater should have an apron with cut-off wall where the outlet velocity and downstream bed material are such that significant scour is likely to occur.

When used, concrete cut-off walls, headwalls and partial headwalls should extend at least 2 ft below the ultimate bed elevation and a minimum of 4 ft below culvert inverts.

**When used, cut-off walls, headwalls, partial headwalls and aprons shall be securely attached to the culvert.**

An evaluation of the outlet scour potential should be made at all culverts. Riprap at the outlet should be considered whenever the outlet velocity is between 4 and 15 ft-per-second (fps). When the outlet velocity is greater than 15 fps, energy dissipators should be considered. (See [Section 612.2C](#)).

See Construction Standard Drawing C-13.10 for required plating at pipe end sections.

*H) Culvert Alignment:* Culverts should be located so as to fit the natural drainage in line and grade whenever practical. Where required, changes of horizontal alignment should be accomplished by means of gradual curves or by angular changes of direction not exceeding 15 degrees at intervals of not less than 50 ft. Locations where this is not feasible should be discussed with the Roadway Drainage Section.

*I) Extension of existing culverts:* Extension of existing culverts should be designed to minimize the possibility of blockages resulting from changes of direction, cross-sectional shape or number of openings. Extensions should be evaluated for effects on hydraulic capacity of the culvert. Angle changes greater than 25 degrees should be discussed with the Roadway Drainage Section.

*J) Storm sewer and channel outlets:* Outlets of storm sewers and open channels discharging into or adjacent to culverts or bridges should be designed to prevent harmful erosion or damage to the structure. Where possible, storm drain outlets should be located on the downstream side of the roadway, through the outlet wingwalls. The use of an outlet apron should be considered.

*K) Dual purpose structures:* **Structures for both drainage and stock/vehicle/equestrian passage, shall be limited to special cases where economics dictate combined usage.** They should be limited to sites where:

- Inlet and outlet are not subject to significant scour or degradation of the natural ground.
- Inlet and outlet are free of obstructions such as riprap, rock baskets or an energy dissipator. **Headwalls and apron treatment shall not hamper access.**
- The slope through the structure does not exceed 4%.
- The approach is natural appearing--grades do not exceed 4-6%.

The invert of the stock pass structure should be relatively smooth with a natural appearance. At least 3 in. of soil over the bottom is desirable.

**Structural plate culverts shall have a paved invert which is relatively flat transverse to the centerline of the structure.** The flat surface should be not less than 3 ft wide for stock and equestrian passes and 8 ft wide for vehicle passes. The invert paving should meet the adjoining ground at the inlet and outlet; thus the culvert should be partially embedded. The invert paving should be in accordance with Construction Standard Drawing C-13.55.

**Structural plate culverts shall have headwalls.**

Headwalls and aprons should be installed to meet the grade of the paved inverts. Stock and equestrian passes should normally be less than 250 ft in length.

When passageways are required in conjunction with multiple barrel drainage installation, only one barrel needs to meet the requirement of a passageway.

## **612 - Erosion and Sediment**

### **612.1 - Erosion and Sediment Control Measures**

**Erosion and sediment control measures shall be designed in accordance with the provisions of [Section 113.1 - Stormwater Regulations for Construction Activities](#). The drainage designer shall coordinate with ADOT's erosion control specialists to ensure that the measures provided are in agreement with the requirements of ADOT Erosion and Pollution Control Manual<sup>9</sup>.**

### **612.2 - Erosion Control**

- A) *Channel linings:* Where the expected velocity, depth of flow or channel geometry would result in scour in an earth channel; a channel lining may be necessary. Linings may be either rigid or flexible. **All linings shall be designed to minimize their susceptibility to scour at their edges and terminals.** Generally smooth linings may result in high velocity flow requiring some form of energy dissipation.
- B) *Grade control structures:* **Grade control structures in roadside ditches shall only be used where they are located outside a recovery area or protected by guardrail or other appropriate safety barriers.** Grade control structures are very vulnerable to scour. Cutoff walls at both the upstream approach apron and the downstream splash apron are necessary to minimize the effects of scour and avoid undercutting.
- C) *Culvert outlet protection:* All culverts should be evaluated for determination of outlet protection. Drainage structures with a contributing drainage area of less than 160 acres in highly pervious areas will usually not require outlet protection. Drainage structures with a contributing drainage area greater than 160 acres will need an evaluation of outlet protection needs.

While the outlet velocity is the predominant factor in determining the potential need for and type of outlet protection, the ratio of the outlet velocity to the natural stream velocity can be used as a guide to determining the actual need for protection.

- No protection is generally required in the natural stream if the outlet velocity is less than 1.5 times the natural stream velocity.
- Dumped rock riprap is generally sufficient for ratios between 1.5 and 2.0 with an outlet velocity less than 10 fps.
- Wire-tied rock riprap should generally be used where the ratio is 1.5 to 2.5 with an outlet velocity between 10 and 15 fps.
- Energy dissipators are required when the ratio between outlet and natural stream velocities is greater than 2.5 or the outlet velocity is greater than 15 fps.

*D) Energy Dissipators:* The objective of an energy dissipator is to return the flow at the downstream outlet to a condition which approximates the natural flow regime. When required, the following types of energy dissipator should be considered: hydraulic jump basin, forced hydraulic jump basin, impact basin, drop structure, stilling well, and riprap basin. The design of energy dissipators should be as outlined in the ADOT Hydraulics Manual<sup>2</sup>.

## **613 - Bank Protection**

### **613.1 - General**

Bank protection should be provided to direct flows and protect banks, channels, spur dikes, levees and roadway embankment from scour. **Bank protection shall not be used in lieu of adequate foundation embedment for new bridges.** Remedial bank protection may be necessary at existing bridges. The selection of bank protection is to be guided by the function the protection is to provide. Functionally, armor is used to resist the force of the stream flow, retards are used to reduce the force of the flow, while jetties and guide dikes are used to divert the force of the stream.

### **613.2 - Design Considerations**

Bank protection should be designed to accommodate and withstand the effects of the design flow. Scour and velocity should be computed for conditions which can cause the largest value of each considering the site conditions.

The foundation or bottom limits of the bank protection should extend sufficiently below the channel thalweg to be stable for the anticipated scour.

**The top limit of armoring shall be selected with consideration of the effects of overtopping. Armoring protection which would be damaged by overtopping shall have freeboard provided for the design flow.** Where the protection can withstand inundation and

the remaining unprotected bank can resist the erosive effects of the current, the elevation of the bank protection should be selected as appropriate for the site. In all cases, the bank protection system must be viable for the environment in which it is situated. **Thus, plain wire-tied systems shall not be used in a corrosive environment.** The design of bank protection should be as outlined in the ADOT Hydraulics Manual<sup>2</sup> and as detailed in the Construction Standard Drawing C-17 series.

### 613.3 Riprap Design

Riprap Design is included in the ADOT Hydraulics Design Manual<sup>2</sup>.

## **614 - Pump Stations**

### 614.1 - General

For a depressed roadway, where gravity drainage is infeasible, a pump station with a storage reservoir should be provided. The purpose of the reservoir is to reduce the peak discharge to be pumped and to reduce initial capital and long-term operational costs of the pump station.

**The design of pump stations shall be as outlined in the ADOT Hydraulics Manual<sup>2</sup>.**

Off-site flows should be intercepted and directed away from the depressed roadway. The catchment area for the pump station is to be minimized. A large storage reservoir can reduce the pump station cost but at what may be a significant cost for the reservoir. The size and location of the storage reservoir should be carefully investigated to provide the most cost-effective design for both the storage reservoir and pump station.

**The design solution shall be documented through inflow and outflow hydrographs and accumulated inflow and outflow curves together with site layout and preliminary cost estimates early in the design process.**

### 614.2 - Storage Reservoirs

Storage can be accommodated within enlarged collecting drains located near or under the outside shoulder, or in the depressed infield of an interchange. Storm drains of depressed roadways must flow into the reservoir by gravity. Maximum use of surface storage, instead of underground storage, is desirable for minimizing storage costs. **Volumes of cross pipes, inlets, manholes or catch basins shall not be considered as part of the available storage reservoir volume.**

### 614.3 - Storage Reservoir Routing

The minimum design of the pump station and storage reservoir is to be based on design frequencies given in Table 603.2A. An inflow hydrograph for the design of the storage reservoir should be determined using a hydrograph-based method in accordance with the

ADOT Hydrology Manual. The use of HEC-1 is not appropriate for the design of pumping stations. A real-time procedure which routes the design inflow hydrograph using pump on and off elevations, and actual pump performance curves must be used.

The size of storage reservoir will be determined through reservoir routing by successive trials until the most appropriate results are obtained. Maximum storage will be determined from the accumulated inflow and outflow curves. The maximum water level in surface storage should not exceed the level of 2 ft below the lowest pavement elevation. The volume contained in the wet well can be counted as storage.

#### **614.4 - Pump Capacity**

Pump capacity should be determined for each time increment during the storage reservoir routing based on the water level in the storage reservoir. It is more economical to size the pumps according to the performance charts of those that are readily available.

#### **614.5 - Layout of Pump Stations**

**The site layout shall consider adequate access to refill fuel tanks, remove pumps and generators, and provide adequate aesthetics and mitigation of on-site noise.**

**Chapter 600 Drainage Reference List**

1. Hydrology Manual. Arizona Department of Transportation: Current Edition.
  2. Hydraulics Manual. Arizona Department of Transportation: Current Edition.
  3. Location Manual. Arizona Department of Transportation: Current Edition.
  4. Pipe Selection Guidelines and Procedures.
  5. Standard Specifications for Road and Bridge Construction. Arizona Department of Transportation: Current Edition.
  6. Hydraulic Design of Highway Culverts. Hydraulic Design Series No. 5. Federal Highway Administration: Current Edition.
  7. Evaluating Scour at Bridges, Highway Engineering Circular No. 18. Federal Highway Administration: Current Edition.
  8. Erosion and Pollution Control Manual. Arizona Department of Transportation: Current Edition.
  9. Hydraulic Design of Energy Dissipators for Culverts and Channels. Hydraulic Engineering Circular No. 14. Federal Highway Administration: Current Edition.
-

---

## CHAPTER 600

### DRAINAGE GLOSSARY

*Capacity Design (Drainage).* Design of open channel or pipe capacity, by satisfying the design criteria of energy grade line, hydraulic grade line, or freeboard, etc.

*Capacity, Full (Hydraulics).* Maximum capacity of an open channel equivalent to the discharge determined for bank-full elevation. Also the full flow capacity of a pipe with given energy gradient.

*Catch Basin.* A chamber or well usually built at the curb line of a roadway for the admission of surface water to a storm sewer or sub-drain.

*Culvert.* A closed conduit, other than a bridge, which carries water usually from a natural channel transversely under the roadway.

*Culvert, Flexible.* A culvert constructed of a material permitting a five percent minimum change in vertical and horizontal dimensions before failure.

*Culvert, Rigid.* A culvert constructed of a material not permitting appreciable cross-sectional distortion without failure.

*Depressed Roadway.* The roadway in a sag whose ultimate ponded depth, under the assumption of no outlets at the sag, is more than 2.5 feet.

*Detention Basin.* A basin or reservoir wherein water is stored for a relatively brief period of time part of it being detained until the downstream channel can safely carry the ordinary flow plus the released water. Such basins usually have gravity-flow outlets without control gates and are used for flood regulation.

*D-Load.* The supporting strength of a pipe loaded under three-edge-bearing test load to produce a 0.01 inch crack expressed in pounds per lineal foot per foot (lbs/ft/ft) of inside diameter or horizontal span.

*Ditch.* A small open channel constructed below grade used for collecting and conveying surface drainage. Cut ditches are generally parallel to and adjacent to the outside shoulder of a roadway. Median ditches run generally parallel to the roadway within the median of a divided highway. Ditches generally have alignments which are dependent upon the roadway alignment.

*Drainage Area.* The area that contributes storm water to a point of interest such as lake, stream or drainage system; also called a catchment area.

*Drainage Plan.* A design for the disposition of roadway pavement and surface drainage.

*Drainage System.* See Storm Drainage System.

*Encroachment (Drainage).* That portion of the roadway that would be spread or inundated by storm water, of design frequency, flowing along the roadway.

*Energy Dissipator.* A device to dissipate excess kinetic energy possessed by flowing water.

*Energy Gradient.* Slope of the energy grade line.

*Energy Grade Line.* A line joining elevations of the energy heads; a line drawn above the hydraulic grade line a distance equivalent to the velocity head of the flowing water at each section along a stream, channel, or conduit.

*Flood Channel.* A channel, lined or unlined, which is used to convey flood waters.

*Freeboard.* The vertical distance between a point on the water surface and the bottom of a structure directly above; the vertical distance between the water surface and the top of the bank immediately adjacent. For a structure, the critical freeboard is usually at the lowest point of the structure over water.

*Frequency.* In analysis of hydrologic data, the recurrence interval is called frequency. See Recurrence Interval.

*Froude Numbers (Fr).* A dimensionless expression of the ratio of inertia forces to gravity forces, used as an index to characterize the type of flow in a hydraulic structure in which gravity is the force producing motion and inertia is the resisting force. It is equal to a characteristic flow velocity divided by the square root of the product of a characteristic dimension and the gravity constant expressed as:

$$Fr = \frac{V}{(gy)^{0.5}}$$

In open channel flow, V= average velocity and y= hydraulic depth -- the cross-sectional area of the water normal to the direction of flow divided by the width of the free surface.

*Headwater, Design. (DH)* The elevation of culvert inlet ponding, above the invert, for the given storm interval, culvert type, size, and discharge. This elevation is shown in the plans for each culvert.

*Hyetograph.* A graphical representation of average rainfall, rainfall-excess rates or volumes over specified areas during successive units of time during a storm.

*Hydraulic Grade Line.* A hydraulic profile of the piezometric level of water at all points along the line. The term is usually applied to water moving in a conduit, open channel, stream, etc., but may also be applied to ground water, free or confined. In an open channel it is the free water surface.

*Inflow Hydrograph.* A hydrograph of inflow into a reservoir or drainage structure.

*Inlet.* An opening that collects roadway surface runoff to a drain or storm sewer.

*Invert.* The lowest point of the internal cross section of a closed conduit or channel.

*Permeability.* The degree to which a soil will permit the passage of water.

---

*Pumping Station.* A facility housing stormwater pumps, controls, power plants and their appurtenances.

*Rainfall Intensity.* The amount of precipitation occurring in a unit of time, generally expressed in inches per hour.

*Rational Method.*  $Q=CIA$ , where Q is the peak discharge in cubic feet per second (cfs), C is the runoff coefficient, depending on the characteristics of the drainage area, I is the uniform rate of rainfall intensity in inches per hour for a duration equal to the time of concentration, and A is the drainage area in acres. The rational method is generally not used for drainage areas greater than 160 acres.

*Recurrence Interval.* The average time interval between actual occurrences of a hydrological event of a given or greater magnitude. The percent chance of occurrence is the reciprocal of flood frequency, e.g., a two percent chance flood is the reciprocal statement of a 50-year flood. Also called return period, exceedance interval, or frequency.

*Regulatory Floodplain.* That portion of the floodplain that would be inundated by the Regulatory Flood and those areas that are subject to sheet flooding. Regulatory Flood means 100-year flood, that was adopted by the Federal Emergency Management Agency (FEMA) as the base flood for flood plain management purposes.

*Retention Basin.* A basin or reservoir wherein water is stored for regulating a flood, however, it does not have gravity-flow outlets for outflows during floods as detention basins do. The stored water must be disposed by some other means such as by infiltration into soil, injection (or dry) wells, or pumping systems.

*Riprap.* Broken stone or boulders placed compactly or irregularly on dams, levees, dikes, outlets and inlets of hydraulic structures, etc., for protection of earth surfaces against the action of waves or currents.

*Storage Reservoir of Pump Station.* A reservoir wherein peak flows from storm drains are stored for reducing capacity requirements of the pump station to pump runoff to an appropriate outlet.

*Storm Drain.* A drain used for conveying rain water, ground water, subsurface water, condensate, cooling water, or other similar discharge. Also known as storm sewer.

*Storm Drainage System.* A system for collecting runoff of storm water on highways and removing it to appropriate outlets. The system includes inlets, catch basins, storm sewers, main drains, lateral pipe, storage reservoirs, detention basins and pump stations.

*Thalweg.* A line following the lowest points of a valley.

*Time of Concentration.* The time, for a given storm interval, that is required for runoff to reach a point under consideration from the most remote part of a drainage area. It is not a constant, but varies with the depth of flow and condition of the channel.

## CHAPTER 700 EARTHWORK DESIGN

### Table of Contents

|                                      |  |       |
|--------------------------------------|--|-------|
| 701 – Introduction                   |  | 700-1 |
| 701.1 -- Purpose                     |  | 700-1 |
| 701.1.1 -- Earthwork Design Approach |  | 700-1 |
| 701.2 -- Requirements                |  | 700-2 |
| 701.3 -- Process Description         |  | 700-3 |
| Roadway Template                     |  | 700-3 |
| Determining Quantities               |  | 700-3 |
| 701.4 -- Definitions/Concepts        |  | 700-7 |

### Types of Excavation

|                              |        |
|------------------------------|--------|
| Roadway Excavation           | 700-7  |
| Drainage Excavation          | 700-7  |
| Channel Excavation           | 700-7  |
| Structural Excavation        | 700-7  |
| Pipe Excavation              | 700-7  |
| Topsoil Excavation           | 700-7  |
| Topsoil                      | 700-7  |
| Landscape Excavation         | 700-8  |
| MSE Wall Excavation          | 700-8  |
| Overexcavation               | 700-8  |
| Collapsible Soils            | 700-8  |
| Benching (Fill Slopes)       | 700-8  |
| Benching (Cut Slopes)        | 700-8  |
| Mini-benching (Cut Slopes)   | 700-8  |
| Borrow                       | 700-9  |
| Waste                        | 700-9  |
| Grading Roadway for Pavement | 700-9  |
| Haul Out                     | 700-9  |
| Haul In                      | 700-10 |

### Types of Embankment

|                    |        |
|--------------------|--------|
| Roadway Embankment | 700-10 |
| Ground Compaction  | 700-10 |
| Dikes and Berms    | 700-10 |
| Plating            | 700-10 |

### Other Items

|  |        |
|--|--------|
| Shoulder Build-up  | 700-14 |
| Guardrail Related Earthwork                                  | 700-14 |
| Pipe Backfill and Trench Backfill                            | 700-14 |
| Bedding  | 700-15 |
| Structure Backfill   | 700-15 |
| MSE Wall Backfill  | 700-15 |
| Culvert Quantity Adjustments (Pipe Culvert and Box Culverts) | 700-15 |

---

|   |        |
|---|--------|
| Existing Roadway Pavement Structure                         | 700-16 |
| Slope Rounding  | 700-16 |
| Balanced Earthwork Project                                  | 700-16 |
| Balanced Earthwork Quantities                               | 700-17 |
| 702 – Existing Ground Data                                  | 700-17 |
| 702.1 - Cross Sections                                      | 700-17 |
| 702.2 - Field Surveyed Cross Sections                       | 700-17 |
| 702.3 - Digital Terrain Modeling                            | 700-19 |
| 702.4 - Photogrammetry                                      | 700-19 |
| 702.5 - Phased Construction Groundline                      | 700-20 |
| 703 – Templates   | 700-22 |
| 703.1 - General   | 700-22 |
| 703.2 - Urban Highways                                      | 700-22 |
| 703.3 - Rural Highways                                      | 700-22 |
| 703.4 - Special Conditions                                  | 700-22 |
| 703.5 - Plating   | 700-22 |
| 703.6 - Topsoil Excavation                                  | 700-22 |
| 704 – Slopes  | 700-29 |
| 704.1 - General   | 700-29 |
| 704.2 - Materials Design Report                             | 700-29 |
| 704.3 - Cut Slopes  | 700-29 |
| 704.4 - Fill Slopes   | 700-29 |
| 704.5 - Contour Grading                                     | 700-32 |
| 705 – Drainage Related Earthwork                            | 700-32 |
| 705.1 - General   | 700-32 |
| 705.2 - Channels and Dikes                                  | 700-32 |
| 705.3 - Pipe Backfill, Trench Backfill and Bedding          | 700-32 |
| 705.4 - Structural Backfill                                 | 700-32 |
| 705.5 - Pipe Excavation and Structure Excavation            | 700-32 |
| 706 – Material Factors                                      | 700-37 |
| 706.1 - Shrinkage and Swell                                 | 700-37 |
| 706.2 - Ground Compaction                                   | 700-37 |
| 707 – Miscellaneous Earthwork                               | 700-38 |
| 707.1 - Unsuitable Materials                                | 700-38 |
| 707.2 - Turnouts  | 700-38 |
| 707.3 - Cross Roads   | 700-38 |
| 707.4 - Rest Areas  | 700-38 |
| 707.5 - Interchanges  | 700-38 |
| 707.6 - Bridges   | 700-38 |
| 707.7 - Detours   | 700-39 |
| 707.8 - Roadway Connections                                 | 700-39 |
| 707.9 - Mechanically Stabilized Earth (MSE) Retaining Walls | 700-39 |
| 708 – Mass Diagram  | 700-40 |
| 709 – Documentation Requirements                            | 700-43 |
| 709.1 - Earthwork to be Shown on the Plans                  | 700-43 |
| Final Earthwork Summary                                     | 700-43 |
| Top Soil Excavation Limits                                  | 700-43 |
| 709.2 - Earthwork Documentation                             | 700-45 |

|   |        |
|---|--------|
| A) Documentation of Quantities (Provided in a booklet)    | 700-45 |
| 1) Station-to-Station Listing of Quantities               | 700-45 |
| 2) Other Earthwork Supporting Quantities and Calculations | 700-45 |
| 3) Plotted Cross Sections                                 | 700-45 |
| 710 – Quality Procedures                                  | 700-46 |
| 711 – Software  | 700-46 |
| 712 – Other Considerations                                | 700-46 |
| Constructability Issues                                   | 700-46 |

### LIST OF FIGURES

|               |   |        |
|---------------|---|--------|
| Figure 701.3A | Roadway Template                                    | 700-5  |
| Figure 701.3B | Cut and Fill Cross Sections                         | 700-6  |
| Figure 701.4A | Typical Benching (Fill Slopes)                      | 700-11 |
| Figure 701.4B | Typical Benching (Cut Slope)                        | 700-12 |
| Figure 701.4C | Ground Compaction Applications                      | 700-13 |
| Figure 702.1  | Additional Cross Section Locations                  | 700-18 |
| Figure 702.5  | Phased Construction Ground Lines                    | 700-21 |
| Figure 703.1  | Template Widths Through Superelevated Sections      | 700-23 |
| Figure 703.2  | Urban Template                                      | 700-24 |
| Figure 703.3  | Rural Template                                      | 700-24 |
| Figure 703.4A | Tangent Roadway and Superelevated Roadway Templates | 700-25 |
| Figure 703.4B | Ramp Templates                                      | 700-26 |
| Figure 703.4C | Rounding  | 700-27 |
| Figure 703.5  | Plating and Topsoil Excavation (Urban Freeways)     | 700-28 |
| Figure 704.3A | Fill-to-Cut Shoulder Transitions                    | 700-30 |
| Figure 704.3B | Sliver Cut and Fills                                | 700-31 |
| Figure 704.5  | Contour Grading                                     | 700-33 |
| Figure 705.3  | Storm Drains and Pipeline Excavation                | 700-34 |
| Figure 705.4  | Structure Backfill Payment Limits                   | 700-35 |
| Figure 705.5  | Structural Excavation Payment Limits                | 700-36 |
| Figure 708.1  | Relationship Between Profile and Mass Diagram       | 700-41 |
| Figure 709.1  | Earthwork Summary Table Quantity Check              | 700-44 |

### APPENDIX B      EARTHWORK EXAMPLES

Basic Earthwork Calculations  
 Earthwork Calculations Project Examples  
 Quantity Summary Table Examples  
 Cross Section Examples  
 Pipe Excavation and Backfill Computations  
 Urban Highway Earthwork Calculations Example  
 Topsoil Excavation Examples  
 Contour Grading Examples  
 MSE Wall Examples



## CHAPTER 700

### EARTHWORK DESIGN

#### 701 - Introduction

##### 701.1 - Purpose

This chapter has been developed to provide a uniform and consistent approach to the calculation of earthwork volumes and plan quantities.

Use of this guideline is recommended for all phases of highway project development from conceptual designs through final construction plans.

It is the responsibility of the roadway designer to accurately compute earthwork quantities. Earthwork quantities are a critical part of estimating the cost of a project.

Computer software has been developed that has improved the ability of the designers to consider various design alternatives. The designer is encouraged to use the computer produced earthwork information in a feedback process of improving the design and reducing construction costs.

##### 701.1.1 - Earthwork Design Approach

The objective in providing good earthwork plans for a project is for the designer to determine the constructability of the project and then to present the earthwork summary of quantities for the project in a thorough and logical format. The designer should first become as thoroughly familiar with the project as possible by reviewing all of the project scoping documents available and visiting the project site. This is how he can begin to evaluate how the project will be constructed. Things to be observed and taken into account affecting constructability will include:

- a) The number of roadways to be constructed;
- b) How will traffic negotiate the new construction area; what type of construction phasing or detouring is needed;
- c) Is the new project right-of-way private or public land; in most cases, material cannot be removed from private land or royalties must be paid;
- d) Type of material; is the project primarily a borrow, waste, or balanced earthwork project (See Definitions/ Concepts);
- e) Where are the sources for materials for the project or potential waste sites;
- f) Are there high cuts, high fills, retaining wall areas and special areas of geotechnical investigation required;
- g) Where are the major structures and drainage courses;

- 
- h) What environmental restrictions and mitigation measures will be required: cultural, biological, wetlands, noise and air quality issues, water quality;
  - i) Are there special requirements for slopes by land owners;
  - j) What is the availability of water for the project; and
  - k) Utility involvement.

After considering these and other potential issues affecting earthwork, the designer is ready to begin the process of earthwork design. Close coordination with the other Groups involved is essential, primarily involving Materials, Traffic, and District but also including Environmental, Forest Service or other owner, Bridge, Right-of-Way, Roadside Development, and Utilities.

### 701.2 - Requirements

Earthwork calculations may be done manually or by using computer programs or a combination of both.

ADOT does not have any requirement for a specific earthwork computer program, but the selected programs computation of volumes will have to be made by the average-end-area method. See [Section 709](#) for the documentation and requirements of the program.

The following Earthwork Pay Items will have to be calculated and documented in a manner described later in this guide:

- Roadway Excavation
- Drainage Excavation
- Channel Excavation
- Structural Excavation
- Topsoil Excavation
- Topsoil (Placement)
- Landscape Excavation
- Plating (Landscape Borrow or Top Soil) (Landscaping Projects)
- Borrow
- Grading Roadway for Pavement
- Structure Backfill
- Shoulder Build-up (Earthen)

The following earthwork items should also be calculated and documented as required. These quantities are normally included in other pay items. Pay item noted in ( )'s.

- Overexcavation (Roadway Excavation)
- Collapsible Soils (Roadway Excavation)
- Pipe Excavation (Pipe Culvert Cost)
- Benching (Fill Slopes) (Not a Pay Item)
- Benching (Cut Slopes) (Part of Roadway Excavation, but in special cases, may be a separate Pay Item)

- Waste (Not Pay Item)
- Roadway Embankment (Not Pay Item)
- Ground Compaction (Not Pay Item)
- Dikes and Berms (Not Pay Item)
- Haul In (Not Pay Item)
- Haul Out (Not Pay Item)
- Bedding (Not Pay Item)
- Pipe Backfill (Not Pay Item)
- Trench Backfill (Not Pay Item)
- Culvert Quantity Adjustment (Pipe Culvert and Box Culvert)
- MSE Wall Excavation (Not a separate pay item; included in SF bid item for MSE Wall)
- Reinforced Backfill (For MSE Walls; not a pay item; included in SF bid item for MSE Wall)
- Retained Backfill (For MSE Walls; not a pay item; included in SF bid item for MSE Wall)

Earthwork computations shall be in compliance with ADOT's Standard Specifications, Sections 203 Earthwork, 501 Pipe Culvert and Storm Drains, 801 Landscape Excavation, 802 Landscape Grading, 803 Landscape Plating Materials, and 804 Topsoil.

### 701.3 - Process Description

#### **Roadway Template:**

The first step in determining the amount of earthwork that is required on a highway project is to establish the physical characteristics of the facility. This is done by determining the "cross section template" for the highway. The template will determine the roadway width, the depth of ditches, the slopes, the back slopes, shoulder widths, etc. The template will show the different treatments for excavation (cut) areas and embankment (fill) areas. Both cut and fill sections are illustrated in [Figure 701.3A](#).

The template section is overlaid on cross sections of the existing ground along the proposed alignment. The elevation of the road surface in the template is set by the design profile. The cross section allows the Engineer to determine area of cut and fill.

#### **Determining Quantities:**

The next step in estimating roadway earthwork requirements is to calculate the amount of cut and fill. Quantities are measured in terms of their volume in cubic yards. The process by which this is accomplished, whether done manually or by computer, is quite standard.

The process is illustrated in [Figure 701.3B](#), where a short section of road is represented by three cross sections. The area of the fill cross sections are shown as  $F_1$ ,  $F_2$  and  $F_3$ . These areas are measured in square feet. The distance between cross sections 1 and 2 is "L" (in ft). The volume of embankment in this segment is calculated using the average-end-area method, as presented by the formula:

$$V = \left[ \frac{A_1 + A_2}{2} \right] L \div 27$$

(See [Figure 701.3B](#))

Where  $V$  is the volume (in Cu.Yd.) between cross sections 1 and 2 with fill areas  $A_1$  and  $A_2$ . Adjustments such as shrinkage, swell and ground compaction are made depending on the type of material present in the section being computed. **ADOT does not adjust earthwork quantities to compensate for roadway curvature.** Additional details of these adjustments are described in other Sections of this chapter.

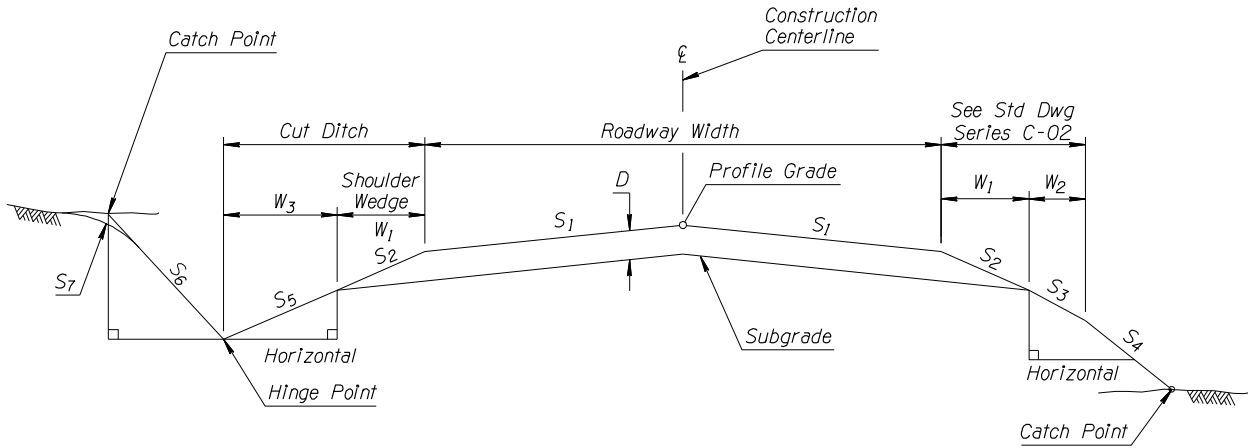

**LEGEND**

- D = Structural Section Depth, Excluding ACFC*
- W<sub>1</sub> = D x S<sub>2</sub>*
- W<sub>2</sub> = Additional Width Required by Std Dwg Series C-02 When Guardrail Is Used*
- W<sub>3</sub> = Cut Ditch - W<sub>1</sub>*
- S<sub>1</sub> = Roadway Slope (Subject to Superelevation Rotation)*
- S<sub>2</sub> = Shoulder Wedge Slope (Nominal 6:1 or 4:1 In Relation To Roadway Slope)*
- S<sub>3</sub> = See Std Dwg Series C-02 (In Relation to Horizontal)*
- S<sub>4</sub> = Fill Slope - As Per Plans (In Relation to Horizontal)*
- S<sub>5</sub> & S<sub>6</sub> = Cut Ditch, Foreslopes & Backslopes As Per Plans (In Relation to Horizontal)*
- S<sub>7</sub> = Slope Rounding (Cut Only), See Std Dwg Series C-02*
- Roadway Width = Traffic Lanes + Paved Shoulder Width*
- Profile Grade = As Per Plans*
- Subgrade = Profile Grade - D*

**ROADWAY TEMPLATE  
FIGURE 701.3A**

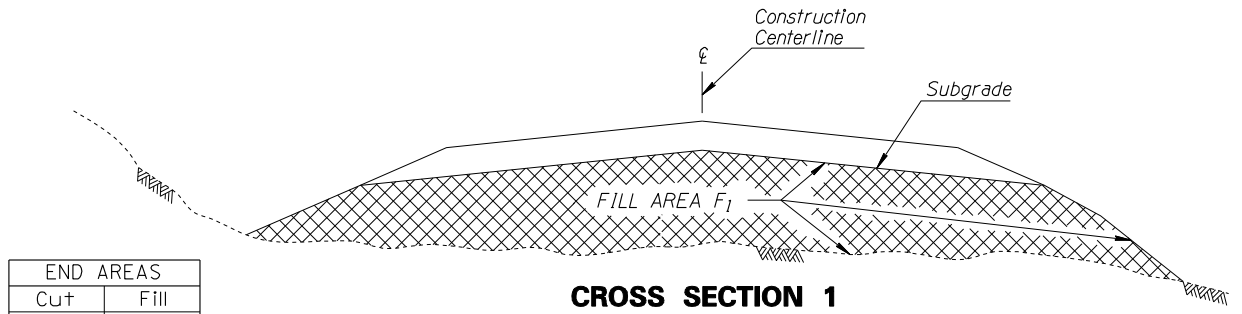

| END AREAS |       |
|-----------|-------|
| Cut       | Fill  |
| $C_1 = 0$ | $F_1$ |

**CROSS SECTION 1**

(DISTANCE =  $L_1$ )

|   |
|---|
| Cut Volume ( $V_C$ )  |
| $V_C = \left[ \left( \frac{C_1 + C_2}{2} \right) \right] L_1 \div 27$ |
| Fill Volume ( $V_F$ )   |
| $V_F = \left[ \left( \frac{F_1 + F_2}{2} \right) \right] L_1 \div 27$ |

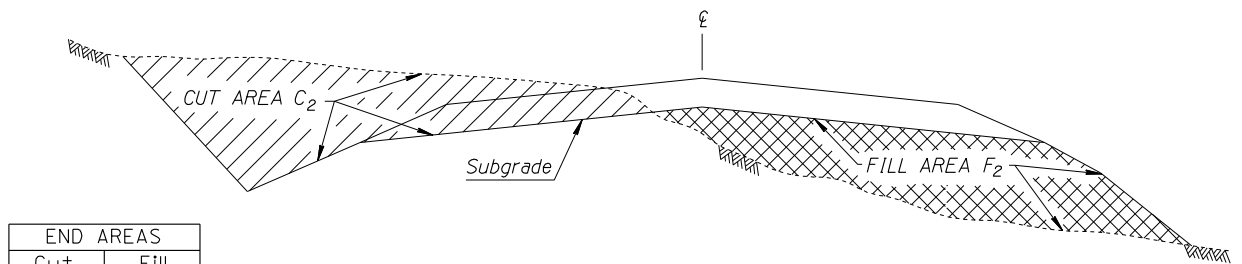

| END AREAS |       |
|-----------|-------|
| Cut       | Fill  |
| $C_2$     | $F_2$ |

**CROSS SECTION 2**

(DISTANCE =  $L_2$ )

|   |
|---|
| Cut Volume ( $V_C$ )  |
| $V_C = \left[ \left( \frac{C_2 + C_3}{2} \right) \right] L_2 \div 27$ |
| Fill Volume ( $V_F$ )   |
| $V_F = \left[ \left( \frac{F_2 + F_3}{2} \right) \right] L_2 \div 27$ |

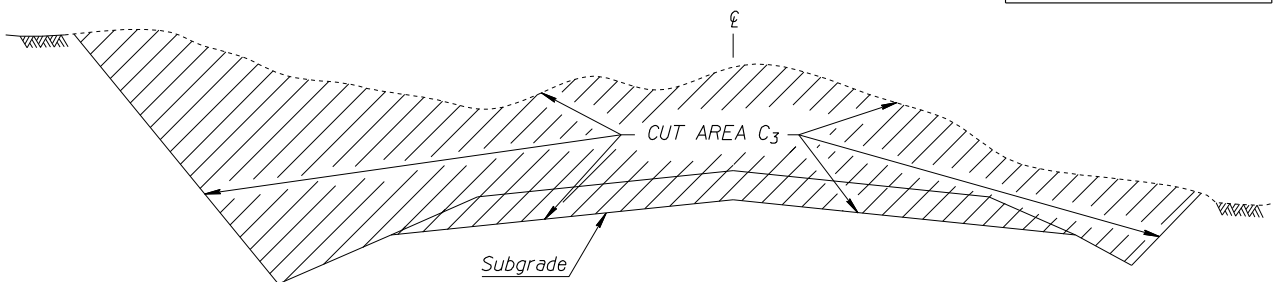

| END AREAS |           |
|-----------|-----------|
| Cut       | Fill      |
| $C_3$     | $F_3 = 0$ |

**CROSS SECTION 3**

**CUT & FILL CROSS SECTIONS  
FIGURE 701.3B**

## 701.4 - Definitions/Concepts

### Types of Excavation (Pay Items are indicated with an asterisk)

**\*Roadway Excavation:** (Standard Specifications Section 203-3) Roadway excavation shall consist of excavating, grading and hauling all types of materials encountered in constructing the roadway, lookouts, parking areas, turnouts, driveways, and cut ditches within the roadway and other road-related areas as designated on the project plans or specified in the Special Provisions; and the placement and compaction of the excavated material in embankments. The over-excavation of unsuitable material is considered to be part of roadway excavation and should be included with roadway excavation quantity totals. Topsoil excavation quantity, when it occurs within the limits of the project, is to be included with the roadway excavation quantities.

**\*Drainage Excavation:** (Standard Specifications Section 203-4) Drainage excavation shall consist of the excavation of minor ditches, minor channels or minor waterways except that excavation which is required to construct ditches paralleling the roadway and constituting a part of the roadway prism shall be considered as roadway excavation. Drainage facilities having bottom widths of 10 ft or less shall be classified as drainage excavation. The limits of the drainage excavation should be clearly shown on the project plans. A typical section, horizontal, and vertical geometry may be required on some drainage facilities, if critical to drainage control.

**\*Channel Excavation:** Channel excavation shall consist of the excavation of major ditches, major channels or major waterways. Drainage facilities having bottom widths greater than 10 ft shall be classified as channel excavation. The limits of the channel excavation should be clearly shown on the project plans. A typical section supported by horizontal and vertical geometry is **required** on all drainage facilities classified as channel excavation.

**\*Structural Excavation:** Structural excavation shall consist of the excavation and removal of all materials necessary for the construction of bridges, box culverts, inlet and outlet wings, retaining walls or other specific items designated on the project plans or in the Special Provisions as structural excavation.

**Pipe Excavation:** (Standard Specifications Section 501) Pipe excavation shall consist of the excavation required for the installation of pipe culverts and storm drains. The limits of the pipe excavation shall be in accordance with the details in the standards or as specified in the project plans. Pipe excavation is not a separate pay item and is paid for as part of the pipe culvert or storm drain. Quantities are shown on the plans for information purposes.

**Topsoil Excavation:** Topsoil excavation shall consist of the excavation and stockpiling of suitable native topsoil material that exists within the right-of-way limits of the project. The topsoil excavation is to be stockpiled and shall be the source of material to plate the embankment slopes when plating is required on the project. The determination on the suitability of the native material shall be coordinated with Roadside Development and the appropriate District personnel. Topsoil excavation quantities shall be paid for as part of roadway excavation.

**\*Topsoil:** (Standard Specifications Section 804) Topsoil shall consist of furnishing, hauling and placing topsoil in accordance with the details shown on the project plans. Use of this item shall be coordinated with Roadside Development and the appropriate District personnel.

---

**\*Landscape Excavation:** (Standard Specifications Section 801) Landscape excavation shall consist of excavating areas to be landscaped, hauling, placing, and disposal of surplus excess material in accordance with the details shown on the project plans. Use of this item shall be coordinated with Roadside Development and the appropriate District personnel.

**MSE Wall Excavation:** MSE Wall excavation consists of the excavation of materials required to construct the retaining wall as shown on the plans details, and includes grading, hauling, placement and compaction of the material in embankments shown on the plans. There is no separate pay item for MSE Wall Excavation; payment is included in the square-foot bid price for MSE retaining wall.

**Overexcavation:** Overexcavation shall consist of the excavation and grading of unsuitable material below the finished subgrade elevation. The actual limits of the overexcavation shall be clearly shown vertically and horizontally on the project plans. Overexcavation is not a separate pay item, unless the project does not include roadway excavation. Normally, overexcavation is included in roadway excavation. The Materials Design Memorandum shall identify the requirements of the overexcavation. The Materials Design Memorandum shall also identify the source of the material to replace the unsuitable material removed. Overexcavated material may or may not be suitable for placement within the embankment. The project plans should clearly identify the requirements (to be wasted or placed in deep embankment areas) of the removed unsuitable material.

**Collapsible Soils:** Collapsible soils shall be treated in a manner similar to overexcavation. See the Materials Design Memorandum for the requirements.

**Benching (Fill Slopes):** When constructing new embankments on existing embankments, fill slopes, or hillsides, benching (see [Figure 701.4A](#)) may be required in order to key-in the new embankment to minimize the possibility of slippage at the interface. A determination of the need for benching at each location should be made by the designer in consultation with Geotechnical Services and construction personnel. All areas that are determined to require benching shall be clearly designated on the plans. If a specific treatment is recommended at a given site, details should be shown on the plans. When no specific detailed treatment is recommended and shown on the plans, benching treatments will be worked out at the project level in accordance with the Standard Specifications or the Special Provisions for the project. No separate measurement or payment will be made for excavating benches. This item does not include benches or other excavation that may be needed in solid rock since this type of work is roadway excavation and requires special equipment.

**Benching (Cut Slopes):** Benching of new cut slopes is a special design and is to be investigated and designed individually for each and every cut area where benching of the new cut slope is being considered. See [Figure 701.4B](#) for typical benching in cut slopes. Benching quantities are always calculated, and it is a pay item either as part of roadway excavation or as special benching excavation.

**Mini-Benching (Cut Slopes):** Mini-benching is used on long and steep slopes to promote vegetation growth and reduce erosion. Usage and details are determined on a project basis and shown on the plans. No separate measurement or payment is made for mini-benching. See [Figure 701.4B](#) for a typical application.

---

**\*Borrow:** (Standard Specifications Section 203-9) Borrow shall consist of furnishing and placing suitable material obtained from sites outside of the project right-of-way for use in embankments, shoulders, berms, dikes and other similar purposes. Material obtained from within the project right-of-way shall be considered as roadway excavation, not borrow. The borrow quantity may be paid for using one of the two following pay items:

**Borrow (Pit):** This source of borrow is identified in the Materials Design Report and is available for use on the project. The borrow is computed in the original space occupied and volume of material removed shall be computed by the average end area method.

**Borrow (In Place):** "In Place" borrow may be used when the source of potential borrow is not specified. It is a calculation of the embankment volume of material to fill the required "In Place" space. There are no adjustments for shrinkage.

"In Place" borrow is normally specified for urban projects where there are multiple sources of borrow that may be utilized; the contractor determines what sources are most beneficial to construct the project with materials meeting the specifications. Many times these sources are commercial pits with materials being hauled to multiple projects or sites. This makes measuring and documenting quantities at the source (as required for Borrow (Pit)) unrealistic.

Borrow (In Place) may be specified for any project where a relatively small quantity of borrow is needed and a source is not specified.

The designer utilizing Borrow (In Place) needs to assure that it is reasonable for the contractor to obtain a source through discussions with Materials Group and/or District.

**Waste:** (measured in its original space) is excavation that is not being used within the project and must be disposed of by the contractor in a manner approved by the Engineer. Material that is to be hauled to a designated location (on or off the project limits e.g. stockpile) is not identified as waste material.

**\*Grading Roadway for Pavement:** (Standard Specifications Section 205) Grading roadway for pavement is an alternate method of payment for the earthwork quantities when the design of the roadway is a reconstruction of the existing roadway pavement with little or no grade adjustments, and the work is primarily done between curbs and gutters in urban areas, with minimal shoulder work. This type of reconstruction normally requires very little excavation or embankment between the edges of the existing roadway and using roadway excavation as a pay item is not appropriate. The depth of the excavation or embankment should be approximately one ft plus-or-minus if the earthwork is to be paid for as grading roadway for pavement. If the lateral width of the grading exceeds the widths described above, a Special Provision is required describing measurement and payment limits.

**Haul Out:** is excavated material that is removed from a construction phase area and is designated for use in another construction phase area to meet embankment needs. The haul out quantity is the excavated material without adjustments for shrink or swell.

**Haul In:** is excavated material brought in to a construction phase area from another construction phase area to meet embankment needs. The haul in quantity is the excavated quantity of material, that when adjusted for shrink or swell, will provide the needed embankment. The haul out quantity from one construction phase is the same shown as the haul in quantity to the complementary phase. The haul in quantity is then shrunk or swelled as appropriate to provide the needed volume.

Normally, there is no separate pay for haul in or haul out. The cost is included in roadway excavation or other excavation.

A pay item for haul may be established on projects where special conditions warrant. Typically, this includes large quantities, with off-site hauls to designated locations.

### **Types of Embankment**

**Roadway Embankment:** (Standard Specifications Section 203-10) Embankment requirements shall apply to the construction of roadway embankments, including the widening of embankment sections with surplus material and the preparation of the areas upon which embankment material is to be placed; the construction of dikes and berms; the placing of material where unsuitable material has been removed; and the placing of material in holes, pits and other depressions within the roadway area.

**Ground Compaction:** Shall apply to the quantities of roadway embankment in areas where additional embankment material is required to compensate for the settlement of the existing ground below the new fill. **Ground compaction calculations shall apply to embankment areas only.** See [Figure 701.4C](#). The ground compaction factor (Depth) as shown in the Materials Design Report is to be used to calculate the additional embankment required. In areas where topsoil has been removed or overexcavation occurs, ground compaction is not applicable.

**Dikes and Berms:** Dikes and berms are considered additional embankment and the embankment requirements shall apply to the construction of dikes and berms.

**Plating:** These items are normally associated with landscaping projects when materials are brought in from off-site sources. See Standard Specifications Section 803 Landscape Plating Materials (landscape borrow) and Section 804 Topsoil.

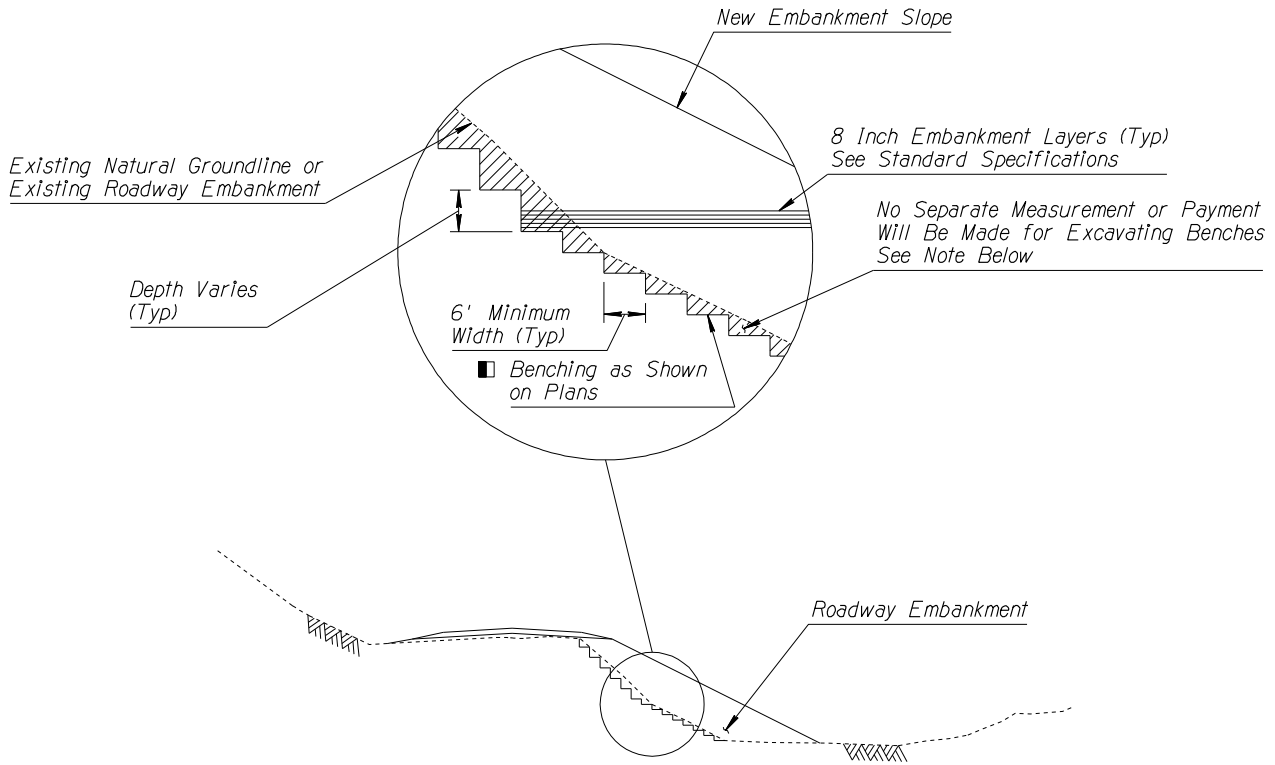

- See Standard Specifications for Road and Bridge Construction Section 203-10.03 (A)

*There Is No Direct Pay Item For Benching. Benching Excavation Is Considered Part of Other Pay Items*

*Note: A Special Provision Is Needed to Supplement Standard Specifications*

*See Geotechnical Report for Benching Requirements*

## **TYPICAL BENCHING (FILL SLOPES) FIGURE 701.4A**

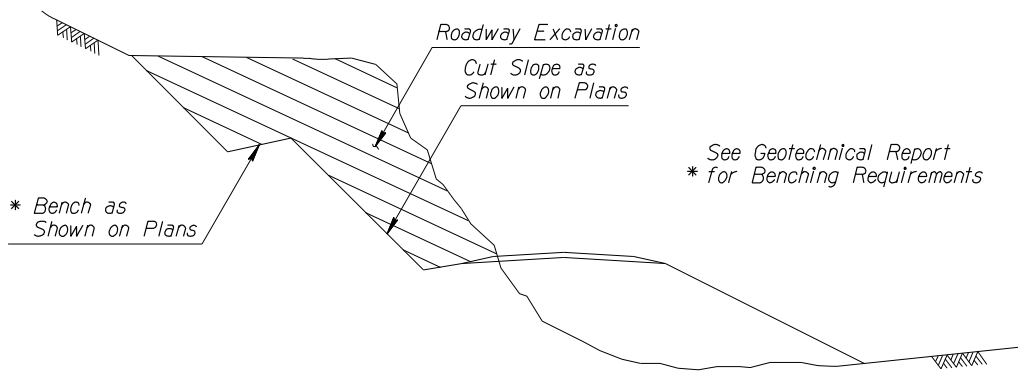

SPECIAL SLOPE BENCH

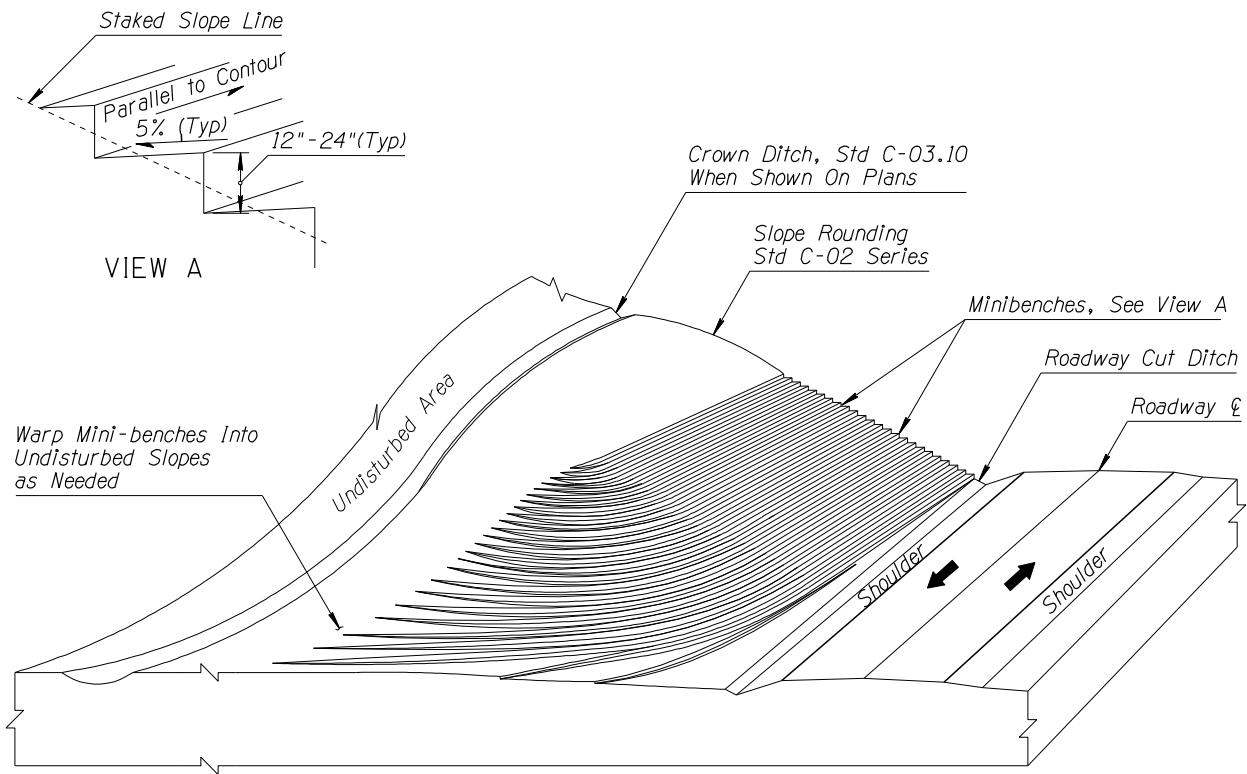

MINI-BENCHES

GENERAL NOTES

1. Construct Mini-benches horizontally and parallel to contour lines along entire cut. Apply slope rounding per Section 203 of the Standard Specifications.
2. The horizontal dimension of the bench is a function of the staked slope.
3. Apply seeding for revegetation and permanent erosion control as the slope is being constructed to conform to the application limits of the seeding/mulching equipment. Refer to Standard Specifications Section 805.

**BENCHING  
(CUT SLOPES)  
FIGURE 701.4B**

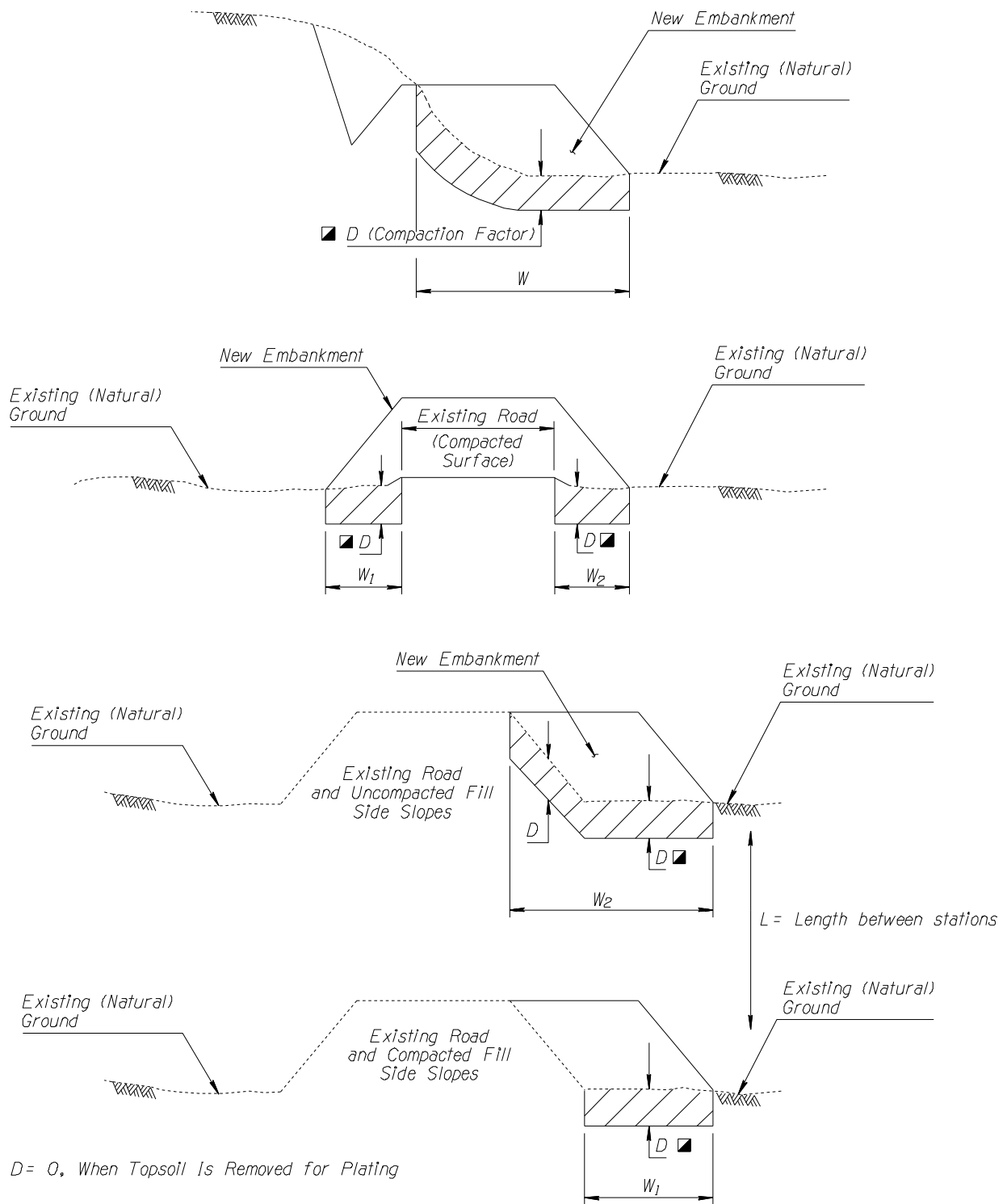

$$\text{Ground Compaction Volume C.Y.} = \frac{L \times D \times \left( \frac{W_1 + W_2}{2} \right)}{27}$$

**GROUND COMPACTION APPLICATIONS  
FIGURE 701.4C**

---

### **Other Items**

**\*Shoulder Build-up:** Shoulder build-up consists of furnishing, placing, and shaping materials along the edge of the pavement to achieve a smooth edge and eliminate drop-offs. Compaction of the build-up material is paid for under a separate pay item. Shoulder build-up is normally associated with pavement overlay projects. Materials selected for shoulder build-up may be obtained from earthen (roadway excavation or borrow) sources or from milled asphaltic concrete. Shoulder build-up is measured and paid for on a lineal foot basis along the pavement edge. The earthen quantities required for shoulder build-up are calculated and indicated on the plans for informational purposes. When earthen material is obtained from within the project and is part of other earthwork activities (e.g. cut widening) the quantity for shoulder build-up is accounted for in the Earthwork Summary. If milled AC is to be the source of shoulder build-up, the estimated AC quantity (in tons) is not normally an earthwork item but is shown on the plans for informational purposes. See Shoulder Build-up Design Guidelines in the ADOT [Guidelines for Scoping Pavement Preservation Projects](#).

**Guardrail Related Earthwork:** Embankment quantities required for guardrail work are to be calculated and reflected in the earthwork summary. Embankment material for the flares at guardrail end treatments and any miscellaneous embankment quantities associated with pavement widening for special guardrail treatments should also be included. The quantities vary depending upon the details utilized for the design. Materials may come from roadway excavation or borrow. New construction projects should also include the embankment quantities required for guardrail and barrier treatments over and above the embankment required for the designed roadway prism.

**Pipe Backfill And Trench Backfill:** (Standard Specifications Section 501-3.04) - Pipe backfill and trench backfill material is normally obtained from excavation or from a source selected by the contractor. Unless otherwise determined in the Materials Design Report, excavated material on the project is considered suitable for pipe backfill and trench backfill. On-site material used as a source for pipe backfill and trench backfill shall meet all gradation, plastic index, pH and resistivity requirements noted in the Standard Specifications. The quantity of pipe backfill and trench backfill is calculated and shown on the Pipe Culvert Summary sheet. It is understood the quantity is for informational purposes only and is not meant to represent the actual quantity necessary to complete the work. Pipe backfill and trench backfill quantities for culverts shall be based, as applicable, on Non-Trench Condition or Trench Condition as shown in the Construction Standard Drawings. Culverts in fill are based on Non-Trench Condition and culverts in cuts are based on Trench Condition. Backfill quantities on storm drain pipe are based on the Trench Condition. The Construction Standard Drawings offer three alternate details for trench backfill placement; for the purposes of calculating quantities, the Trench Backfill With Bracing should be used except that when the designer determines that Cast-In-Place pipe is the likely choice to be made by the contractor (e.g. large diameter trunk line), the Cast-In-Place option may be used. Pipe backfill and trench backfill quantities are to be included in calculations for Culvert Quantity Adjustments. There is no separate measurement or payment for pipe backfill or trench backfill.

/Highways/Roadway\_Engineering/Roadway\_Design/Design/Aids/PDF/PPRESGUIDE2011.pdf

**Bedding:** (Standard Specifications Section 501-3.02) Culvert bedding material shall be from a source selected by the contractor. For the purpose of earthwork calculations, it is assumed that the material for bedding will come from a source outside the project. Material used as a source for bedding shall meet all requirements in the Standard Specifications. The quantity of bedding is calculated and included in Culvert Quantity Adjustments. **The quantity of bedding is not shown on the Pipe Culvert Summary sheets.** Bedding quantity shall be based on details as shown in the Construction Standard Drawings. There is no separate measurement or payment for bedding material.

**\*Structure Backfill:** (Standard Specifications Section 203-5.03) Structure backfill material is normally obtained from project excavation or from a source selected by the contractor. Unless otherwise determined in the Materials Design Report, excavated material on the project is considered suitable for structure backfill. Material used as a source for structure backfill shall meet the requirements in the Standard Specifications. The quantity of structure backfill will be calculated and shown on the appropriate plan summary sheet. Structure backfill quantity is based on details in the plans or Construction Standard Drawings. Structure backfill quantity is included in Culvert Quantity Adjustments. Structure backfill is a pay item and may be included in a lump sum pay item with the structure in accordance with the Special Provisions. If structure backfill is included in the plan details for MSE Walls, there is no separate pay item; structure backfill is included in the square-foot bid price for the MSE wall (see below).

**MSE Wall Backfill:** Backfill materials for MSE walls normally consist of reinforced backfill and retained backfill. The limits of the MSE backfill materials are shown in the project plans as details. Reinforced backfill is the material placed at the back of the MSE wall and includes the volume of material that envelopes the wall reinforcing tendons or straps. Retained backfill is the material extending beyond the reinforced backfill for a specified distance. There are special material requirements including compaction, gradation, electrochemical, friction angle and other material properties for each of these backfill types. In coordination with the geotechnical designer, the roadway designer must make a determination of whether the reinforced backfill and retained backfill materials are to be obtained from project excavation or from an offsite source (see the discussion in [Section 707.9](#) on MSE Retaining Walls). MSE backfill materials, including structure backfill, are not a separate pay item and are included in the square-foot bid price for MSE retaining wall.

**Culvert Quantity Adjustment (Pipe Culvert and Box Culvert):** There are two parts involved in the culvert quantity adjustment. The first is an adjustment to the roadway embankment calculations. This adjustment will prevent a double measurement of the area of the culvert, including backfill, above natural ground and roadway embankment quantities. The net volume, representing an embankment void, for the combined area of culvert and backfill quantities above natural ground must be calculated and used to adjust (reduce) the embankment quantity derived from the station-to-station end area calculations. The second part of the culvert quantity adjustment is in the proper accounting of all quantities involved in the installation of a culvert. On-site material is assumed to be suitable for use as a source for backfill. The proper accounting of all culvert-associated quantities is critical in determining accurate quantities for borrow or waste. Shrink and swell factors are not applied to adjust quantities in the culvert earthwork computation tables. The shrink and swell factors are applied to the culvert quantities in the development of the Earthwork Summary Table to be placed in the plans. See culvert earthwork computation examples in Appendix B.

**Existing Roadway Pavement Structure:** A determination of treatment of existing pavement structures must be made and is dependant upon whether the existing roadway or segments of the existing roadway will be disturbed by new construction.

When an existing roadway or segments of an existing roadway are undisturbed by new construction and will no longer be left in service, the existing pavement surface is normally removed and the existing subgrade is regraded to a natural condition and seeded. This work is normally constructed and paid for under items separate from earthwork quantities and is not included in the Earthwork Summary.

When an existing roadway falls within the slope limits of the new roadway, the existing pavement section is treated according to the determination made by the designer in coordination with Materials Design. If the existing roadway surface is part of a roadway excavation area, most times it may be utilized in the lower layers of an embankment and is included in the roadway excavation quantities. This is common for most AC pavements but needs evaluation in the case of PCC pavements. If the pavement is to be hauled off the project and is not utilized, it is paid for as pavement removal and the quantity is excluded from roadway excavation.

When a new embankment is constructed over an existing pavement, the pavement may be removed in some cases but most often is left in place. When left in place, bituminous surfaces are normally scarified prior to embankment placement. Concrete pavements that are left in place are often broken up or cracked and seated prior to placement of the new embankment. Materials Design will determine the treatment for existing pavements that are left in place. When surfacing materials are to be removed prior to placement of embankment, the volume occupied by the surfacing materials must be included in the embankment quantity required.

Environmental requirements must be reviewed and complied with when excavating and disposing of existing pavement materials.

**Slope Rounding:** Slope rounding is applied at the intersection of the roadway cut slope (except in solid rock) with existing ground surface as shown on the Standard C-2 Series. Quantities are not adjusted for rounding; calculations are based upon a straight line intersection. There is no separate payment for slope rounding.

**Balanced Earthwork Project:** Is defined in this document as a project wherein all earthwork quantities, net excavation and net embankment, within the project limits are nearly balanced or equal. A balanced earthwork project is highly desirable. The designer's goal is to produce a design that has a close material balance within the project limits. A project with five to ten percent waste is considered to be in balance and is desired. Projects should be designed with sufficient excess material (waste) to avoid creating a condition requiring a change order due to deviations in shrink and swell factors during construction. Projects with small amounts of excavation are normally designed with a ten percent waste and projects with large amounts of excavation and various shrink and swell factors with five percent waste. The percent of waste noted above are initial estimates and should be coordinated with District, Materials Group and Roadway Design Section personnel in determining the appropriate waste amount. It is not always practical to achieve balanced earthwork projects with corridor studies, however, balancing earthwork between adjacent or nearby projects is encouraged to minimize borrow or waste on

each project. Material that is to be hauled to other projects or stockpiled for use on other projects is identified as haul out on the original project. The haul out target site is to be identified in a detail on the original project. On the subsequent project, the haul in material is identified in a detail and utilized as roadway excavation for the project.

**Balanced Earthwork Quantities:** Is defined in this document as a process wherein all earthwork quantities shown on the Earthwork Summary Table in the plans will balance or equal. All types of excavation, including borrow and haul in, must balance or equal all types of embankments, including waste and haul out. See [Figure 709.1](#).

## **702 - Existing Ground Data**

### **702.1 - Cross Sections**

All earthwork quantities measured by the cubic yard shall be computed using cross sections taken at each station. Additional sections are required at breaks in the surface to insure an accurate calculation of the earthwork volume. See [Figure 702.1](#). This requirement shall apply to any design element that has horizontal and vertical control shown on the project plans when the volume is minor, cross sections may or may not be required. Normally, this only applies to turnouts, driveways, berms, dikes and minor drainage channels. The cross sections to be used in calculating the earthwork volume may be developed by conventional field surveys or photogrammetric surveys. With both methods, it is important that sufficient sections be used to accurately compute the earthwork quantities.

### **702.2 - Field Surveyed Cross Sections**

Cross section data for design and earthwork calculations shall be taken at each station on tangents and additional locations on curves, as a minimum, with additional sections taken as required at breaks in the terrain surface to insure that a complete description of the existing ground is obtained (See [Figure 702.1](#)). The width of the cross sections must extend a sufficient distance on each side of centerline to include the entire cut or fill slopes of the proposed roadway cross section, and the right of way.

The equipment and methods used to pick up the cross section data will vary according to the type of terrain and the precision required of the equipment used to collect the data. When cross-sectioning urban areas, elevations of curbs, gutters, etc. shall be recorded to the nearest 0.01 ft. When cross-sectioning areas where 'total stations' data collectors, and computer processing equipment are being used for design and to calculate quantities, make sure that the correct computer format is being used while collecting the field survey data.

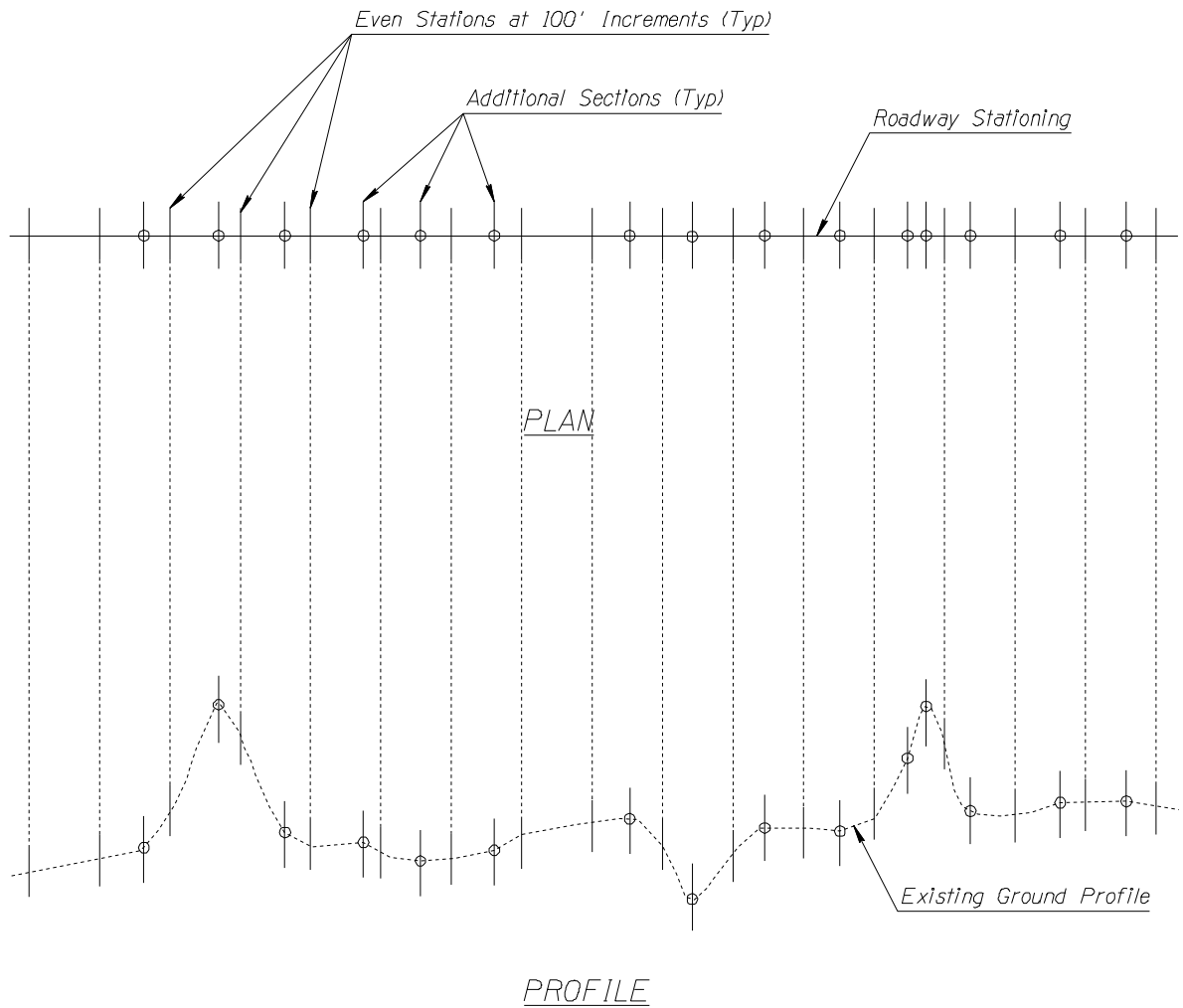

**LEGEND**

- ⊕ Required Additional Section Locations  
(As determined by Design Engineer)
- ⊕ Even Station Section Locations  
(100' Typical)

NOTE: Cross sections are required at existing ground breaks.  
Design Engineer to direct surveying and mapping to  
produce proper groundline information.

**ADDITIONAL CROSS SECTION LOCATIONS  
FIGURE 702.1**

### **702.3 - Digital Terrain Modeling**

For a DTM model, the data is collected by using photogrammetry or a total station in conjunction with an electronic data collector. The data is stored as individual points (random or mass points, or spot heights), or a series of connected points in a stringline when in the line/arc mode. This data is then used to build a mathematical model of the ground surface. With the appropriate hardware and software, "Digital Terrain Modeling" has a variety of uses: 3-D design, contour interpolation and generation, automatic cross section and profile generation, and earthwork computation.

All coded data is collected with X, Y & Z coordinate values relating to the specific coordinate system being used, and stored in the data collector as either topographic points, or points on a stringline.

Unlike a conventional survey where cross sections are taken at right angles to the centerline of the roadway or a given alignment, the DTM survey collects the X, Y, Z data at the perimeter of an irregularly shaped plane.

A good example of this is the face of an existing cut section along a tangent section of a roadway. The face is inclined at the same angle from the toe to the hinge point of the cut. Properly spaced rod shots, defining all breaks, taken along the perimeter of the cut tracing the hinge point and the toe of the cut would correctly define the shape of the plane.

All raw data must be processed to create a 3D faceted surface that defines the Digital Terrain Model (DTM). This will allow CADD operators to generate triangles that can be interpolated between points with respect to their coordinates, and contour lines can then be generated using these triangles. From the data base existing groundline cross sections are then generated for use in Earthwork computations.

### **702.4 - Photogrammetry**

Photogrammetry can be defined as the science and art of determining qualitative and quantitative characteristics of objects from the images recorded on photographic emulsions.

Objects are identified and qualitatively described by observing photographic image characteristics such as shape, pattern, tone, and texture. Identification of deciduous versus coniferous trees, delineation of geologic landforms, and inventories of existing land use are examples of qualitative observations obtained from photography.

The quantitative characteristics of objects such as size, orientation, and position are determined from measured image positions in the image plane of the camera taking the photography. Tree heights, earthwork volumes, topographic maps, and horizontal and vertical coordinates of unknown points are examples of quantitative measurements obtained from photography.

Photogrammetric mapping procedures are used to determine the project elements that need to be addressed when planning, specifying and estimating costs for a digital mapping project.

**702.5 - Phased Construction Groundline**

When construction activity requires phasing of the earthwork, the finished subgrade and slope surfaces of each construction phase becomes the “groundline” of the next phase. See [Figure 702.5](#) for an example of phased construction groundlines.

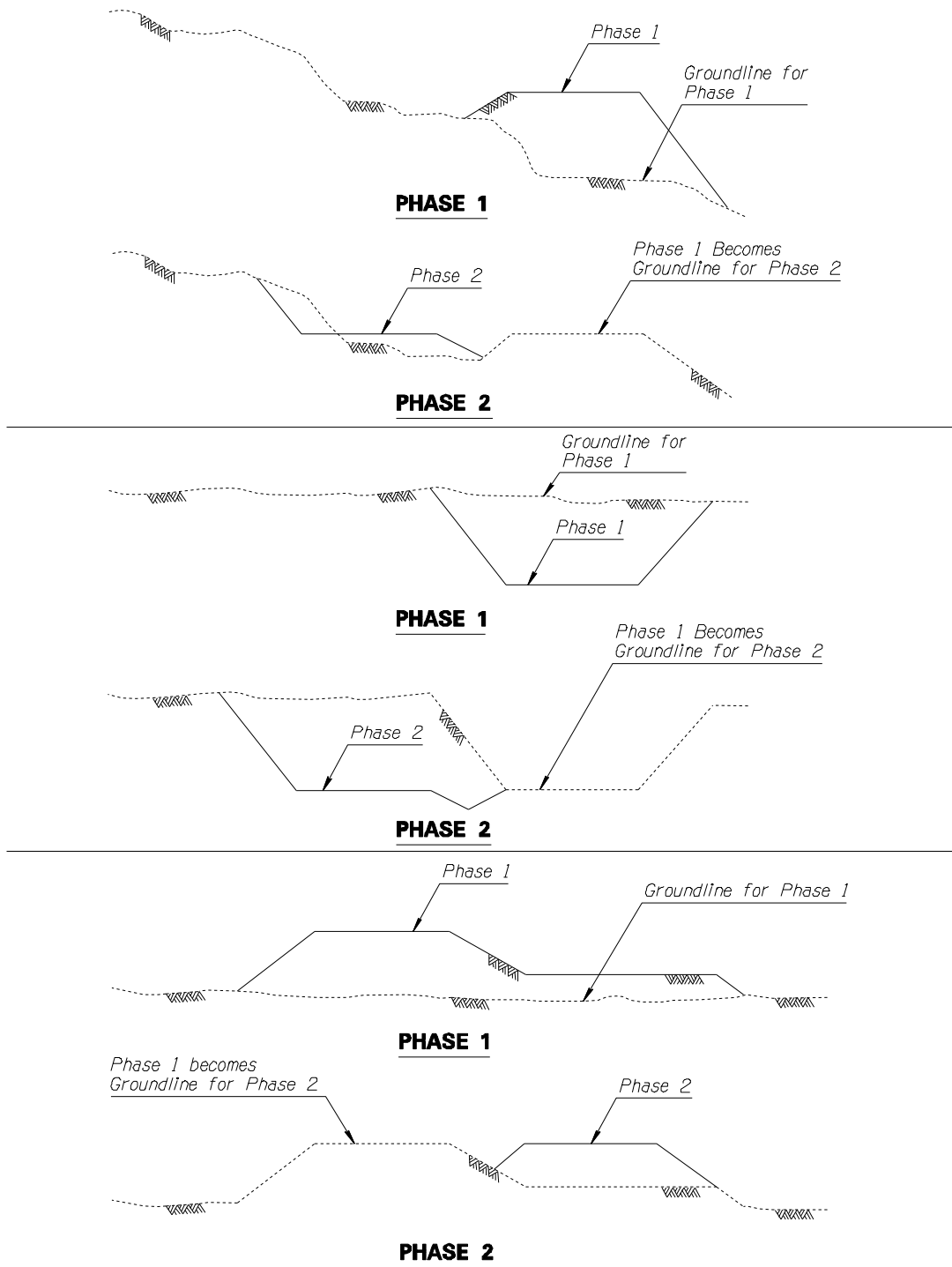

**PHASED CONSTRUCTION GROUND LINES  
FIGURE 702.5**

---

## **703 - Templates**

### **703.1 - General**

For earthwork computational purposes, the template is defined as that portion of the roadway, dike or drainage channel which is controlled by a profile grade and horizontal alignment.

The earthwork template defines the subgrade surface the earthwork volumes are being computed to. The template is computed from information provided by the typical sections of the construction plans. Additional dimensions may be needed for proper description of the earthwork template. Additional details could include slope rounding (slope rounding is entered as tangents instead of curved surfaces. See [Figure 703.4C](#)), median treatment and details that describe the sub-grade below the roadway surfacing, slope paving, curb and gutter, and sidewalks. In all cases the template segments are connected to and controlled by the profile grade and the horizontal alignment.

The template segments are always defined by horizontal distances and slopes, as shown in [Figure 703.1](#). The roadway width and shoulder wedge remains constant in tangent and in superelevated sections as shown on [Figure 703.1](#).

### **703.2 - Urban Highways**

An example of urban roadway template points and segments are shown in [Figure 703.2](#). (Note the detailed description of the curb and gutter.)

### **703.3 - Rural Highways**

An example of a rural roadway template's points and segments are shown in [Figure 703.3](#).

### **703.4 - Special Conditions**

Various examples of typical roadway sections and their template segments are shown in [Figures 703.4A](#), [703.4B](#) and [703.4C](#). Note in [703.4C](#) the approximation of the slope rounding, by the 10' at 20:1 segment. Slope rounding is not included in the calculations for the earthwork quantities. Calculations are based upon the straight-line segments through the P.I. Slope rounding shows on the roadway typical sections but will not show on the roadway cross-sections.

### **703.5 - Plating**

In urban areas, the roadway side slopes and median slopes may be plated with topsoil to accommodate landscaping. See [Figure 703.5](#) for typical plating details.

### **703.6 - Topsoil Excavation**

The topsoil removal depth is defined in the Materials Design Report. The removal of the topsoil is treated as a separate excavation quantity. Topsoil is normally obtained from excavation areas within the project limits. It is in addition to any other quantified excavation. When topsoil is obtained from a fill section, the additional embankment volume (created by the topsoil removal) must be accounted for. See [Figure 703.5](#) for Plating and Topsoil Excavation.

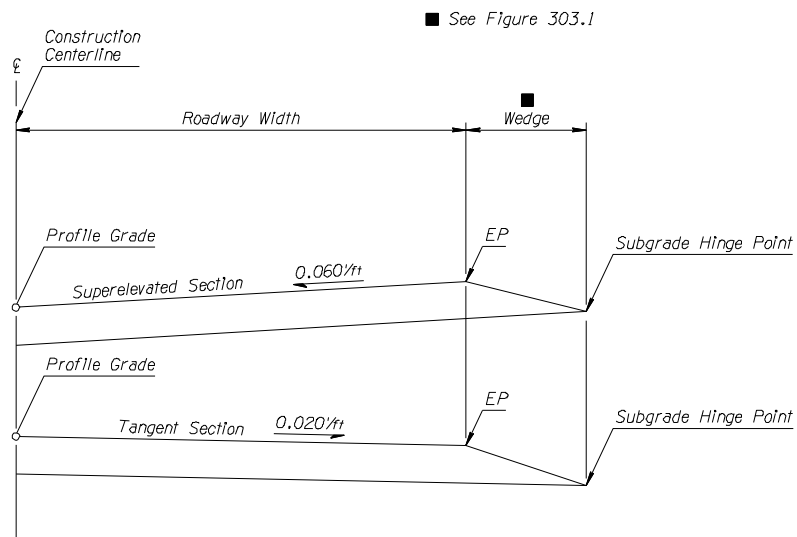

**TEMPLATE WIDTHS THROUGH  
SUPERELEVATED SECTIONS  
FIGURE 703.1**

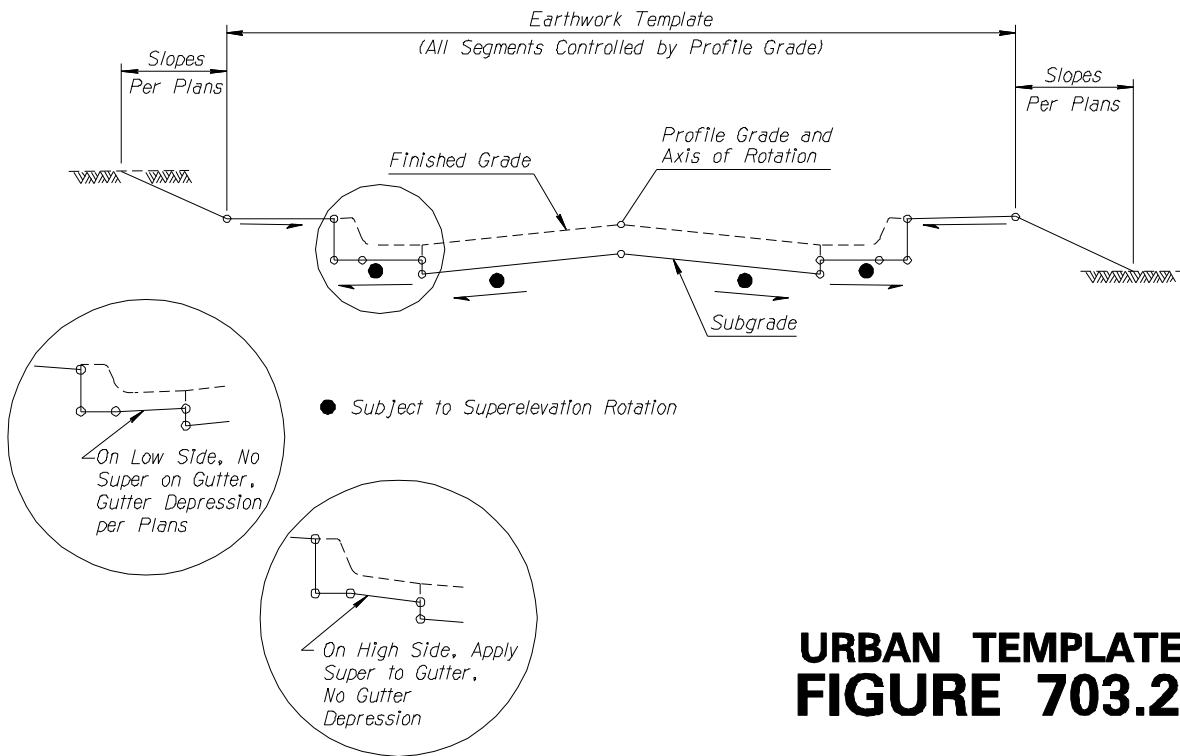

**URBAN TEMPLATE  
FIGURE 703.2**

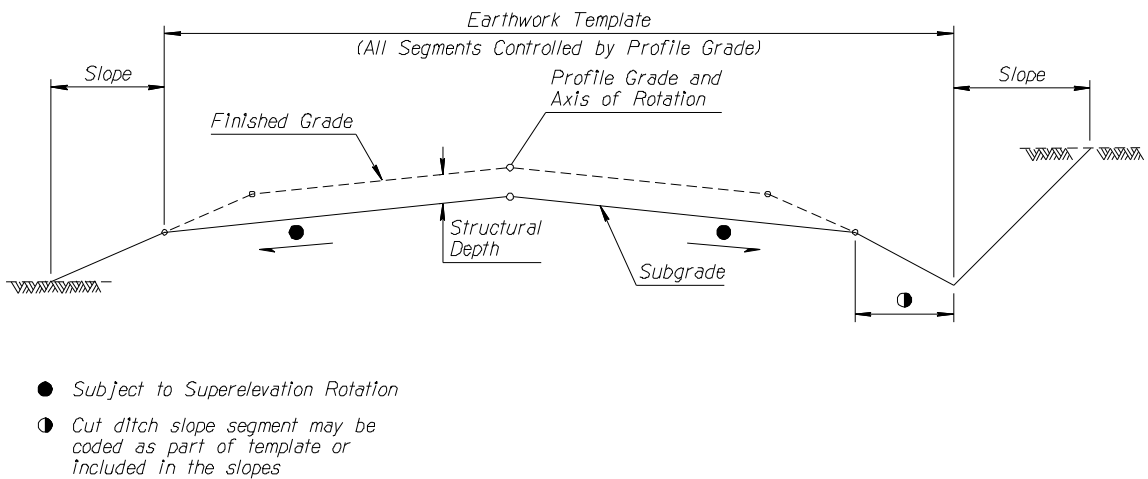

**RURAL TEMPLATE  
FIGURE 703.3**

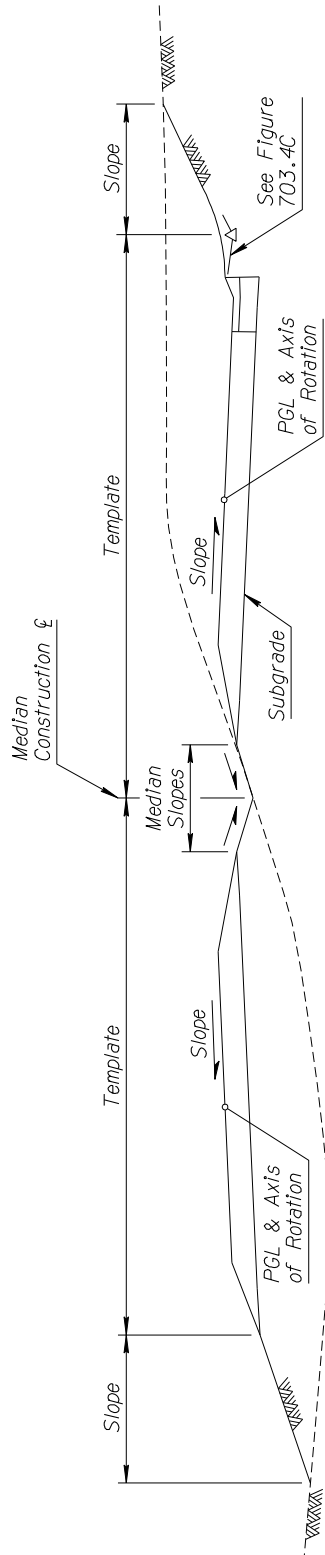

TANGENT ROADWAY SECTION

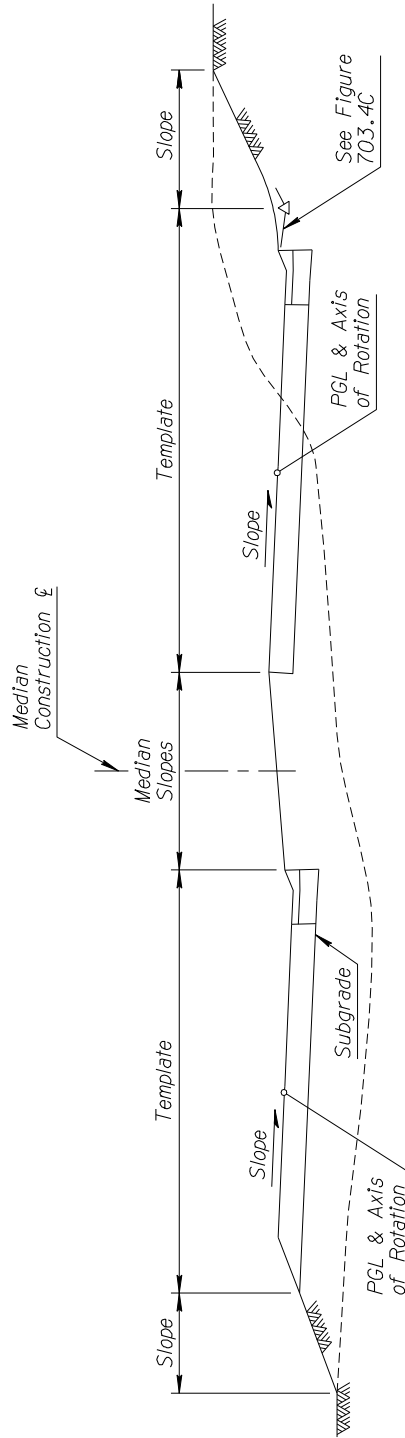

SUPERELEVATED ROADWAY SECTION

**TANGENT ROADWAY & SUPERELEVATED ROADWAY TEMPLATES  
FIGURE 703.4A**

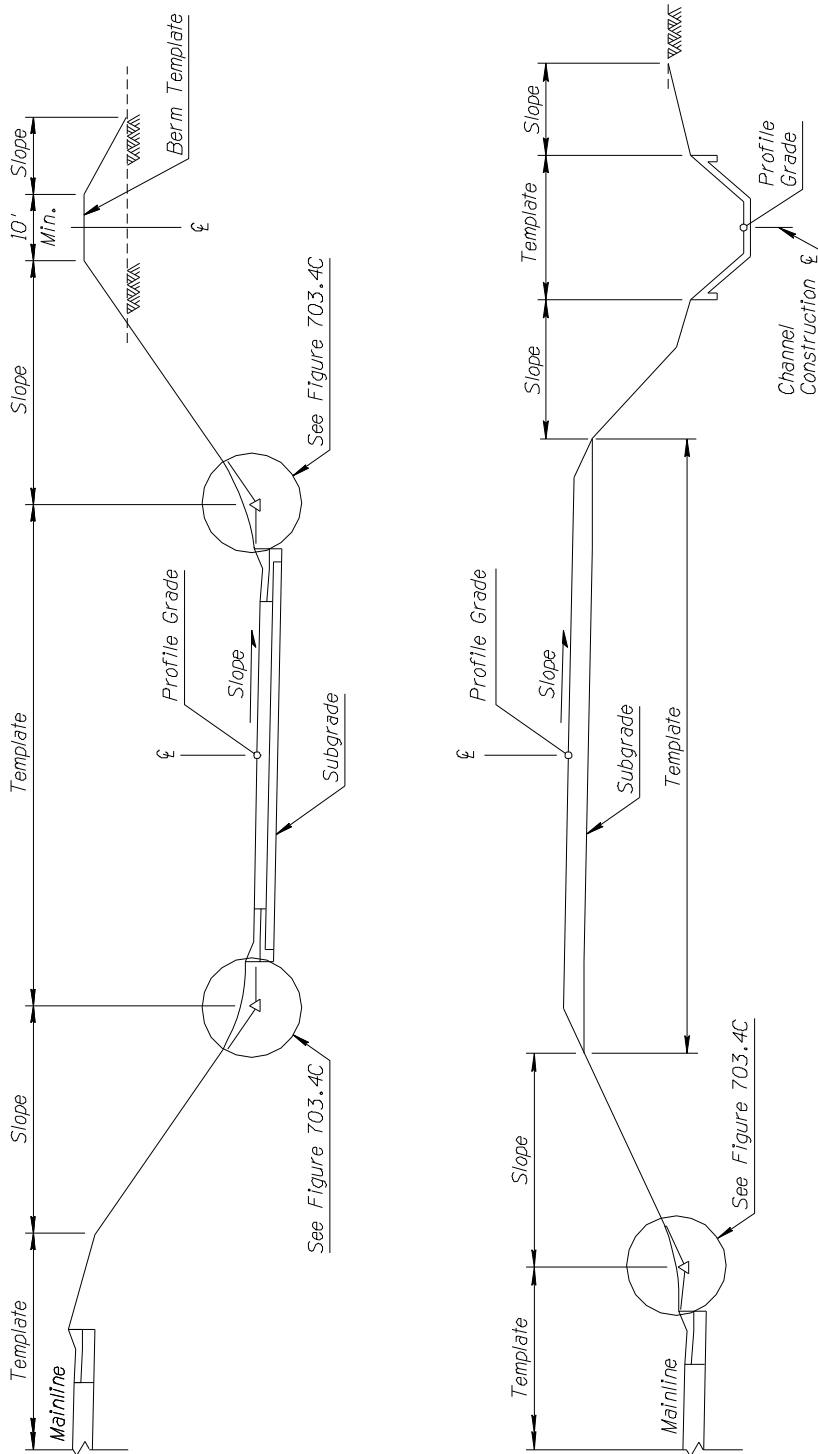

**RAMP TEMPLATES  
FIGURE 703.4B**

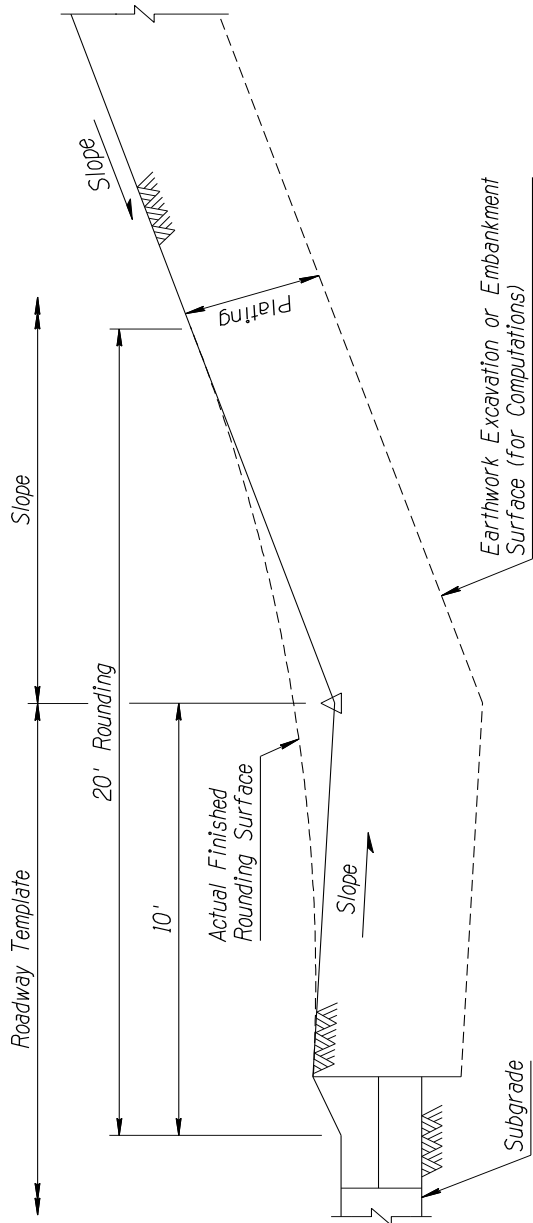

**ROUNDING**  
**FIGURE 703.4C**

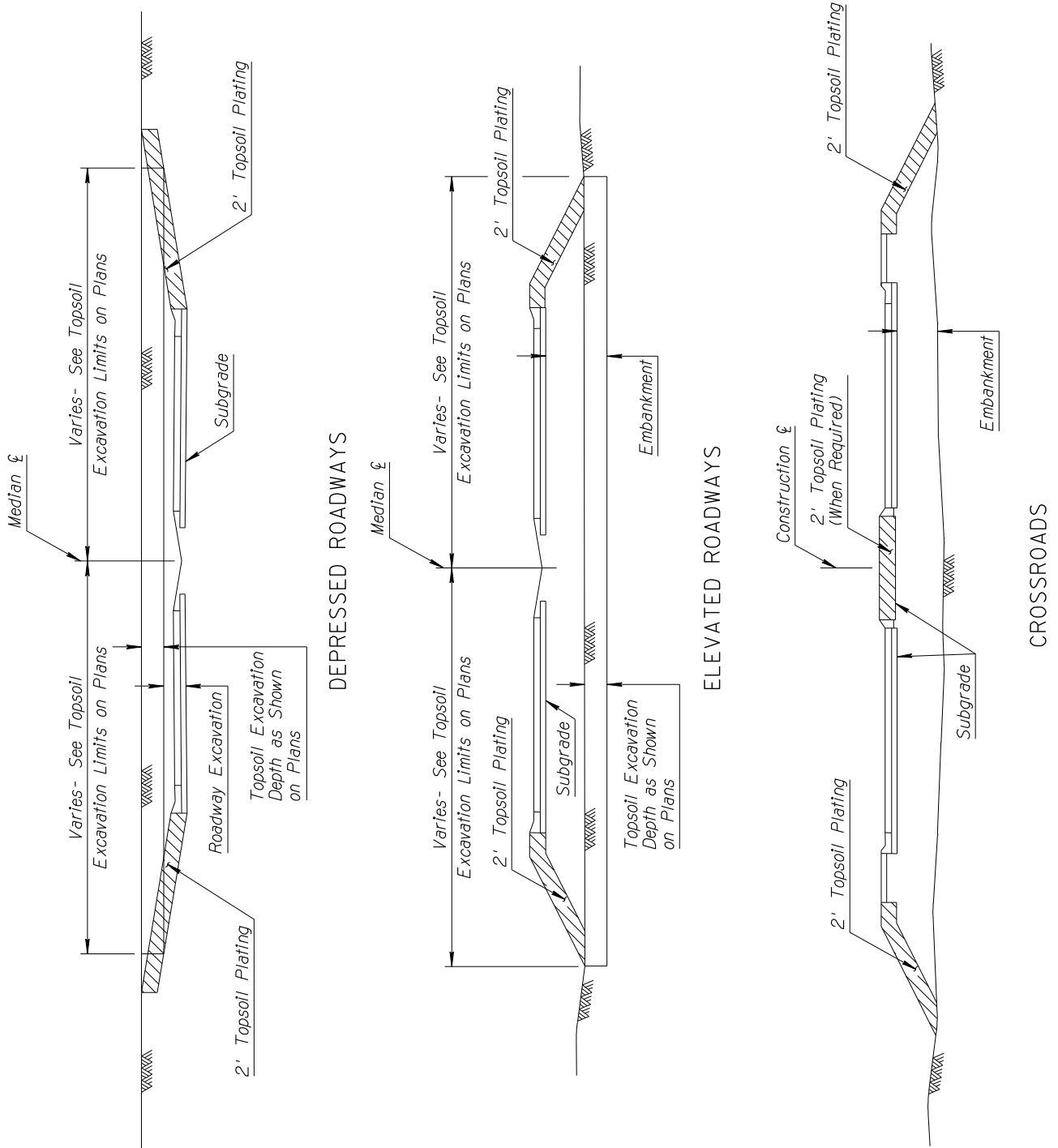

**PLATING AND TOPSOIL EXCAVATION  
(URBAN FREEWAY)  
FIGURE 703.5**

---

## **704 - Slopes**

### **704.1 – General**

Slopes are applied to the templates, and they fall into two categories; Standard and Non-Standard. Standard slopes are based on the design criteria and can be obtained from the typical section sheets of the plans. The slopes are further described in Roadway Construction Standards C-02 series and [Section 303](#). The slope treatment, maximum heights, and the exact relationship between slopes, heights and horizontal distances are described in the Construction Standards, and are to be duplicated/described the same way with the earthwork computer program. Non-standard slopes are detailed in the plans.

### **704.2 - Materials Design Report**

The Materials Design Report provides the project and location specific slope information for the designer. The information provided is a maximum boundary condition, to maintain slope stability. Benching, rock cut slopes and other data may be of significant importance to the designer, and provides guidelines that will have to be observed during earthwork computations.

### **704.3 - Cut Slopes**

Extra care must be taken at transition segments of cut-to-fill, and at fill-to-cut sections. In shallow fills, and shallow cuts, the application of standard cut ditches are usually problematic for most computer programs. It is not an automatic process, and the Engineer must review the cross-section plots in these transition areas, for proper description of cut ditches, and proper handling of the shallow fills. See these critical areas on [Figure 704.3A](#) (Note; undesirable slope intercept points between the shoulder wedge and back slope.) The shallow fill condition requires the application of a cut ditch, with a minimum depth of 1 ft between the subgrade Shoulder Point, and the natural ground, or the cut ditch bottom.

Another difficult condition is the “sliver cut”. “Sliver cuts” are narrow widths of excavation encountered when ditches and cut slopes are widened. The narrowness makes the excavation nonconstructable with standard equipment and should be avoided whenever possible. See [Figure 704.3B](#) for example.

### **704.4 - Fill Slopes**

Fill Slopes are usually less problematic than the cut slopes for earthwork computations. The special conditions to be considered are shallow fills and sliver fill areas that can be avoided by careful examination of the cross section plots. Controlling of fill slopes during phased construction can be a major problem for the designer. The earthwork computation must exactly duplicate the roadway slopes during each phase, in order to account for the required fill material for constructing each phase. Consider the need for benching for shallow sliver fills. See Structural Specifications Section 203-10.03 and consult with a Geotechnical Specialist. (Also, see U.S. National Forest Design Guidelines)

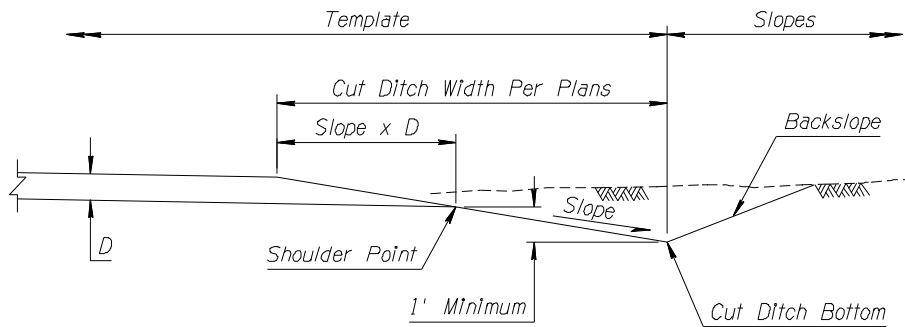

**▲ SHALLOW CUT CONDITION**

- ▲ *In extremely shallow cut or fill conditions, the cut ditch may be eliminated if the proposed ditch bottom elevation is lower than existing groundline and the ditch will not drain properly. Additionally the existing groundline must drain (slope) away from the roadway.*

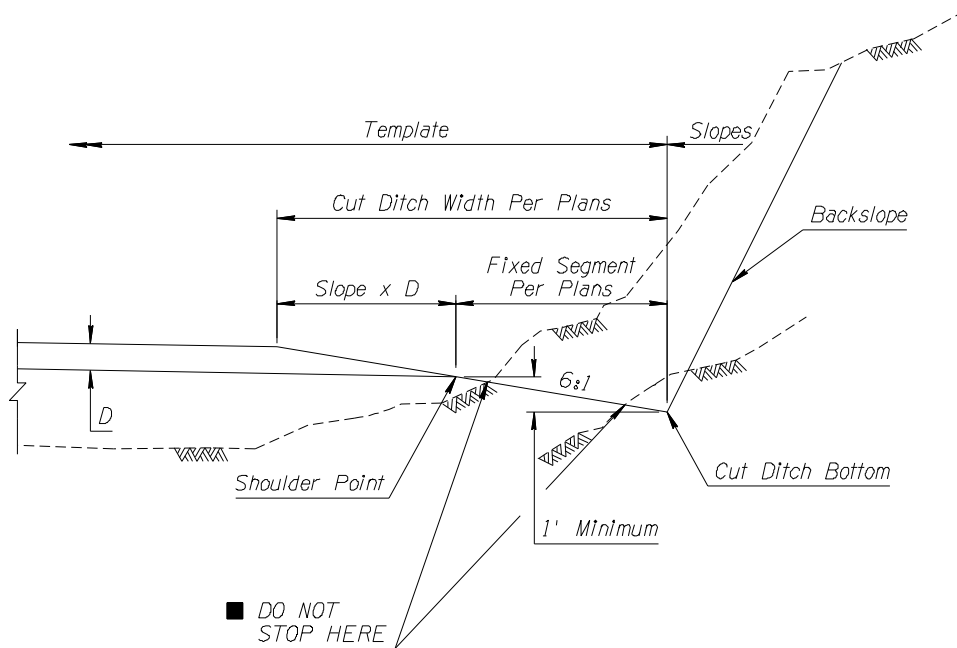

**SHALLOW FILL CONDITION**

- *Except at crest locations where continuous drainage flow is not required and appropriate horizontal sight distance is provided.*

**FILL-TO-CUT SHOULDER TRANSITIONS  
FIGURE 704.3A**

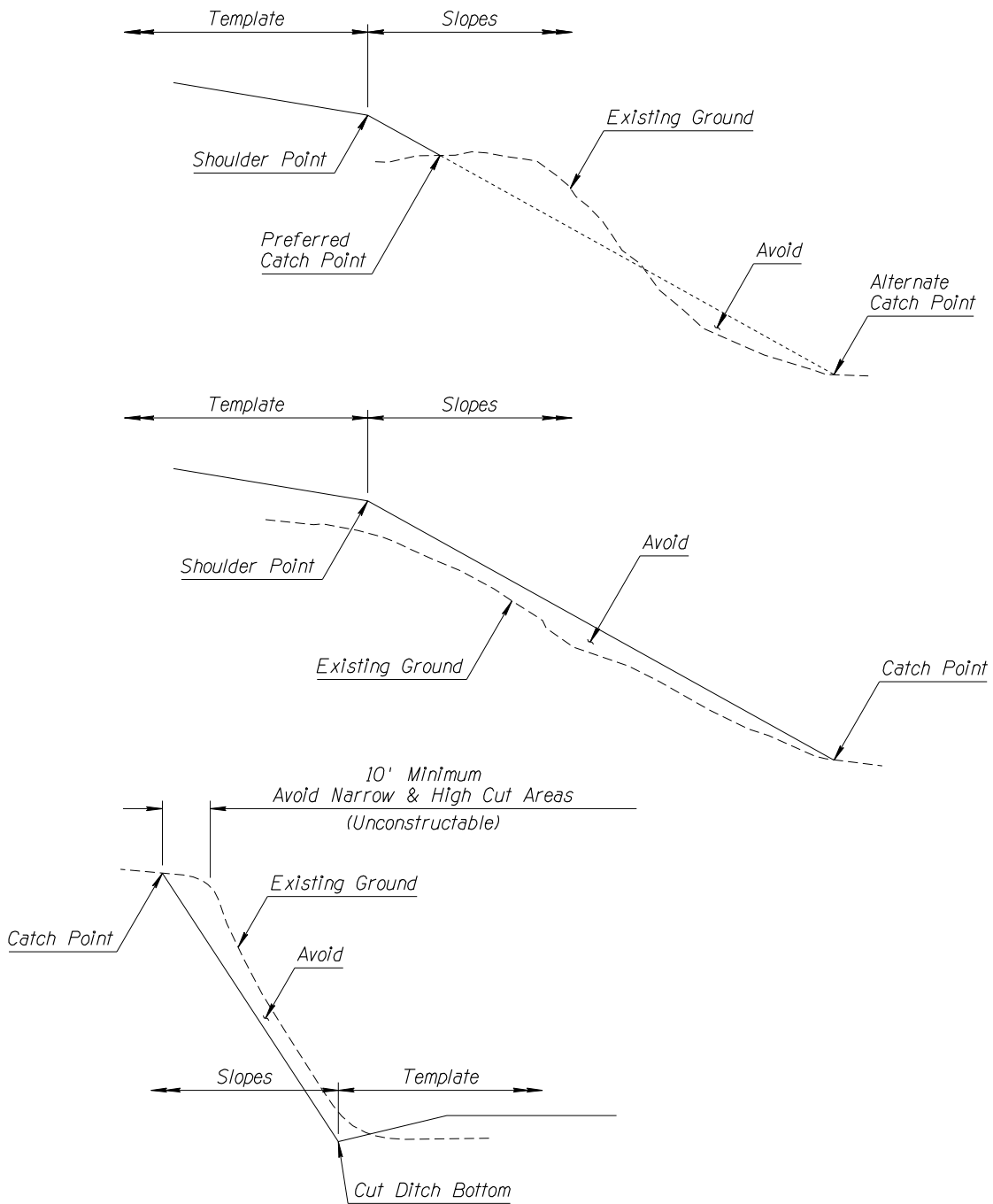

**SLIVER CUTS AND FILLS  
FIGURE 704.3B**

### **704.5 - Contour Grading**

Contour Grading is applied in [Figure 703.5 - Urban Areas](#), where landscaping is accommodated by irregular shaping of areas, usually between ramps, main roadways and structures in interchanges. The separation of quantities for each road requires the creation of lines of separation/match lines of earthwork. See [Figure 704.5](#).

## **705 - Drainage Related Earthwork**

### **705.1- General**

Drainage excavation shall consist of the excavation of ditches, channels, waterways and erosion control features, except for parallel roadway cut ditches that are considered part of the roadway prism and are calculated as roadway excavation.

### **705.2 - Channels and Dikes**

Channels and Dikes are independently controlled by horizontal and vertical alignment, and computed in a similar manner as roadways. Concrete lining, riprap lining, and erosion control structures have to be accounted for in determining the earthwork quantities.

### **705.3 - Pipe Backfill, Trench Backfill and Bedding**

Backfill and bedding material requirements for all drainage features including pipe culverts and storm drains should be analyzed and included in the earthwork quantities summarized in the final Earthwork Summary Table. See explanation in [Section 701.4 - Definitions/Concepts](#). See [Figure 705.3](#).

### **705.4 - Structure Backfill**

Backfill material requirements for box culverts, retaining/sound walls and abutments should be analyzed and included in the earthwork quantities summarized in the final Earthwork Summary Table. See discussion in [Section 701.4](#) and [707.9](#). See [Figure 705.4](#).

### **705.5 - Pipe Excavation and Structural Excavation**

Excavation material requirements for pipe culverts, storm drains, box culvert, retaining/sound walls and abutments should be analyzed and included in the earthwork quantities summarized in the final Earthwork Summary Table. See explanation in [Section 701.4 - Definitions/Concepts](#). See [Figures 705.3](#) and [705.5](#).



- GENERAL NOTES**
1. Pipes shall be installed either in a trench in natural ground or in embankment.
  2. In a trench condition, the vertical and horizontal limits shall be maintained. If horizontal limits are exceeded or the vertical condition exists.
  3. Bracing and sloping shall conform to OSHA requirements.
  4. Pipe backfill may be bedding material.
  5. In a non-trench condition, the embankment for pipe stability shall be constructed in lifts with the bedding material and pipe backfill. The contractor chooses to construct it as a trench condition, the embankment shall be constructed before excavating the trench.
- D - Outside diameter of full circle pipe or arch pipe, elliptical pipe,  
 T - Minimum wall thickness for NRCIPCP; See Plans.  
 ① ▲ For  $D < 4$ ;  $D + 5'$  each side, minimum  
 ① ○ For  $D \geq 4$ ;  $D + 1'$  each side, minimum  
 ● - 6 inches except when on unyielding or unstable material. See Std Specs.

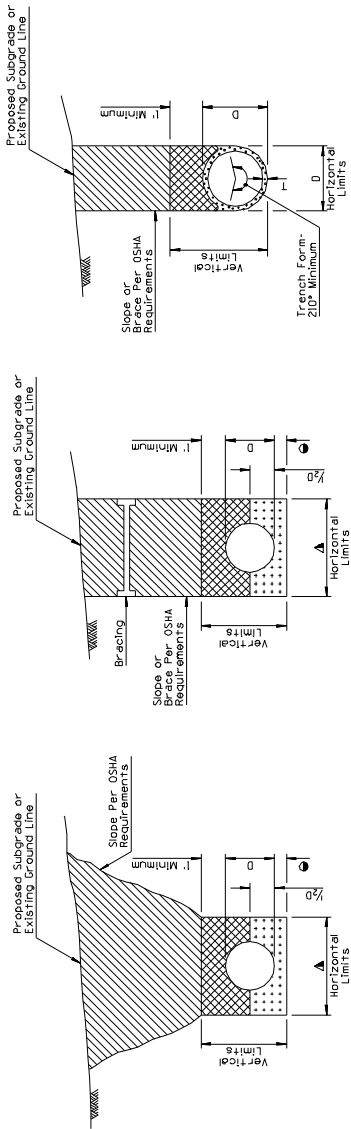

TRENCH CONDITION  
 IN NATURAL GROUND OR IN EMBANKMENT  
 WITH BRACING SHOWN

TRENCH CONDITION  
 IN NATURAL GROUND OR IN EMBANKMENT  
 WITHOUT BRACING

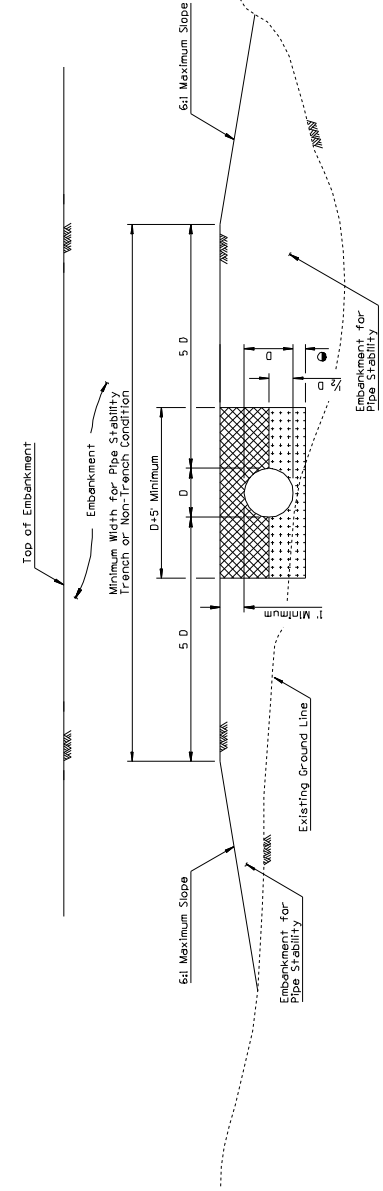
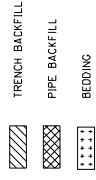

NON-TRENCH CONDITION

**STORM DRAINS AND PIPELINE EXCAVATION**  
 (ADOT STANDARD DRAWING NO. C-13.15, Rev. 9-04)  
**FIGURE 705.3**

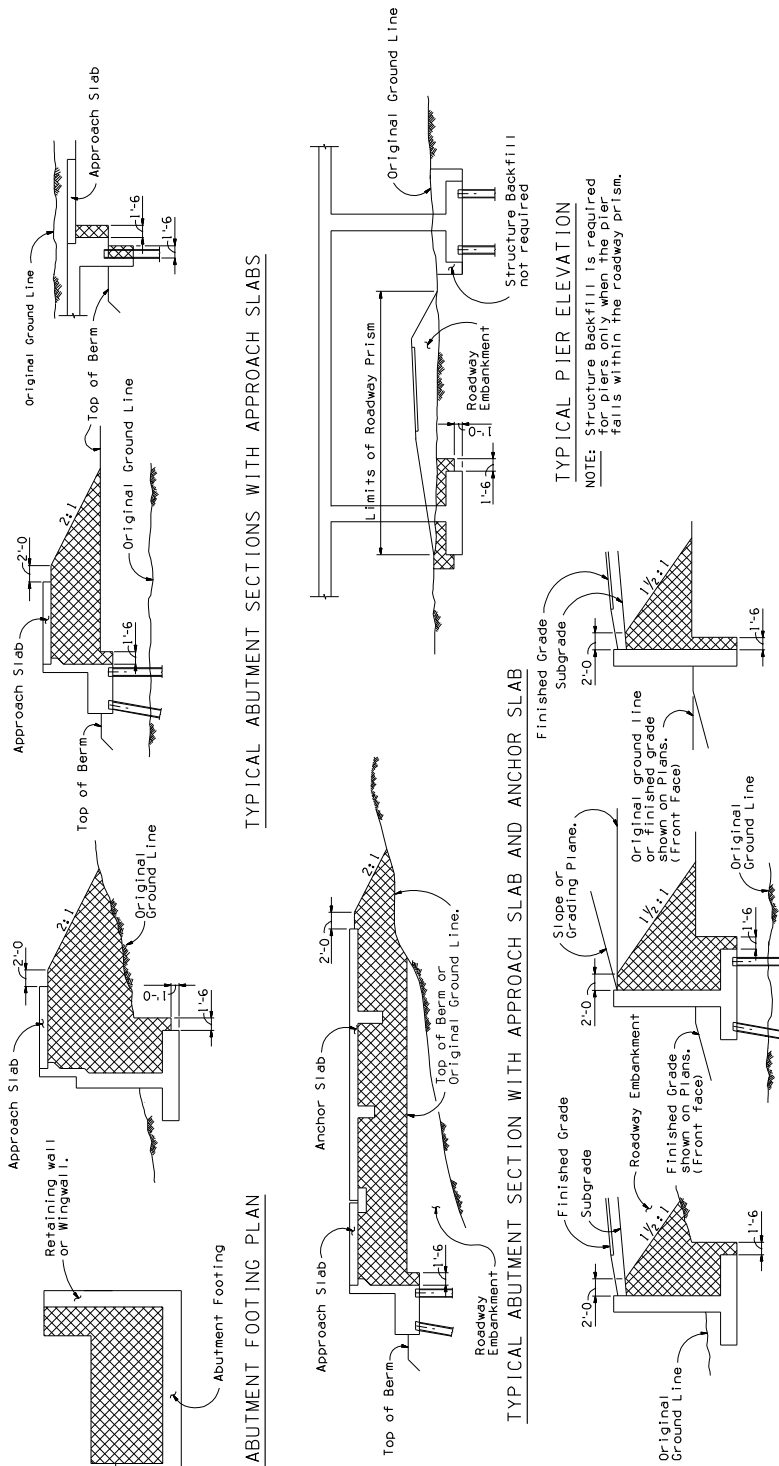

TYPICAL ABUTMENT SECTIONS WITH APPROACH SLABS

TYPICAL ABUTMENT FOOTING PLAN

TYPICAL ABUTMENT SECTION WITH APPROACH SLAB AND ANCHOR SLAB

TYPICAL PIER ELEVATION

NOTE: Structure Backfill is required for piers only when the pier falls within the roadway prism.

NOTES:

- Indicates Structural Backfill.
- Roadway Prism shall be the distance between points of intersection of Roadway Embankment and Original Ground Line.
- "Top of Berm" shall mean the top of berm or elevation at point of intersection between front face and slope.

TYPICAL WALL SECTIONS

EXAMPLE ONLY: USE BRIDGE DESIGN GUIDELINES ON ADOT BRIDGE GROUP WEBSITE

**STRUCTURE BACKFILL  
PAYMENT LIMITS  
FIGURE 705.4**

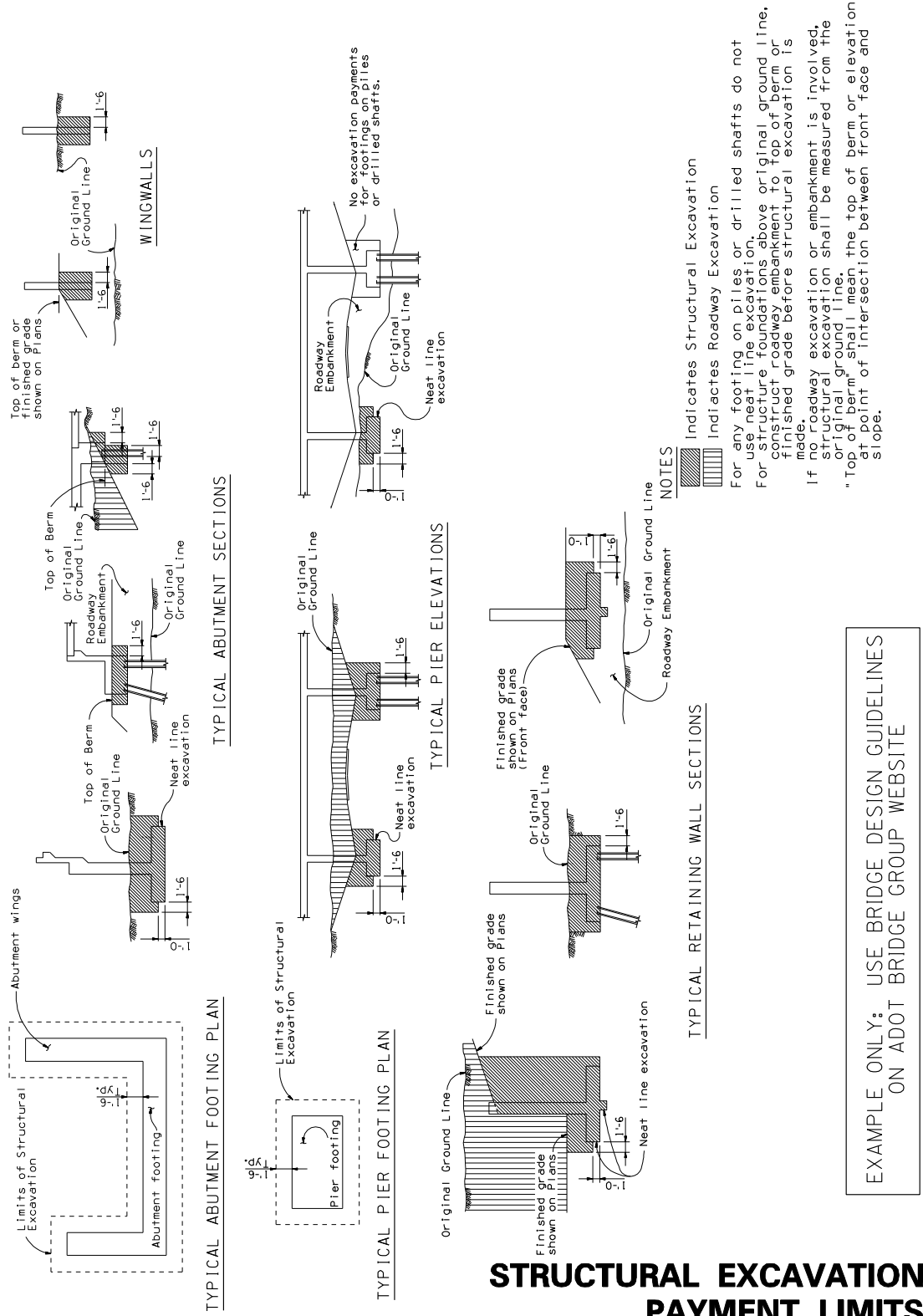

**STRUCTURAL EXCAVATION  
PAYMENT LIMITS  
FIGURE 705.5**

---

## **706 - Material Factors**

### **706.1 - Shrinkage and Swell**

Allowance must be made for the change in volume of excavated materials from the **original** volume in cut to the **final** volume in fill after **shrinkage** and settlement have taken place. As a result of being broken up into chunks of various sizes, practically all materials increase in volume when first excavated. After being placed in the embankment, most soils decrease again in volume because of the compaction methods used in placing the fill or as a result of natural settlement due to climatic conditions over a period of time. Therefore, the final volume of soils in the embankment will usually be considerably less than the original volume in the cut. This is illustrated by the fact that one may dig a hole in solid ground, and then replace the excavated material by tamping in layers and not have enough to fill the hole. The soil before excavation contains a high percentage of voids resulting from growth and decay of vegetation, and other causes. When the material is re-tamped in layers, most of these voids are eliminated, and **shrinkage** in volume is thus produced.

When excavating in rocky-type material, there is a resultant **swell** in volume owing to the fact that the solid stone is broken up into chunks and, when the broken rock is placed in the embankment, there is a high percentage of voids.

**Swell** may therefore be defined as the difference between the **original** volume in cut and the **final** volume in fill.

The percent allowed for this swell varies considerably with different soils, and obtained from the Material Design Report (in 5% increments).

Note: The Shrinkage and Swell factors are provided in the Materials Design Report for the entire length of the project, from station-to-station, usually along the survey or median centerline. In the case of multiple parallel roadways, the shrink and swell factors may vary between the adjacent roadways at identical stations due to changes of material characteristics across the section. Because of this possibility, the designer may need to investigate field conditions and request additional data from the Materials Division, to establish appropriate shrinkage and swell-factor change stationing for each alignment.

When significant horizontal and/or vertical changes take place between the DCR and the proposed design, test hole locations and their depths will have to be checked to assure appropriate material information for each alignment.

### **706.2 - Ground Compaction**

Compaction is the lowering of the ground surface. Such **compaction** of the ground varies with the type of soil. It should be noted that compaction is a vertical change, (measured in inches) which occurs when embankment is placed over ground having low supporting strength. The weight of the required embankment and the construction activity may compress or displace the underlying voids in the soil, and cause an increase in volume of the required embankment.

The amount of ground compaction increases the embankment requirement of the project, and it is computed by multiplying the compaction factor (obtained from the Materials Design Report) with the surface area under the embankment. See ground compaction description in Section 701.4 for additional considerations.

Ground Compaction Applications are shown in [Figure 701.4C](#).

## **707 – Miscellaneous Earthwork**

### **707.1- Unsuitable Materials**

Quantities of material below the natural ground surface in embankment areas and below finished subgrade elevation in excavated areas, that are unsuitable, shall be computed and their method of disposal indicated on the plans. When unsuitable material is removed and disposed of, the resulting space shall be filled with suitable material. See definition of overexcavation and collapsible soils in [Section 701.4](#).

### **707.2 Turnouts**

The turnout earthwork quantities are usually computed by plotting manual cross sections. The estimated turnout earthwork, with the proper adjustments, are added to the mainline quantities.

### **707.3 Cross Roads**

The cross road earthwork is computed in the same manner as the mainline, from groundline, template, slopes with appropriate adjustments for shrink, swell and ground compaction. It is listed separately and the computed quantities are shown on the Cross Road Plans.

### **707.4 Rest Areas**

The Rest Area earthwork quantities have to be computed and shown as separate earthwork quantities and shown on the Plans. The Rest Area Entrance and Exit Ramps are computed similarly as Interchange Ramps, and the Rest Area Parking Areas and irregular features may be computed by hand-plotted cross sections, or with differential surface modeling techniques.

### **707.5 Interchanges**

Interchange Ramp earthwork quantities are developed separately and the quantities are shown on their respective plans. If the Interchange is Contour Graded, the quantities may be computed from hand-plotted cross sections or by using computer software.

### **707.6 Bridges**

Earthwork at bridge locations is considered as a gap in the mainline earthwork from ends of the abutments. The abutment cone material requirements are included in the mainline quantity calculations by tapering to zero at a distance representing the approximate cone volume. Drainage

excavation and/or channel excavation are included in their respective items. Structure excavation and structure backfill are in accordance with Bridge Drawings. Material that is excavated for drilled shafts is utilized for embankment material when deemed suitable in the geotechnical report.

### **707.7- Detours**

Detours are temporary roadways used to bypass work areas or to connect roadways during phased construction. Quantities may be calculated by hand or by computer methods. The earthwork quantities are included in the earthwork summary with appropriate shrink and ground compaction applied. Detours are removed after completion of their use. Excavation quantities from detour removal may be included in the quantity summary when there is a significant quantity and it can be utilized for project embankment. When the quantity of material is small and no usage is anticipated, removal of the detour may be specified with no separate payment. If the detour pavement is to be removed separately and not utilized in an embankment, the pavement removal is paid for under a separate item. Detours having a very low profile grade may have the pavement removed and the remaining roadway reshaped and regraded and left in place using a separate pay item.

### **707.8 - Roadway Connections**

Roadway Connections are similar to detours but are longer-term temporary roadways connecting a newly constructed roadway with an existing roadway. Roadway connections are normally located at the termini of a project and are left in place at the completion of a project. An example is where a newly divided highway section is completed and connected to the existing undivided highway and the connection remains in place until a new project is undertaken to reconstruct the undivided highway to a divided highway. Earthwork is treated as described under Detours.

### **707.9 - Mechanically Stabilized Earth (MSE) Retaining Walls**

MSE wall excavation, all backfill materials and embankment adjustments associated with mechanically stabilized earth (MSE) retaining walls are to be included in the earthwork calculations. Since there are special material requirements for reinforced backfill and retained backfill, the backfill materials may not be readily obtained from project excavation materials. It is critical for tests of the onsite materials to be done early in the planning process to determine if onsite materials are suitable as the source for all types of backfill materials; see [Section 311](#).

If a geotechnical investigation determines that any MSE wall backfill materials are available from project excavation, those quantities would be included on the earthwork summary table on the plans. See Quantity Summary Table Examples No. 3A – Waste Project with Onsite Source for MSE Wall Backfill Materials and No. 3B – Waste Project with Offsite Source for MSE Wall Backfill Materials in Appendix B.

Should the geotechnical determination indicate that the onsite materials are unsuitable for any MSE wall backfill materials, all backfill quantities are to come from offsite sources determined by the contractor. Backfill materials obtained from offsite sources are **not included** in the plans

earthwork summary table. See Quantity Summary Table Examples No. 4A – Borrow Project with Onsite Source for MSE Wall Backfill Materials and No. 4B – Borrow Project with Offsite Source for MSE Wall Backfill Materials in Appendix B.

Notes accompanying the plans Earthwork Summary Table should make it clear what the geotechnical determination or assumption (onsite or offsite) is for the source of MSE wall backfill materials. The earthwork Special Provisions should supplement the plans Earthwork Summary Table as needed to clarify the earthwork quantities shown, payment specifications, and adjustments required during construction in the event that the contractor changes the source of material from that assumed in the calculations.

MSE wall examples, showing the limits of embankment adjustments resulting from MSE wall backfills, are included in Appendix D.

### **708 – Mass Diagram**

The basic issue to be addressed in planning the movement of material from cuts to fills is the location of balance points. There are various ways of locating balance points and determining the distribution of yardage. The stations at which these two items approximately balance are taken as the balance points for yardage distribution.

By use of a mass diagram, as illustrated in [Figure 708.1](#), the Engineer gets a clear picture of the entire yardage distribution.

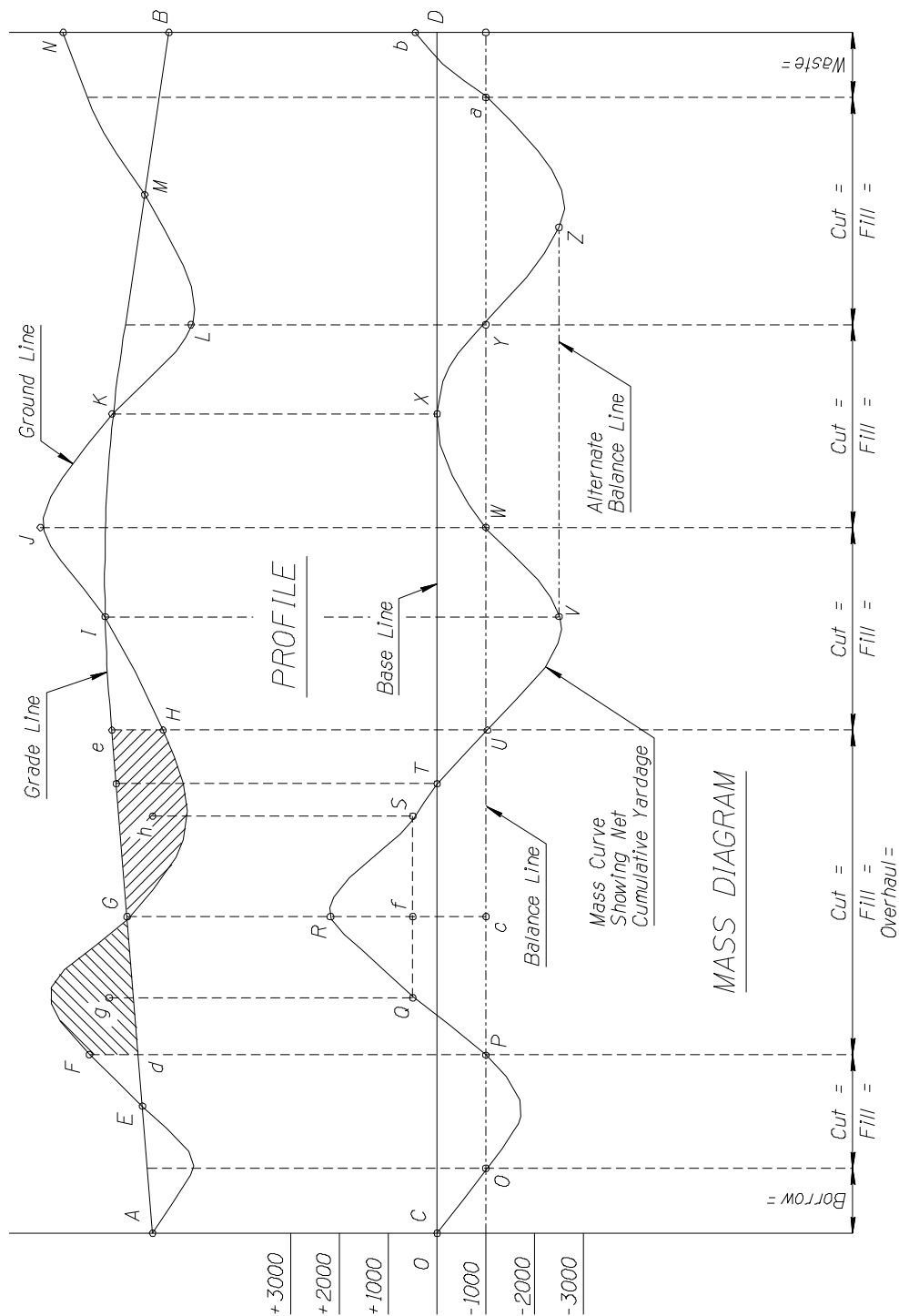

Cuts and fills are adjusted values.

**RELATIONSHIP BETWEEN  
PROFILE AND MASS DIAGRAM  
FIGURE 708.1**

As shown in [Figure 708.1](#), the mass diagram is plotted immediately below the centerline profile on which the final grade line *AB* is indicated. On the actual drawing, the abscissas of both the profile and mass diagram would be in 100-ft stations, the ordinates of the profile would be in ft of elevation, and the ordinates of the mass diagram would be in net cumulative yardage above or below the base line, *CD* in [Figure 708.1](#). An excess of cut is indicated in the mass diagram by an ordinate above the base line, and a deficiency is indicated by an ordinate below the base line. The ordinates for plotting the mass diagram are usually produced by the earthwork computer program. The abscissas on the mass diagram are generally laid off so that the station numbers increase from left to right, and the cumulative net yardage at each station is computed in the order in which the stations increase.

The following characteristics of a mass diagram should be kept in mind:

1. The mass curve itself represents the algebraic summation of *net* yardage from station-to-station.
2. The mass curve does not represent the exact total yardage of cut or fill. Between two successive 100-ft stations, there may be both cut and fill; and, in that case, the total adjusted cut and the total fill in the 100-ft length are added together algebraically and the algebraic sum of these two values is used in determining the net cumulative yardage that is plotted as the mass curve.
3. Cut, or plus, yardages are plotted upward and fill, or minus, yardages are plotted downward with reference to a given base line.
4. In the mass curve, the lowest point of a loop that forms a sag indicates the position of a change from fill to cut, and the highest point of a loop that forms a peak indicates the position of a change from cut to fill. Such points may not come directly below the points on the profile where the grade line intersects the ground line; because of the irregularities of cross slope in the topography involved, there may be a net cut or fill in the cross-section at the point where the grade line intersects the ground surface.
5. Between any two consecutive points where a horizontal line, or balance line, intersects the mass curve, the yardage is balanced. For example, in the loop PQRSTU, the net cut yardage on the mass diagram from P to R is balanced by the net fill yardage from R to U.
6. The maximum ordinate of any loop may be assumed to represent the net yardage that is to be moved from cut to fill, disregarding the yardage which is balanced within any 100-ft distance that has both cut and fill. Thus, in the case of the loop PQRSTU, the net yardage would be represented by  $R_c$ .
7. A balance line can be moved up or down on the diagram until the most desirable balance points are secured. The various balance lines do not need to be continuous, but a balance line can be stopped at any point where it intersects the mass curve. The vertical separation between two balance lines will indicate either shortage or excess.
8. The total yardage between successive balance points is indicated across the bottom of the page, as shown in [Figure 708.1](#) for the continuous balance line *Oa*. The yardages

between balance points must be sub-totaled from the yardage table and should not be scaled from the mass curve. If the balance points do not fall on even stations, proper interpolations should be made in the yardage table.

9. On a single roadway alignment, where a loop of the mass curve is above the balance line, as PQRSTU, the excavated material is to be moved in the direction in which the stations increase or from left to right in the mass diagram. Where a loop is below the balance line, as UVW, the material is to be moved in the opposite direction, or right to left in the mass diagram.

## **709 - Documentation Requirements**

### **709.1 - Earthwork to be shown on the Plans**

Earthwork information shall be provided on standard plan sheet format. Headings and title blocks are optional for each sheet. The following is the list of items that are required for earthwork on the Plans:

#### **Final Earthwork Summary**

A tabular summary of all the earthwork quantities on the project is to be shown on the plans. The summary shall include separate totals for all the earthwork quantities, including adjustments, see Figure 709.1 for each roadway or major drainage facility that is included in the project.

Construction phasing or sequencing shall be included in the summary tabulation if it occurs and it dictates the sequencing of earthwork operations. Separate totals for each phase are required to be shown on the plans.

All earthwork quantities must be summarized in one table, (regardless of being pay items or not).

A final check of quantities shown in the Earthwork Summary may be made by using the following formula: Total Excavation Material Available = Total Required Embankment Material. (See [Figure 709.1](#)).

#### **Topsoil Excavation Limits**

A graphic description including dimensions of the topsoil excavation is to be included in the Plans. The Topsoil Excavation Limit outline angle points to be shown with station and offset from the survey centerline and total area in Sq. Ft., depth of excavation and total topsoil excavation volume in Cu. Yd. are to be shown. (See Example No.1)

QUANTITIES SHOWN ON THE PLANS EARTHWORK SUMMARY TABLE<sup>1</sup>

Formula ( All quantities included inside the Earthwork Summary Table box must be in balance )

|  |          |   |
|--|----------|---|
| <b>TOTAL EXCAVATION MATERIAL AVAILABLE</b> | <b>=</b> | <b>TOTAL REQUIRED EMBANKMENT MATERIAL</b> |
|--|----------|---|

**All Excavation Types Are Positive Numbers ( + )**

**All Embankment Types are Negative Numbers ( - )**

| <b>EARTHWORK QUANTITY COMPONENTS</b>   |  |
|--|--|
| <ul style="list-style-type: none"> <li>• <b>Roadway Excavation<sup>2</sup></b><br/>Should Include When Applicable:<br/>Topsoil Excavation<br/>Overexcavation (Suitable for embankment)<br/>Overexcavation (Unsuitable material to be wasted)<br/>Benching (Cut Slopes) Excavation<br/>Collapsible Soils Excavation<br/>Erosion Protection Related Excavation<br/>(Not Included In Drainage Excavation)<br/>Excavation from Turnout, Detour and Road Connection<br/>Excavation Due to Removal of Existing Material Stockpile</li> <li>• <b>Drainage Excavation</b></li> <li>• <b>Structural Excavation</b><br/>Should Include When Applicable:<br/>Excavation from CBC, Drill Shaft, Retaining Wall and Bridge Abutment</li> <li>• <b>MSE Excavation</b></li> <li>• <b>Pipe Excavation</b></li> <li>• <b>Channel Excavation</b></li> <li>• <b>Haul In<sup>4</sup></b></li> <li>• <b>Borrow (Pit)</b></li> <li>• <b>Borrow (In Place)</b></li> <li>• <b>Swell</b></li> </ul> | <ul style="list-style-type: none"> <li>• <b>Embankment</b><br/>May Include When Applicable:<br/>Ground Compaction<br/>Pipe Backfill<sup>5</sup> (When Quantity is small % of embankment)<br/>Trench Backfill (When Quantity is small % of embankment)<br/>Structure Backfill<sup>5</sup> (When Quantity is small % of embankment)<br/>Berm &amp; Dike<br/>Embankment for Turnout, Detour and Road Connection<br/>Embankment (Material To Be Backfilled and Recompacted From Overexcavation)<br/>MSE Wall Embankment (Material To Be Backfilled and Recompacted From MSE Excavation)</li> <li><b>(Items Not Included in Embankment Above Should Be Listed Separately as Shown Below)</b></li> <li>• <b>Ground Compaction</b> (Projects with typically shallow fill slopes)</li> <li>• <b>Structure Backfill</b><br/>Should Include When Applicable:<br/>Backfill from CBC, Retaining Wall and Bridge Abutment</li> <li>• <b>MSE Wall Backfill (Structure, Reinforced &amp; Retained)</b><br/>(When Assumed to be Processed From Onsite Excavation)</li> <li>• <b>Trench Backfill</b></li> <li>• <b>Pipe Backfill</b></li> <li>• <b>Berm &amp; Dike</b></li> <li>• <b>Haul Out<sup>4</sup></b></li> <li>• <b>Waste</b></li> <li>• <b>Shrink</b></li> </ul> |

◊ **ADJUSTMENT TO EXCAVATION**

- Pavement Removal (If unsuitable for embankment)

◊ **ADJUSTMENTS TO EMBANKMENT**

- Pipe and CBC Embankment Adjustments<sup>3</sup>
- MSE Wall Backfill (Structure, Reinforced & Retained) Above Natural Ground Embankment Adjustments<sup>5</sup> (Backfill Material Assumed To Come From Offsite Source)

◊ Adjustments to excavation and embankment quantities are not summarized separately in the Earthwork Summary Table. However, the adjusted quantities should be fully documented in the earthwork calculations.

Notes:

1. Topsoil Plating (Roadway Excavation required @ 0% Shrink) should not be included in the Earthwork Summary Table. Topsoil Plating is summarized on the Design Sheet using a separate table.
2. The term "Roadway Excavation Available for Embankment" is used in the Earthwork Summary Table on projects with Topsoil Plating to account for the stockpiling of Roadway Excavation material suitable for Topsoil Plating (Roadway Excavation – Topsoil Plating = Roadway Excavation Available for Embankment).
3. Pipe and CBC Embankment Adjustments, normally deducted from embankment required, represent volume adjustments for Pipe and CBC structure above natural ground and volume adjustments for Pipe Backfill, Structure Backfill and Pipe Bedding above natural ground. These adjustments are included in the earthwork calculations and are not normally shown in the Earthwork Summary Table.
4. Haul In is treated as a positive ( + ) and Haul Out is treated as a negative ( - ). Haul In and Haul Out quantities are only included in the Earthwork Summary Table on projects requiring an earthwork phased construction sequence.
5. Pipe backfill and structure backfill quantities are normally assumed to be available from excavation quantities within the project except when a geotechnical investigation determines onsite material is unsuitable for one or more of the backfill quantities. Pipe backfill, structure backfill and MSE Wall backfill quantities predetermined to come from an offsite source are included in the earthwork calculations as embankment adjustments and are not listed separately in the Earthwork Summary Table. A note placed at the bottom of the Earthwork Summary Table should be used to clarify any assumptions made regarding material sources for backfill material.

**EARTHWORK SUMMARY TABLE  
QUANTITY CHECK  
FIGURE 709.1**

## 709.2 – Earthwork Documentation

### A) Documentation of Quantities – (Provided in a booklet):

All earthwork calculations shall be documented as required by Section 1040 Design Documentation in the project [Dictionary of Standardized Work Tasks](#).

All earthwork quantities and related quantities that impact the earthwork quantities, regardless of amount or method of payment, shall be accounted for in the earthwork documentation and earthwork summary.

#### 1) Station-to-Station Listing of Quantities:

The earthwork quantities for all roadway and drainage facilities shall be compiled in a station-to-station listing and summarized individually. The listing shall include end areas and quantities for the excavation, and embankment on **each** cross section used to determine the earthwork quantities. The listing shall also include the shrink or swell factor for the excavation.

Each of the items noted above may be provided in separate listings, however it is preferred that all the items be shown on the same listing.

(See Attached Examples)

**Note:** A separate listing or group of listings is required for each roadway and drainage facility.

The following shall be included in the listings,: Excavation End Areas (Sq. Ft.), Roadway Excavation (Cu. Yd.) Shrink or Swell (Cu. Yd.), Embankment End Areas (Sq. Ft.), Embankment (Cu. Yd.), Ground Compaction (Cu. Yd.), unless listed separately, Net Excavation and Net Embankment (Cu. Yd.), Mass Ordinate.

#### 2) Other Earthwork Supporting Quantities and Calculations:

All other Earthwork items listed in [Figure 709.1](#) shall be supported with documentation of calculations. Sketches shall be included to clarify and support the methodology as needed.

#### 3) Plotted Cross Sections:

Cross section plots are not normally part of the Bid Documents, but may be included in special cases to clarify intent of design. Cross sections shall be plotted using the appropriate spacing and scale to clearly depict all roadway elements, including curb and gutter, where applicable. All cross sections shall be plotted using a true scale where the vertical and horizontal scales are the same.

Preferred Scale for 22"x34" Size standard plan sheets: 1"=20' horizontal, 1"=20' vertical (1"=5' or 1"=10' horizontal and vertical are also acceptable if special conditions warrant). Cross section plots shall include as a minimum: plotted cross sections at each full station plus at appropriate breaks, finished grade roadway template(s) including the subgrade superimposed on the natural terrain (dashed line) and should include: new centerline and grade elevation of the controlling roadway for each section, horizontal and vertical datum lines, existing centerline, slope rates (X.X:1) of the last segment, right-of-way limits. In the case of phased construction with overlapping slopes, indicate location of quantity split between the roadways. Slope rate information may be provided separately in a station-by-

station listing as an alternative. Manually plotted cross sections shall be drawn on vellum grid paper. CADD computer generated cross sections should be plotted with a 1" grid and should have appropriate horizontal and vertical tick marks (10 tick marks per in.) with 1" datum annotations.

Cross sections shall be legible and clear when reduced to 50% size for review. All plotting shall be on vellum paper suitable for reproduction. (See Attached – Examples)

### **710-Quality Procedures**

Quality Control Procedures of earthwork quantity computations has to be an integral part of the Quality Control Plan for the project. Due to the significant costs associated with earthwork construction, the accuracy of the earthwork constitutes a critical part of the project's budget. The earthwork computation documentation, all the worksheets, computer input data and cross section plots have to be checked before submittal to the department, and the responsible checker's initials shown on every sheet of calculation, plan or computer plot. The Designer of Record is responsible for the reasonable accuracy and systematic checking of all the earthwork quantities.

### **711-Software**

ADOT has no earthwork computer software vendor requirement. The requirements for any computer software's computational methods are: the ability to compute earthwork with the average-end-area method, the ability to account for ground compaction, shrinkage and swell, the ability to apply ADOT's standard slopes to the roadway templates, and the ability to plot cross sections with all the ADOT required annotations at the specified scale.

### **712-Other Considerations**

The following are a collection of considerations, gathered from previous design and construction experiences, to assist the designer in earthwork evaluation.

#### **Constructability Issues:**

- If a project is located within Federal land, a National Forest, State Land or Native American Indian Reservations, check local requirements. Are there restrictions on access to site, available construction staging, waste or borrow sites or other sensitive environmental issues?
- Is special treatment of finished slopes required due to environmental and visual constraints from other agencies? Who is to approve the slope treatment and how is it to be paid for?
- Is there an available site for stockpiling materials?
- Can materials removed from existing roadway be used elsewhere on the project?
- Is earthwork phasing compatible with the actual construction and traffic control plan of the job? Define the earthwork needs in each stage. Does each stage balance, or does it require borrow or waste? Is the proposed source of embankment available or presently under traffic?

- 
- Is there a temporary stockpile site on the project for any excess excavation that will be needed for future stage?
  - Are shrink and swell factors consistent with previous projects in the same vicinity?
  - When earthwork is tabulated for a large project, and it appears that the job will come close to balancing, consider a contingency plan for disposal of and need for additional material.
  - If there is a choice on designing a project with waste or borrow, is this a section within a planned corridor that can be used to balance another project? Can you avoid designing adjacent waste and borrow jobs that do not bid concurrently?
  - What is more economical to deal with – borrow or waste? Consider local conditions for borrow availability or waste sites. Is the waste material dirt or rock? Can the project accommodate the waste quality with widening, pullouts, slope flattening, or berms? If additional excavation is needed to balance embankment, can cuts be flattened or daylighted?
  - On large earthwork jobs, where it is necessary to haul over existing roadways, designate areas for temporary crossings, or detours so that off-highway equipment can be used.
  - Consider excavation types for phasing purposes. If job has mix of soil and rock, what material is available when it is time to finish subgrade? Will it be necessary to import borrow?
  - If drill-and-shoot is required, evaluate how traffic will be impacted by construction equipment and methodology.
  - Will shallow embankment sections accommodate anticipated rock size?
  - When the contractor encounters rock excavation to construct subgrade, the specifications require overexcavation by 6". This additional quantity is not calculated and not included in the roadway excavation quantities.
  - Is topsoil plating required? If so, is there an available source – on-site or off-site? If existing surface material is to be stripped and stockpiled, is there an area available within the Right-of-way for storage? Will the existing surface provide the required quantity? Will soil amendments or material screening be needed?
  - If slope plating is required, are the slope ratios flat enough to assure reasonable plating with standard equipment?
  - Is the right-of-way adequate to accommodate earthwork operations?



## **APPENDIX A**

### **ROADWAY DESIGN POLICIES AND PROCEDURES**

## **APPENDIX A**

### **ROADWAY DESIGN POLICIES AND PROCEDURES**

From time-to-time, the ADOT Roadway Engineering Group develops policy positions on items which are roadway design related but which have significant impact outside the design process. To assure that these policies are widely disseminated, the Roadway Engineering Group distributes the Roadway Design Policies and Procedures throughout ADOT and to its partners in the design and construction process.

The content of the Roadway Design Policies and Procedures are referenced in the appropriate chapters of the Roadway Design Guidelines but to avoid duplication and possible confusion, the substance is not repeated therein.

### **CONTENTS**

"Turnout Paving in PM<sub>10</sub> Non-Attainment Areas". ADOT Roadway Engineering Group:  
April 6, 1995.

"A Policy for Paving Turnouts". ADOT Roadway Engineering Group: December 18, 1995.

HIGHWAYS DIVISION  
POLICY AND PROCEDURE MEMO NO. 95-01  
ROADWAY ENGINEERING GROUP

EFFECTIVE DATE: 02-01-95  
REISSUE DATE:  
REVIEW DATE: 01-96  
NO. OF PAGES 5

TITLE: TURNOUT PAVING IN PM<sub>10</sub> NON-ATTAINMENT AREAS

APPROVED: \_\_\_\_\_

  
STATE ENGINEER

**PURPOSE:**

The purpose of this policy is to establish a procedure to provide for the surface treatment of side access roads (turnouts) within state right of way for the purpose of reducing suspended dust particles and to reduce tracking of mud and dirt onto the state highway system in PM<sub>10</sub> Non-Attainment Areas.

**POLICY:**

It is the policy of the Arizona Department of Transportation to provide a bituminous driving surface within ADOT right of way for permitted side roads and turnouts which access the state highway in designated non-attainment areas of the state in Suspended Particulate Matter (PM<sub>10</sub>).

This procedure will apply to state highway construction projects within the boundaries of the attached PM<sub>10</sub> Non-Attainment Area map when paving operations are an integral part of new construction, reconstruction, and pavement preservation projects.

**DEFINITIONS:**

Non-Attainment Area is a designation given to an area which exceeds the allowable federal standards for air contaminants.

PM<sub>10</sub> - solid particles small enough (10 microns) to remain suspended in air and can cause a health hazard if inhaled.

**IMPLEMENTATION:**

Turnouts proposed to be surfaced within ADOT right of way in conjunction with a construction project will require the property owner to obtain a "Permit to Use State Highway Right of Way" from District prior to construction of the project. Turnouts without signed permits will not be paved by ADOT.

In areas where ADOT construction projects are located in easements from Federal or other agencies, all efforts will be made to surface turnouts through agreement with the agency. If an agency requests not to pave at specific locations, the request will be honored.

Turnouts to be surfaced will be called out and dimensioned on the construction plans. Surfacing thickness and material type will be indicated on the plans. Pavement treatment will be provided by Materials Group Pavement Design. (See attached list of surfacing alternatives).

When existing ADOT right of way or easement exceeds 100' (30m) from mainline centerline, then new paving limits will normally terminate at 30m±.

Access granted by Districts through new permits not in conjunction with ADOT construction projects will require a paved surface by the permittee.

Projects in PM<sub>10</sub> Non-Attainment Areas will be identified in the Project Assessment document. Detailed maps of the Non-Attainment PM<sub>10</sub> Areas are available from ADOT Environmental Planning Section.

In urban and suburban areas where existing wide areas are being utilized, the designer and District shall evaluate to determine the appropriate areas to surface. Interface with property owners may be required. Standard turnout widths shall be utilized to the extent possible.

**Pavement Preservation Project Guidelines:**

- a) Changes in turnout profile grade will not normally be undertaken as a part of this program.
- b) Reshaping and compacting of existing turnouts prior to paving may be required as determined by District and design. If reshaping and compacting is required, it shall be indicated in the plans or specifications.
- c) The width of existing turnouts will remain the same. Widening of existing turnouts will not be undertaken except in special circumstances where District may support a functional change, e.g., local access to commercial access.
- d) Changes in fencing, gates or cattle guards are not a part of this program.

SUSPENDED PARTICULATE MATTER (PM<sub>10</sub>)  
NON-ATTAINMENT AREAS  
IN ARIZONA

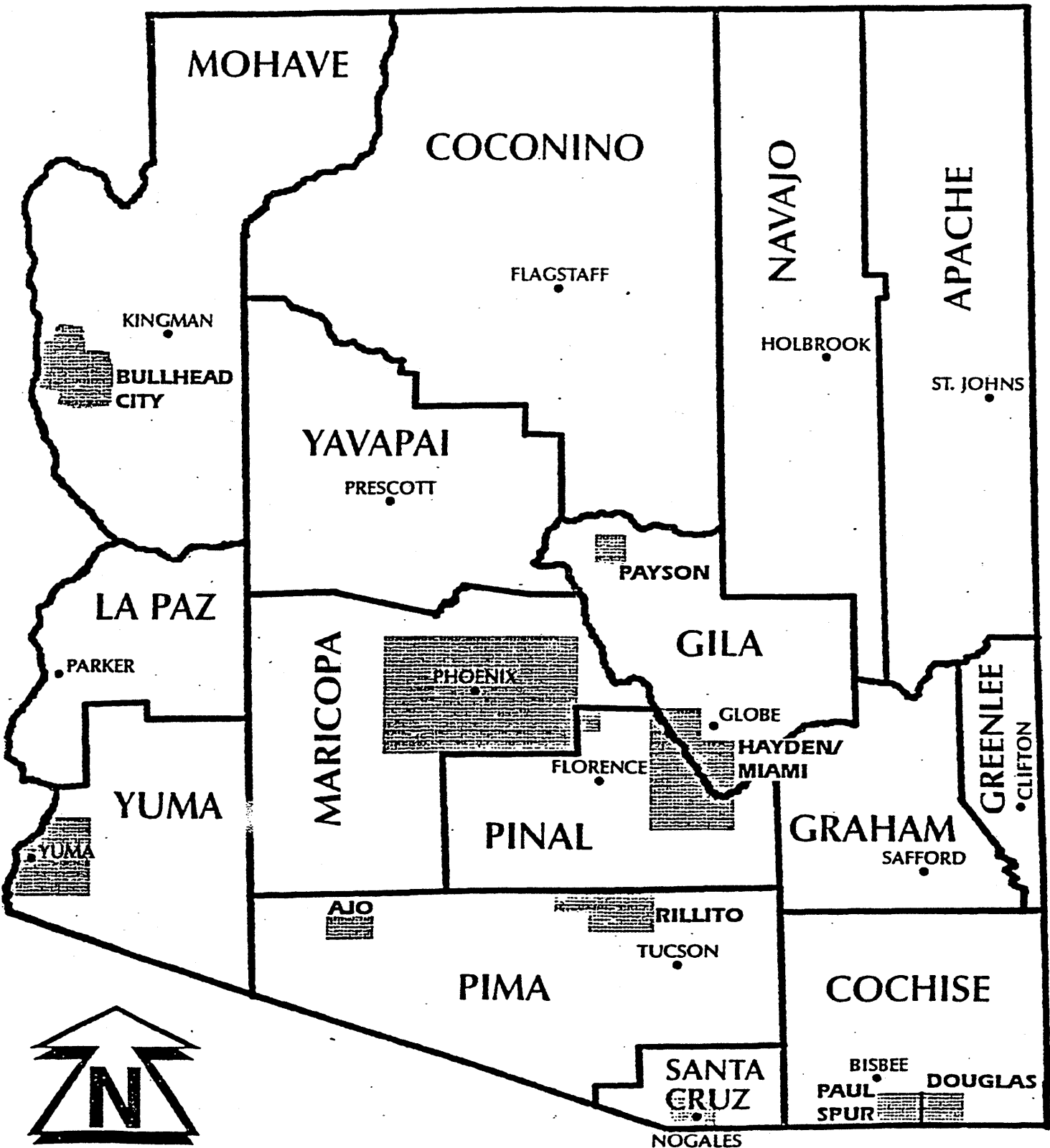

# SURFACING GUIDE FOR TURNOUTS AND INTERSECTING ROADWAYS

## NEW CONSTRUCTION PROJECTS

### Major Intersecting Roadways

1. < 50 meters - Same as Mainline
2. > 50 meters - Use AASHTO Design or Minimum Structural Number

### Major/Commercial Turnouts

1. 3" AC / 6" AB
2. Mainline AC Thickness / 4" AB
3. Mainline AC Thickness on Subgrade

### Minor Turnouts

1. 2" AC / 4" AB
2. Mainline AC Thickness on Subgrade

### Gravel Turnouts (Non-Paved)

1. 6" AB With or Without Bituminous Treatment

## PAVEMENT REHABILITATION PROJECTS

### Major Intersecting Roadways

1. Match Existing Pavement Section
2. Meet Minimum Structural Number

### Major/Commercial Turnouts

1. 3" AC / 6" AB or 3" AC / 6" Milled AC
2. 4" AC on Subgrade

### Minor Turnouts

1. 2" AC / 4" AB or 2" AC / 4" Milled AC
2. 3" AC on Subgrade
3. 6" AB or 6" Milled AC (with Bituminous Treatment)

### Gravel Turnouts (Non-Paved)

1. 6" AB or 6" Milled AC  
(with Bituminous Treatment)

Note: Roadway Design will determine turnout classification and Pavement Design will determine surfacing type.



**ARIZONA DEPARTMENT OF TRANSPORTATION**

**ROADWAY ENGINEERING GROUP**

**DESIGN SECTION**

***“A POLICY FOR PAVING TURNOUTS”***

**DECEMBER 18, 1995**

**(Supersedes “Policy on Paving Turnouts” January 18, 1991)**

**See also Highways Division Policy and Implementation Memorandum No. 95-01 entitled “TURNOUT PAVING IN PM<sub>10</sub> NON-ATTAINMENT AREAS” - effective date February 1, 1995.**

## **“A POLICY FOR PAVING TURNOUTS”**

This policy is intended to provide guidance for design and district personnel in providing surface treatments for turnouts and driveways. This policy applies statewide except in PM<sub>10</sub> Non-attainment areas. It is intended to be utilized with good engineering judgment. It is recognized that there may be exceptions for specific cases. Place pavement where there is a justifiable reason for doing so, not solely because asphaltic concrete is a superior surface. The District is responsible for review and implementation of necessary permit actions.

### **I. PAVEMENT PRESERVATION PROJECTS**

#### **A. Rural (No Curb & Gutter)**

1. Existing Turnout Unpaved
  - a) Turnout will remain unpaved.
  - b) Turnout may be paved to radius return if it is determined to be moderate to high use (i.e., multi-party, business, commercial, recreational, etc.).
  - c) Where there is very strong justification demonstrated from a District maintenance or high usage standpoint, selective turnouts may be paved to the R/W line or 100' ± from roadway centerline, whichever is less. This treatment will be considered the exception rather than the rule, and shall be agreed upon by the Project Team.
2. Existing Turnout Paved
  - a) Turnout may be overlaid to the limit of existing paving within the R/W.
  - b) In very limited applications where the existing turnout is paved to the radius return, the surface may be extended to the R/W or 100' ± from centerline, but only where there is strong justification evident as in I-A-1-c. Alternate materials such as milled AC or treated AB shall be considered to perform this work.

## II. WIDENING & RECONSTRUCTION PROJECTS

### A. Rural (No Curb & Gutter)

#### 1. Existing Turnout Unpaved

- a) Reconstructed turnout will remain unpaved if it is a low usage turnout.
- b) Reconstructed turnout may be paved to radius return if determined to be moderate usage.
- c) Turnout may be paved to R/W or 100'  $\pm$  from roadway centerline at limited locations when justified as in I-A-1-C.

#### 2. Existing Turnout Paved

- a) Reconstructed turnout to be paved in accordance with pavement treatment of the existing turnout.
- b) Existing turnouts paved to radius return may be extended at limited locations as described and justified under I-A-2-b.
- c) When the limits of a reconstructed turnout fall outside the R/W, paving limits will be treated as per II-A-2-a but may be extended to the tie-in location as determined by the designer to better match existing profile and pavement conditions.

### B. Urban (Driveways Beyond C&G or C&G&SW)

1. Existing conditions will generally remain, however, driveway surface treatments will be reviewed to determine suitability with existing conditions. Pavement may be included as necessary to improve existing conditions if deemed appropriate by Design and District through review. Paving may also be required as a new R/W mitigation measure.

### **III. NEW CONSTRUCTION**

#### **A. Rural (No Curb & Gutter)**

- a) Low volume turnouts will normally be unpaved but may be paved to the radius return if determined necessary by District.
- b) Moderate and high volume turnouts will be paved to the R/W. Paving beyond the R/W may be warranted. See Section II-A-2-b.

#### **B. Urban (C&G or C&G&SW)**

- 1. Same as II-B-1.

2122pav

**Appendix B**

**Earthwork Examples**

## INDEX

### EARTHWORK EXAMPLES

|   | <b>No. of Pages</b> |
|---|---------------------|
| <b>BASIC EARTHWORK CALCULATIONS</b>   |                     |
| <b>BASIC EXAMPLE NO. 1:</b> Sample Calculation with Shrink  | 1                   |
| <b>BASIC EXAMPLE NO. 2:</b> Sample Calculation with Swell   | 1                   |
| <b>NOTES TO BASIC EXAMPLES 3-6</b>  | 1                   |
| Examples with More Net Embankment than Net Excavation   |                     |
| <b>BASIC EXAMPLE NO. 3:</b> Excavation with Shrink and Haul In with Swell   | 1                   |
| <b>BASIC EXAMPLE NO. 4:</b> Excavation with Swell and Borrow with Shrink  | 1                   |
| Examples with Less Net Embankment than Net Excavation   |                     |
| <b>BASIC EXAMPLE NO. 5:</b> Excavation with Shrink and Haul Out   | 1                   |
| <b>BASIC EXAMPLE NO. 6:</b> Excavation with Swell and Waste   | 1                   |
| <b>EARTHWORK CALCULATIONS PROJECT EXAMPLES</b>  |                     |
| <b>PROJECT EXAMPLE NO. 1:</b> Four-Lane Divided Roadway<br>(New EB, Widened WB)                                       | 10                  |
| <b>PROJECT EXAMPLE NO. 2:</b> Single Roadway Reconstruction<br>Project with Waste Material                            | 1                   |
| <b>PROJECT EXAMPLE NO. 3:</b> Single Roadway Reconstruction<br>Project with Borrow                                    | 1                   |
| <b>PROJECT EXAMPLE NO. 4:</b> Pavement Preservation and Climbing<br>Lane Project                                      | 1                   |
| <b>QUANTITY SUMMARY TABLE EXAMPLES</b>  |                     |
| <b>QUANTITY SUMMARY TABLE EXAMPLE NO. 1:</b> Roadway Widening<br>Project  | 1                   |
| <b>QUANTITY SUMMARY TABLE EXAMPLE NO. 2:</b> Urban Freeway Project with<br>Construction Phasing                       | 1                   |
| <b>QUANTITY SUMMARY TABLE EXAMPLE NO. 3A:</b> Waste Project with Onsite<br>Source for MSE Wall Backfill<br>Materials  | 1                   |
| <b>QUANTITY SUMMARY TABLE EXAMPLE NO. 3B:</b> Waste Project with Offsite<br>Source for MSE Wall Backfill<br>Materials | 1                   |
| <b>QUANTITY SUMMARY TABLE EXAMPLE NO. 4A:</b> Borrow Project with Onsite<br>Source for MSE Wall Backfill<br>Materials | 1                   |

|  |   |
|--|---|
| <b>QUANTITY SUMMARY TABLE EXAMPLE NO. 4B:</b> Borrow Project with Offsite Source for MSE Wall Backfill Materials | 1 |
|--|---|

### **CROSS SECTION EXAMPLES**

|   |   |
|---|---|
| <b>CROSS SECTION EXAMPLE:</b> 2-Lane Rural Highway  | 1 |
| <b>CROSS SECTION EXAMPLE:</b> Rural Divided Highway | 1 |
| <b>CROSS SECTION EXAMPLE:</b> Urban Freeway         | 1 |

### **PIPE EXCAVATION AND BACKFILL COMPUTATIONS**

|   |   |
|---|---|
| <b>PIPE EXCAVATION EXAMPLE NO. 1:</b> Calculation Summary | 1 |
|---|---|

### **EARTHWORK EXAMPLES, CONT'D**

|  | <b>No. of Pages</b> |
|--|---------------------|
| <b>URBAN HIGHWAY EARTHWORK CALCULATIONS EXAMPLE</b>    |                     |
| <b>URBAN EXAMPLE NO. 1:</b> Urban Highway with Topsoil | 13                  |
| <b>TOPSOIL EXCAVATION EXAMPLES</b>                     |                     |
| <b>TOPSOIL EXAMPLE NO. 1:</b> Sample Plan Sheet        | 1                   |
| <b>TOPSOIL EXAMPLE NO. 2:</b> Topsoil Plating Diagram  | 1                   |
| <b>CONTOUR GRADING EXAMPLES</b>                        |                     |
| <b>CONTOUR GRADING EXAMPLE NO. 1:</b>                  | 1                   |
| <b>CONTOUR GRADING EXAMPLE NO. 2:</b>                  | 1                   |
| <b>MSE Wall Examples</b>                               | <b>1</b>            |
| <b>No. 1 Side Hill Location</b>                        | 1                   |
| <b>No. 2 Bottom of Leveling Pad in Cut</b>             | 1                   |
| <b>No. 3 Bottom of Leveling Pad in Fill</b>            | 1                   |

## **BASIC EARTHWORK CALCULATIONS**

### **BASIC EXAMPLE NO. 1: Sample Calculation with Shrink**

Compute the amount of excavation required to make 500.0 C.Y. of embankment if the excavation has a shrink factor of 0.10 (10 percent).

**Given:**    **E =**                    **500**  
               **Shr =**                **0.1**

Equation:  $E = F \times X$  (Embankment = Calculation Factor x Excavation)

where:    E= Embankment Volume  
              X = Required Excavation  
              F = Calculation Factor (Shrink or Swell expressed as a ratio to 1.0) (Shrink = "-", Swell = "+")  
              = (1 + Shrink/Swell Factor)

**Step 1: Determine the Calculation Factor for Excavation**

$F = 1 + \text{Shrink Factor}$   
 $= 1 + (-0.10) = 0.90$

**Step 2: Calculate the required excavation**

$X = E / F$   
 $= 500.0 / .9$   
 $= 555.56$

Use            = 556.0

**Check:**

Step 1: Determine amount of shrinkage  
 10 percent of X = 0.10 (556.0) = 55.6 => Use 56.0

Step 2: Excavation minus shrinkage = embankment  
 $556.0 - 56.0 = 500.0$

**BASIC EARTHWORK CALCULATIONS****BASIC EXAMPLE NO. 2: Sample Calculation with Swell**

Compute the amount of excavation required to make 500.0 C.Y. of embankment if the excavation has a swell factor of 0.10 (10 percent).

**Given:**    **E =**                    **500**  
              **Swl =**                **0.1**

Equation:  $E = F \times X$  (Embankment = Calculation Factor x Excavation)

where:    E= Embankment Volume  
              X = Required Excavation  
              F = Calculation Factor (Shrink or Swell expressed as a ratio to 1.0) (Shrink = "-", Swell = "+")  
              = (1 + Shrink/Swell Factor)

**Step 1: Determine the Calculation Factor for excavation**

$F = 1 + \text{Swell Factor}$   
 $= 1 + (+0.10) = 1.10$

**Step 2: Calculate the required excavation**

$X = E / F$   
 $= 500.0 / 1.10$   
 $= 454.55$

Use            = 455.0 C. Y.

**Check:**

Step 1:    Determine amount of swell  
              10 percent of X = 0.10 (455.0) = 45.5 => Use 45.0

Step 2:    Excavation plus swell = embankment  
              455 + 45.0 = 500.0

## **BASIC EARTHWORK CALCULATIONS**

### **Notes to Basic Examples 3 - 6**

There are two basic methods of computing the amount of shrink for any earthwork total or sub-total. The first method (Basic Examples 3 and 4) is to be used when there is **more net embankment** than there is **net excavation** in the area (sub-total) being considered. The second method (Basic Examples 5 and 6) shall be used when there is **less net embankment** available than there is **net excavation** in the area (sub-total) being considered. Examples 3 and 5 are for excavation with shrink, examples 4 and 6 are for excavation with swell.

The first step in calculating the total shrink or swell quantity on any area (sub-total) within the project is to separate and sub-total all the quantities at each point (location) where the shrink or swell factor changes. The shrink or swell quantity can then be calculated separately for each different sub-total depending on which of the basic method applies.

## BASIC EARTHWORK CALCULATIONS

### More Net Embankment Than Net Excavation

#### BASIC EXAMPLE NO. 3: Excavation with Shrink and Haul In with Swell

| Initial Quantities |        | Intermediate Quantities |        | Final Quantities    |      |
|--------------------|--------|-------------------------|--------|---------------------|------|
| Excavation         | 500.0  | Excavation              | 500.0  | Excavation          | 500  |
| 10% Shr            | ?      | 10% Shr                 | 50.0   | 10% Shr             | 50   |
| Embankment         | 1000.0 | Embankment              | 1000.0 | * Embankment        | 1075 |
| Gnd Comp           | 75.0   | Gnd Comp                | 75.0   | Haul In             | 595  |
|                    |        | Net Shortage            | 625.0  | 5% Swell            | 30   |
|                    |        |                         |        | * Includes Gnd Comp |      |

**Step 1. Compute the excavation shrink amount and net excavation amount:**

Since there is more net embankment than net excavation, the shrink factor is applied to all the excavation.

$$\begin{aligned} \text{(excavation)} 500.0 \times \text{(shrink factor)} 0.10 &= \text{(shrink)} 50.0 \\ \text{(excavation)} 500.0 - \text{(shrink)} 50.0 &= \text{(net excavation)} 450.0 \end{aligned}$$

**Step 2. Compute the net embankment and net shortage:**

Compute the net embankment and subtract the net excavation from the net embankment.

$$\begin{aligned} \text{(embankment)} 1000.0 + \text{(gnd comp)} 75.0 &= \text{(net embankment)} 1075.0 \\ \text{(net excavation)} &- 450.0 \\ \hline \text{(net shortage)} &= 625.0 \end{aligned}$$

**Step 3. Determine source for the net shortage (haul in or borrow):**

Determine where the material to make up the shortage will come from. If the material is coming from another area (sub-total) within the project, identify the quantity as haul in. If the material is to come from outside the project limits, identify the quantity as borrow. For this example, assume the source to be another area (sub-total).

**Step 4. Compute the haul in amount:**

Divide the net shortage by the calculation factor for the haul in (1 + Shrink/Swell)

The swell factor for the haul in material is 5% for this example.

$$\text{(net shortage)} 625.0 / (1.00 + \text{swell factor}) 1.05 = \text{(haul in)} 595.0$$

**Step 5. Compute the haul in swell amount and net haul in amount:**

$$\begin{aligned} \text{(haul in)} 595.0 \times \text{(swell factor)} 0.05 &= \text{(swell)} 30.0 \\ \text{(haul in)} 595.0 + \text{(swell)} 30.0 &= \text{(net haul in)} 625.0 \end{aligned}$$

**Step 6. Add up all net excavation and verify final quantities:**

Add up all the net excavation (net excavation + net haul in). Check all quantities to insure net excavation is equal to the net embankment.

$$\begin{aligned} \text{(net excavation)} 450.0 + \text{(net haul in)} 625.0 &= \text{(net excavation)} 1075.0 \\ \text{(net embankment)} &- 1075.0 \\ \hline \text{Quantities check out} &= 0.0 \quad \checkmark \end{aligned}$$

The following is another method of verifying the quantities:

$$\begin{aligned} \text{(excavation)} 500.0 - \text{(shrink)} 50.0 + \text{(haul in)} 595.0 + \text{(swell)} 30.0 - \\ \text{(net embankment)} 1075.0 &= 0.0 \text{ Quantities check out } \checkmark \end{aligned}$$

## BASIC EARTHWORK CALCULATIONS

### More Net Embankment Than Net Excavation

#### BASIC EXAMPLE NO. 4: Excavation with Swell and Borrow with Shrink

| Initial Quantities |        | Intermediate Quantities |        | Final Quantities    |      |
|--------------------|--------|-------------------------|--------|---------------------|------|
| Excavation         | 500.0  | Excavation              | 500.0  | Excavation          | 500  |
| 10% Swl            | ?      | 10% Swl                 | 50.0   | 10% Swl             | 50   |
| Embankment         | 1000.0 | Embankment              | 1000.0 | * Embankment        | 1075 |
| Gnd Comp           | 75.0   | Gnd Comp                | 75.0   | Borrow              | 618  |
|                    |        | Net Shortage            | 525.0  | 15% Shr             | 93   |
|                    |        |                         |        | * Includes Gnd Comp |      |

**Step 1. Compute the excavation swell amount and net excavation amount:**  
 Since there is more net embankment than net excavation, the swell factor is applied to all the excavation.

$$\begin{aligned} \text{(excavation)} 500.0 \times \text{(swell factor)} 0.10 &= \text{(swell)} \quad \quad \quad \mathbf{50.0} \\ \text{(excavation)} 500.0 + \text{(swell)} 50.0 &= \text{(net excavation)} \quad \mathbf{550.0} \end{aligned}$$

**Step 2. Compute the net embankment and net shortage:**  
 Compute the net embankment and subtract the net excavation from the net embankment.

$$\begin{aligned} \text{(embankment)} 1000.0 + \text{(gnd comp)} 75.0 &= \text{(net embankment)} \quad \mathbf{1075.0} \\ \text{(net excavation)} &\quad - 550.0 \\ \text{(net shortage)} &\quad \quad \quad \mathbf{525.0} \end{aligned}$$

**Step 3. Determine source for the net shortage (haul in or borrow):**  
 Determine where the material to make up the shortage will come from. If the material is coming from another area (sub-total) within the project, identify the quantity as haul in. If the material is to come from outside the project limits, identify the quantity as borrow. For this example, assume the source to be outside the project limits, therefore it is from borrow.

**Step 4. Compute the borrow amount:**  
 Divide the net shortage by the calculation factor (1.0 + Shrink/Swell Factor) of the borrow. The shrink factor for the borrow material is 15% for this example.

$$\text{(net shortage)} 525.0 / (1.00 + (-.15)) 0.85 = \text{(borrow)} \quad \mathbf{618.0}$$

**Step 5. Compute the borrow shrink amount and net borrow amount:**

$$\begin{aligned} \text{(borrow)} 618.0 \times \text{(shrink factor)} 0.15 &= \text{(shrink)} \quad \quad \quad \mathbf{93.0} \\ \text{(borrow)} 618.0 - \text{(shrink)} 93.0 &= \text{(net borrow)} \quad \mathbf{525.0} \end{aligned}$$

**Step 6. Add up all net excavation and verify final quantities:**  
 Add up the net excavation (net excavation + net borrow). Check all quantities to insure net excavation is equal to the net embankment.

$$\begin{aligned} \text{(net excavation)} 550.0 + \text{(net borrow)} 525.0 &= \text{(net Excavation)} \quad \mathbf{1075.0} \\ \text{(net embankment)} &\quad - 1075.0 \\ \text{Quantities check out} &= \mathbf{0.0} \quad \checkmark \end{aligned}$$

The following is another method of verifying the quantities:

$$\begin{aligned} \text{(excavation)} 500.0 + \text{(swell)} 50.0 + \text{(borrow)} 618.0 - \text{(borrow shrink)} 93.0 - \\ \text{(net embankment)} 1075.0 &= \mathbf{0.0} \text{ Quantities check out} \quad \checkmark \end{aligned}$$

## BASIC EARTHWORK CALCULATIONS

### Less Net Embankment Than Net Excavation BASIC EXAMPLE NO. 5: Excavation with Shrink and Haul Out

| Initial Quantities |        | Intermediate Quantities |        | Final Quantities |        |
|--------------------|--------|-------------------------|--------|------------------|--------|
| Excavation         | 1500.0 | Excavation              | 1500.0 | Excavation       | 1500.0 |
| 10% Shr            | ?      | Required Excav          | 1194.0 | 10% Shr          | 119.0  |
| Embankment         | 1000.0 | 10% Shr                 | 119    | * Embankment     | 1075.0 |
| Gnd Comp           | 75.0   | Embankment              | 1000.0 | Haul Out         | 306.0  |
|                    |        | Gnd Comp                | 75.0   |                  |        |
|                    |        | Excess Material         | 306.0  |                  |        |

\* Includes Gnd Comp

**Step 1. Compute the net embankment:**

Add the embankment and gnd compaction together.  
 (embankment) 1000.0 + (gnd comp) 75.0 = **(net embankment) 1075.0**

**Step 2. Compute the excavation amount required and excavation shrink amount:**

Compute the excavation amount required by dividing the net embankment amount by the calculation factor for the excavation (1.0 + Shrink/Swell Factor).  
 (net embankment) 1075.0 / (1 + (-0.10)) 0.90 = **(required excavation) 1194.0**

The excavation shrink amount can now be computed.  
 (required excavation) 1194.0 x (shrink factor) 0.10 = **(shrink) 119.0**

**Step 3. Compute the excess material:**

Subtract the required excavation from the excavation.  
 (excavation) 1500.0 - (required excavation) 1194.0 = **(excess material) 306.0**

**Step 4. Determine target of excess material:**

Determine where the excess material from this area (sub-total) will be taken. If the material is going to another area (sub-total) within the project, identify the quantity as haul out. If the material is to go outside the project limits, identify the quantity as waste. Assume the target to be another area (sub-total) within the project limits for this example. **Haul out = 306.0 (No shrink factor applied.)**

**Step 5. Verify final quantities including required excavation:**

Verify net embankment plus shrink is equal to required excavation.  
 (net embankment) 1075.0 + (shrink) 119.0 = **(required Excavation) 1194.0**

Check all quantities to ensure balance.  
 (excavation 1500.0 - (shrink) 119.0 - (net embankment) 1075.0 - (haul out) 306.0 = **0.0**   
**Quantities Check**

**BASIC EARTHWORK CALCULATIONS**

**Less Net Embankment Than Net Excavation**

**BASIC EXAMPLE NO. 6: Excavation with Swell and Waste**

**Basic Example No. 6 - Net Embankment Less Than Net Excavation:  
Excavation with Swell and Waste**

| Initial Quantities | Intermediate Quantities | Final Quantities    |
|--------------------|-------------------------|---------------------|
| Excavation 1500.0  | Excavation 1500.0       | Excavation 1500     |
| 10% Swl ?          | Required Excav 977.0    | 10% Swl 98          |
| Embankment 1000.0  | 10% Swl 98.0            | * Embankment 1075   |
| Gnd Comp 75.0      | Embankment 1000.0       | Waste 523           |
|                    | Gnd Comp 75.0           |                     |
|                    | Excess Material 523.0   | * Includes Gnd Comp |

**Step 1. Compute the net embankment:**  
 Add the embankment and ground compaction together.  
 applied to all the excavation.  
 (embankment) 1000.0 + (gnd comp) 75.0 = **(net embankment) 1075.0**

**Step 2. Compute the excavation amount required and excavation shrink amount:**  
 Compute the excavation amount required by dividing the net embankment amount by the calculation factor for the excavation (1.0 + Shrink/Swell Factor).  
 (net embankment) 1075.0 / (1 + (+0.10)) 1.10 = **(required excavation) 977.0**

The excavation swell amount can now be computed.  
 (required excavation) 977.0 x (swell factor) 0.10 = **(swell) 98.0**

**Step 3. Compute the excess material:**  
 Subtract the required excavation from the excavation.  
 (excavation) 1500.0 - (required excavation) 977.0 = **(excess material) 523.0**

**Step 4. Determine target of excess material:**  
 Determine where the excess material from this area (sub-total) will be taken. If the material is going to another area (sub-total) within the project, identify the quantity as haul out. If the material is to go outside the project limits, identify the quantity as waste. Assume that the excess material is to be wasted outside the project limits for this example. **Waste = 523.0 (No swell factor applied.)**

**Step 5. Verify final quantities including required excavation:**  
 Verify net embankment is equal to required excavation plus swell.  
 (required excavation) 977.0 + (swell) 98.0 = **(net embankment) 1075.0**

Check all quantities to insure net excavation is equal to the net embankment.  
 (excavation 1500.0 + (swell) 98.0 - (net embankment) 1075.0 - (waste) 523.0 = 0.0   
**Quantities Check**

## EARTHWORK CALCULATIONS PROJECT EXAMPLES

### PROJECT EXAMPLE NO. 1: Four-Lane Divided Roadway (New EB, Widened WB)

This sample project is based on a typical rural highway upgrade project converting a two-lane highway to four lanes with a natural median. This project includes the widening of the existing roadway to the design standard as well as adding right and left turn lanes. Roadway excavation includes a mix of shrink and swell factors. The computer modeling program computed the adjusted roadway excavation volumes to obtain an accurate mass haul ordinate.

However, since this project has more excavated material than embankment, the computer adjusted the waste material, also. Waste material does not have the shrink or swell factor applied, therefore the computer adjusted excavation quantities need to be adjusted. Where the shrink adjustment occurs is at the designer’s discretion based mainly on the proposed construction phasing and mass haul ordinates. The Roadway Excavation Shrink for the eastbound and westbound roadway were chosen as the values to correct since the drainage and channel excavation were proposed to be constructed first. Also, based on the proposed construction sequencing, the waste material was determined to be from the 10% shrink material. **Therefore, the adjusted waste value provided by the computer was divided by (1-Shr%) or 0.90.**

This project included upsizing the existing culverts, the new culverts through the existing roadway prism would be constructed in a trench condition. The existing culvert volume was ignored in the calculations for simplicity, but could be easily calculated. Pipes in trench condition do not displace any roadway embankment, however, additional embankment material must be provided for pipe and trench backfill and are calculated in the example.

| EARTHWORK QUANTITIES  |                  |                           |                    |                    |              |
|-----------------------|------------------|---------------------------|--------------------|--------------------|--------------|
|                       | <i>Eastbound</i> | <i>Combined Westbound</i> | <i>16th Street</i> | <i>24th Street</i> | <i>Total</i> |
| Roadway Excavation*   | 120,586 CY       | 25,143 CY                 | 1,727 CY           | 1,425 CY           | 148,881 CY   |
| Shrink                | 16,693 CY        | 5,962 CY                  | 106 CY             | 213 CY             | 22,974 CY    |
| Drainage Excavation   | 179 CY           | 146 CY                    | 0 CY               | 0 CY               | 325 CY       |
| Shrink                | 19 CY            | 15 CY                     | 0 CY               | 0 CY               | 34 CY        |
| Structural Excavation | 645 CY           | 2,875 CY                  | 0 CY               | 0 CY               | 3,520 CY     |
| Shrink                | 65 CY            | 287 CY                    | 0 CY               | 0 CY               | 352 CY       |
| Channel Excavation    | 18,347 CY        | 0 CY                      | 0 CY               | 0 CY               | 18,347 CY    |
| Shrink                | 1,835 CY         | 0 CY                      | 0 CY               | 0 CY               | 1,835 CY     |
| Pipe Excavation       | 251 CY           | 572 CY                    | 0 CY               | 0 CY               | 823 CY       |
| Shrink                | 28 CY            | 60 CY                     | 0 CY               | 0 CY               | 88 CY        |
|                       |                  | CY                        | CY                 | CY                 | CY           |
| Embankment+           | 116,344 CY       | 12,337 CY                 | 947 CY             | 489 CY             | 130,117 CY   |
| Structure Backfill    | 787 CY           | 1,248 CY                  | 0 CY               | 0 CY               | 2,035 CY     |
| Pipe Backfill         | 156 CY           | 146 CY                    | 0 CY               | 0 CY               | 302 CY       |
| Trench Backfill       | 0 CY             | 1,390 CY                  | 0 CY               | 0 CY               | 1,390 CY     |
| Waste                 | 4,081 CY         | 7,291 CY                  | 674 CY             | 723 CY             | 12,769 CY    |

\* Includes: turnout excavation

| EARTHWORK FACTORS   |        |       |                   |
|---------------------|--------|-------|-------------------|
| Station             | Shrink | Swell | Ground Compaction |
| EB 66+00 to 180+00  | 10 %   | %     | 0.10 '            |
| EB 108+00 to 132+00 | 20 %   | %     | 0.20 '            |
| WB 66+00 to 110+00  | 10 %   | %     | 0.10 '            |
| WB 110+00 to 124+00 | 20 %   | %     | 0.20 '            |
| WB 124+00 to 132+00 | 15 %   | %     | 0.10 '            |
| 16th 30+15 to 40+00 | 10 %   | %     | 0.10 '            |
| 24th 40+15 to 49+00 | 20 %   | %     | 0.20 '            |

+ Includes Ground Compaction, Turnout Embankment and Berms

EARTHWORK CALCULATIONS

Project Name: Sample Project  
 Project No.: \_\_\_\_\_  
 TRACS No.: 001 MA 026 H1111 01C

Date: 1/5/2002  
 Prepared By: abc  
 Checked By: xyz

| STA | CUT<br>ADJUST<br>FACTOR | CUT<br>AREA<br>(S.F.) | CUT<br>VOLUME<br>(C.Y.) | ADJUSTED<br>CUT<br>VOLUME<br>(C.Y.) | ACCUM<br>CUT<br>VOLUME<br>(C.Y.) | FILL<br>ADJUST<br>FACTOR | FILL<br>AREA<br>(S.F.) | FILL<br>VOLUME<br>(C.Y.) | ADJUSTED<br>FILL<br>VOLUME<br>(C.Y.) | ACCUM<br>FILL<br>VOLUME<br>(C.Y.) | MASS<br>HAUL<br>ORDINATE<br>(C.Y.) |
|-----|-------------------------|-----------------------|-------------------------|-------------------------------------|----------------------------------|--------------------------|------------------------|--------------------------|--------------------------------------|-----------------------------------|------------------------------------|
|-----|-------------------------|-----------------------|-------------------------|-------------------------------------|----------------------------------|--------------------------|------------------------|--------------------------|--------------------------------------|-----------------------------------|------------------------------------|

**SR 1 NEW EASTBOUND ROADWAY**

|               |     |          |                |                |          |      |         |                |                |        |        |
|---------------|-----|----------|----------------|----------------|----------|------|---------|----------------|----------------|--------|--------|
| 66+00         | 0.9 | 61.68    | 0              | 0              | 0        | 1.00 | 0       | 0              | 0              | 0      | 0      |
| 67+00         | 0.9 | 168.69   | 427            | 384.3          | 384.3    | 1.00 | 0       | 0              | 0              | 0      | 384    |
| 68+00         | 0.9 | 306.06   | 879            | 791.1          | 1175.4   | 1.00 | 0       | 0              | 0              | 0      | 1175   |
| 69+00         | 0.9 | 470.55   | 1438           | 1294.2         | 2469.6   | 1.00 | 0       | 0              | 0              | 0      | 2470   |
| 70+00         | 0.9 | 602.34   | 1987           | 1788.3         | 4257.9   | 1.00 | 0       | 0              | 0              | 0      | 4258   |
| 71+00         | 0.9 | 753.00   | 2510           | 2259           | 6516.9   | 1.00 | 0       | 0              | 0              | 0      | 6517   |
| 72+00         | 0.9 | 863.04   | 2993           | 2693.7         | 9210.6   | 1.00 | 0       | 0              | 0              | 0      | 9211   |
| 73+00         | 0.9 | 933.78   | 3327           | 2994.3         | 12204.9  | 1.00 | 0       | 0              | 0              | 0      | 12205  |
| 74+00         | 0.9 | 1,060.83 | 3694           | 3324.6         | 15529.5  | 1.00 | 0       | 0              | 0              | 0      | 15530  |
| 74+36         | 0.9 | 1,122.66 | 1456           | 1310.4         | 16839.9  | 1.00 | 0       | 0              | 0              | 0      | 16840  |
| 75+00         | 0.9 | 902.46   | 2400           | 2160           | 18999.9  | 1.00 | 0       | 0              | 0              | 0      | 19000  |
| 76+00         | 0.9 | 864.33   | 3272           | 2944.8         | 21944.7  | 1.00 | 0       | 0              | 0              | 0      | 21945  |
| 77+00         | 0.9 | 792.93   | 3069           | 2762.1         | 24706.8  | 1.00 | 0       | 0              | 0              | 0      | 24707  |
| 78+00         | 0.9 | 698.64   | 2762           | 2485.8         | 27192.6  | 1.00 | 71.7    | 133            | 133            | 133    | 27060  |
| 79+00         | 0.9 | 522.99   | 2262           | 2035.8         | 29228.4  | 1.00 | 259.62  | 614            | 614            | 747    | 28481  |
| 80+00         | 0.9 | 483.60   | 1864           | 1677.6         | 30906    | 1.00 | 423.63  | 1265           | 1265           | 2012   | 28894  |
| 81+00         | 0.9 | 370.38   | 1581           | 1422.9         | 32328.9  | 1.00 | 762.9   | 2197           | 2197           | 4209   | 28120  |
| 82+00         | 0.9 | 162.63   | 987            | 888.3          | 33217.2  | 1.00 | 936.75  | 3148           | 3148           | 7357   | 25860  |
| 83+00         | 0.9 | 0.00     | 301            | 270.9          | 33488.1  | 1.00 | 1137.75 | 3842           | 3842           | 11199  | 22289  |
| 83+62         | 0.9 | 0.00     | 0              | 0              | 33488.1  | 1.00 | 1370.34 | 2880           | 2880           | 14079  | 19409  |
| 84+00         | 0.9 | 0.00     | 0              | 0              | 33488.1  | 1.00 | 1287.57 | 1870           | 1870           | 15949  | 17539  |
| ..            |     |          |                |                |          |      |         |                |                |        |        |
| 123+00        | 0.8 | 1,761.90 | 5847           | 4677.6         | 79702.2  | 1.00 | 0       | 0              | 0              | 109236 | -29534 |
| 123+67        | 0.8 | 1,957.02 | 4614           | 3691.2         | 83393.4  | 1.00 | 0       | 0              | 0              | 109236 | -25843 |
| 124+00        | 0.8 | 1,877.22 | 2343           | 1874.4         | 85267.8  | 1.00 | 0       | 0              | 0              | 109236 | -23968 |
| 125+00        | 0.8 | 1,678.86 | 6585           | 5268           | 90535.8  | 1.00 | 0       | 0              | 0              | 109236 | -18700 |
| 126+00        | 0.8 | 1,257.75 | 5438           | 4350.4         | 94886.2  | 1.00 | 0       | 0              | 0              | 109236 | -14350 |
| 127+00        | 0.8 | 1,071.06 | 4313           | 3450.4         | 98336.6  | 1.00 | 30.6    | 57             | 57             | 109293 | -10956 |
| 128+00        | 0.8 | 687.63   | 3257           | 2605.6         | 100942.2 | 1.00 | 169.35  | 370            | 370            | 109663 | -8721  |
| 129+00        | 0.8 | 364.62   | 1949           | 1559.2         | 102501.4 | 1.00 | 337.35  | 938            | 938            | 110601 | -8100  |
| 130+00        | 0.8 | 70.35    | 806            | 644.8          | 103146.2 | 1.00 | 569.1   | 1679           | 1679           | 112280 | -9134  |
| 131+00        | 0.8 | 0.00     | 130            | 104            | 103250.2 | 1.00 | 668.64  | 2292           | 2292           | 114572 | -11322 |
| 132+00        | 0.8 | 0.00     | 0              | 0              | 103250.2 | 1.00 | 540.69  | 2240           | 2240           | 116812 | -13562 |
| <b>TOTALS</b> |     |          | <b>120,325</b> | <b>103,250</b> |          |      |         | <b>116,812</b> | <b>116,812</b> |        |        |

PROJECT EXAMPLE NO. 1  
2 of 10

EARTHWORK CALCULATIONS

Project Name: Sample Project  
 Project No.: \_\_\_\_\_  
 TRACS No.: 001 MA 026 H1111 01C

Date: 1/5/2002  
 Prepared By: abc  
 Checked By: xyz

| STA | CUT<br>ADJUST<br>FACTOR | CUT<br>AREA<br>(S.F.) | CUT<br>VOLUME<br>(C.F.) | ADJUSTED<br>CUT<br>VOLUME<br>(C.Y.) | ACCUM<br>CUT<br>VOLUME<br>(C.Y.) | FILL<br>ADJUST<br>FACTOR | FILL<br>AREA<br>(S.F.) | FILL<br>VOLUME<br>(C.F.) | ADJUSTED<br>FILL<br>VOLUME<br>(C.F.) | ACCUM<br>FILL<br>VOLUME<br>(C.F.) | MASS<br>HAUL<br>ORDINATE<br>(C.Y.) |
|-----|-------------------------|-----------------------|-------------------------|-------------------------------------|----------------------------------|--------------------------|------------------------|--------------------------|--------------------------------------|-----------------------------------|------------------------------------|
|-----|-------------------------|-----------------------|-------------------------|-------------------------------------|----------------------------------|--------------------------|------------------------|--------------------------|--------------------------------------|-----------------------------------|------------------------------------|

**SR 1 WESTBOUND ROADWAY - INSIDE MEDIAN OR WIDENING FOR LEFT TURN LANE**

|               |      |       |               |              |         |      |       |             |             |      |      |
|---------------|------|-------|---------------|--------------|---------|------|-------|-------------|-------------|------|------|
| 69+00         | 0.9  | 31.26 | 3994          | 0            | 0       | 1.00 | 0     | 0           | 0           | 0    | 0    |
| 70+00         | 0.9  | 36.96 | 126           | 113.4        | 113.4   | 1.00 | 0     | 0           | 0           | 0    | 113  |
| 123+00        | 0.8  | 15.30 | 60            | 48           | 8525.2  | 1.00 | 21.99 | 94          | 94          | 5988 | 2537 |
| 124+00        | 0.8  | 15.30 | 57            | 45.6         | 8570.8  | 1.00 | 25.65 | 88          | 88          | 6076 | 2495 |
| 125+00        | 0.85 | 15.30 | 57            | 48.45        | 8619.25 | 1.00 | 27.63 | 99          | 99          | 6175 | 2444 |
| 126+00        | 0.85 | 15.63 | 57            | 48.45        | 8667.7  | 1.00 | 29.61 | 106         | 106         | 6281 | 2387 |
| 127+00        | 0.85 | 15.36 | 57            | 48.45        | 8716.15 | 1.00 | 41.52 | 132         | 132         | 6413 | 2303 |
| 128+00        | 0.85 | 15.39 | 57            | 48.45        | 8764.6  | 1.00 | 44.43 | 159         | 159         | 6572 | 2193 |
| ...           |      |       |               |              |         |      |       |             |             |      |      |
| 129+00        | 0.85 | 15.30 | 57            | 48.45        | 8813.05 | 1.00 | 47.34 | 170         | 170         | 6742 | 2071 |
| 129+48        | 0.85 | 15.30 | 27            | 22.95        | 8836    | 1.00 | 49.02 | 86          | 86          | 6828 | 2008 |
| 130+00        | 0.85 | 15.27 | 29            | 24.65        | 8860.65 | 1.00 | 47.94 | 93          | 93          | 6921 | 1940 |
| 131+00        | 0.85 | 9.36  | 46            | 39.1         | 8899.75 | 1.00 | 15.66 | 118         | 118         | 7039 | 1861 |
| 132+00        | 0.85 | 5.94  | 28            | 23.8         | 8923.55 | 1.00 | 0     | 29          | 29          | 7068 | 1856 |
| <b>TOTALS</b> |      |       | <b>14,223</b> | <b>8,924</b> |         |      |       | <b>7068</b> | <b>7068</b> |      |      |

**SR 1 WESTBOUND OUTSIDE SHOULDER AND RIGHT TURN LANE WIDENING**

|                                |      |        |               |               |         |      |       |               |               |      |      |
|--------------------------------|------|--------|---------------|---------------|---------|------|-------|---------------|---------------|------|------|
| 69+00                          | 0.9  | 0.00   | 0             | 0             | 0       | 1.00 | 0     | 0             | 0             | 0    | 0    |
| 70+00                          | 0.9  | 7.68   | 14            | 12.6          | 12.6    | 1.00 | 0     | 0             | 0             | 0    | 13   |
| 71+00                          | 0.9  | 37.68  | 84            | 75.6          | 88.2    | 1.00 | 0     | 0             | 0             | 0    | 88   |
| 72+00                          | 0.9  | 76.08  | 211           | 189.9         | 278.1   | 1.00 | 0     | 0             | 0             | 0    | 278  |
| 73+00                          | 0.9  | 97.95  | 322           | 289.8         | 567.9   | 1.00 | 0     | 0             | 0             | 0    | 568  |
| 74+00                          | 0.9  | 106.26 | 378           | 340.2         | 908.1   | 1.00 | 0     | 0             | 0             | 0    | 908  |
| 74+25                          | 0.9  | 108.75 | 100           | 90            | 998.1   | 1.00 | 0     | 0             | 0             | 0    | 998  |
| 75+00                          | 0.9  | 93.06  | 280           | 252           | 1250.1  | 1.00 | 0     | 0             | 0             | 0    | 1250 |
| ...                            |      |        |               |               |         |      |       |               |               |      |      |
| 129+00                         | 0.85 | 7.41   | 110           | 93.5          | 9255    | 1.00 | 16.35 | 30            | 30            | 4090 | 5165 |
| 129+48                         | 0.85 | 51.69  | 53            | 45.05         | 9300.05 | 1.00 | 7.95  | 22            | 22            | 4112 | 5188 |
| 130+00                         | 0.85 | 47.97  | 96            | 81.6          | 9381.65 | 1.00 | 0     | 8             | 8             | 4120 | 5262 |
| 131+00                         | 0.85 | 8.97   | 105           | 89.25         | 9470.9  | 1.00 | 5.91  | 11            | 11            | 4131 | 5340 |
| 132+00                         | 0.85 | 16.47  | 47            | 39.95         | 9510.85 | 1.00 | 0     | 11            | 11            | 4142 | 5369 |
| <b>TOTALS</b>                  |      |        | <b>10,898</b> | <b>9,511</b>  |         |      |       | <b>4142</b>   | <b>4142</b>   |      |      |
| <b>TOTAL WESTBOUND ROADWAY</b> |      |        | <b>25,121</b> | <b>18,434</b> |         |      |       | <b>11,210</b> | <b>11,210</b> |      |      |

EARTHWORK CALCULATIONS

Project Name: Sample Project  
 Project No.: \_\_\_\_\_  
 TRACS No.: 001 MA 026 H1111 01C

Date: 1/5/2002  
 Prepared By: abc  
 Checked By: xyz

| STA | CUT ADJUST FACTOR | CUT AREA (S.F.) | CUT VOLUME (C.F.) | ADJUSTED CUT VOLUME (C.Y.) | ACCUM CUT VOLUME (C.Y.) | FILL ADJUST FACTOR | FILL AREA (S.F.) | FILL VOLUME (C.F.) | ADJUSTED FILL VOLUME (C.F.) | ACCUM FILL VOLUME (C.F.) | MASS HAUL ORDINATE (C.Y.) |
|-----|-------------------|-----------------|-------------------|----------------------------|-------------------------|--------------------|------------------|--------------------|-----------------------------|--------------------------|---------------------------|
|-----|-------------------|-----------------|-------------------|----------------------------|-------------------------|--------------------|------------------|--------------------|-----------------------------|--------------------------|---------------------------|

**16TH STREET RECONSTRUCTION**

|               |     |        |              |              |        |      |       |            |            |     |      |
|---------------|-----|--------|--------------|--------------|--------|------|-------|------------|------------|-----|------|
| 30+15         | 0.9 | 0.00   | 0            | 0            | 0      | 1.00 | 0     | 0          | 0          | 0   | 0    |
| 31+00         | 0.9 | 89.13  | 140          | 126          | 126    | 1.00 | 0     | 0          | 0          | 0   | 126  |
| 32+00         | 0.9 | 116.17 | 380          | 342          | 468    | 1.00 | 0     | 0          | 0          | 0   | 468  |
| 33+00         | 0.9 | 102.35 | 405          | 364.5        | 832.5  | 1.00 | 0     | 0          | 0          | 0   | 833  |
| 34+00         | 0.9 | 60.31  | 301          | 270.9        | 1103.4 | 1.00 | 0     | 0          | 0          | 0   | 1103 |
| 35+00         | 0.9 | 30.00  | 167          | 150.3        | 1253.7 | 1.00 | 17.76 | 33         | 33         | 33  | 1221 |
| 36+00         | 0.9 | 21.81  | 96           | 86.4         | 1340.1 | 1.00 | 20.58 | 71         | 71         | 104 | 1236 |
| 37+00         | 0.9 | 27.04  | 90           | 81           | 1421.1 | 1.00 | 73.68 | 175        | 175        | 279 | 1142 |
| 38+00         | 0.9 | 26.65  | 99           | 89.1         | 1510.2 | 1.00 | 70.38 | 267        | 267        | 546 | 964  |
| 39+00         | 0.9 | 0.00   | 49           | 44.1         | 1554.3 | 1.00 | 49.62 | 222        | 222        | 768 | 786  |
| 40+00         | 0.9 | 0.00   | 0            | 0            | 1554.3 | 1.00 | 36.93 | 160        | 160        | 928 | 626  |
| <b>TOTALS</b> |     |        | <b>1,727</b> | <b>1,554</b> |        |      |       | <b>928</b> | <b>928</b> |     |      |

**24TH STREET WIDENING**

|               |     |       |              |              |        |      |       |            |            |     |     |
|---------------|-----|-------|--------------|--------------|--------|------|-------|------------|------------|-----|-----|
| 40+15         | 0.8 | 54.88 | 0            | 0            | 0      | 1.00 | 0     | 0          | 0          | 0   | 0   |
| 41+00         | 0.8 | 63.76 | 187          | 149.6        | 149.6  | 1.00 | 0     | 0          | 0          | 0   | 150 |
| 42+00         | 0.8 | 66.62 | 241          | 192.8        | 342.4  | 1.00 | 9.78  | 18         | 18         | 18  | 324 |
| 43+00         | 0.8 | 56.75 | 228          | 182.4        | 524.8  | 1.00 | 16.86 | 49         | 49         | 67  | 458 |
| 44+00         | 0.8 | 58.83 | 214          | 171.2        | 696    | 1.00 | 6.96  | 44         | 44         | 111 | 585 |
| 45+00         | 0.8 | 47.77 | 197          | 157.6        | 853.6  | 1.00 | 3.75  | 20         | 20         | 131 | 723 |
| 46+00         | 0.8 | 38.79 | 160          | 128          | 981.6  | 1.00 | 16.68 | 38         | 38         | 169 | 813 |
| 47+00         | 0.8 | 34.25 | 135          | 108          | 1089.6 | 1.00 | 24.72 | 77         | 77         | 246 | 844 |
| 48+00         | 0.8 | 0.00  | 63           | 50.4         | 1140   | 1.00 | 37.02 | 114        | 114        | 360 | 780 |
| 49+00         | 0.8 | 0.00  | 0            | 0            | 1140   | 1.00 | 24.63 | 114        | 114        | 474 | 666 |
| <b>TOTALS</b> |     |       | <b>1,425</b> | <b>1,140</b> |        |      |       | <b>474</b> | <b>474</b> |     |     |

**TOTAL ROADWAY EXCAVATION (computer) RX = 148,598 Does not include Structural, Pipe, Drainage and Miscellaneous Excavation**

**TOTAL ADJUSTED ROADWAY EXCAVATION (computer) 124,379 Skrink Factor is Applied to All Roadway Excavation, including waste**

**TOTAL ROADWAY EMBANKMENT (computer) RM = 129,459 Does not include adjustments for Ground Compaction, Pipe Backfill, Trench Backfill, Culvert Quantity Adjustment, Structure Backfill and Turnout Embankment**

EARTHWORK CALCULATIONS

Project Name: Sample Project  
 Project No.: \_\_\_\_\_  
 TRACS No.: 001 MA 026 H1111 01C

Date: 1/5/2002  
 Prepared By: abc  
 Checked By: xyz

| STA | CUT<br>ADJUST<br>FACTOR | CUT<br>AREA<br>(S.F.) | CUT<br>VOLUME<br>(C.F.) | ADJUSTED<br>CUT<br>VOLUME<br>(C.Y.) | ACCUM<br>CUT<br>VOLUME<br>(C.Y.) | FILL<br>ADJUST<br>FACTOR | FILL<br>AREA<br>(S.F.) | FILL<br>VOLUME<br>(C.F.) | ADJUSTED<br>FILL<br>VOLUME<br>(C.F.) | ACCUM<br>FILL<br>VOLUME<br>(C.F.) | MASS<br>HAUL<br>ORDINATE<br>(C.Y.) |
|-----|-------------------------|-----------------------|-------------------------|-------------------------------------|----------------------------------|--------------------------|------------------------|--------------------------|--------------------------------------|-----------------------------------|------------------------------------|
|-----|-------------------------|-----------------------|-------------------------|-------------------------------------|----------------------------------|--------------------------|------------------------|--------------------------|--------------------------------------|-----------------------------------|------------------------------------|

CHANNEL

|               |     |        |               |               |         |      |      |           |           |    |       |
|---------------|-----|--------|---------------|---------------|---------|------|------|-----------|-----------|----|-------|
| 114+11        | 0.9 | 0.00   | 0             | 0             | 0       | 1.00 | 0    | 0         | 0         | 0  | 0     |
| 115+00        | 0.9 | 45.50  | 75            | 67.5          | 67.5    | 1.00 | 2.58 | 4         | 4         | 4  | 64    |
| 116+00        | 0.9 | 89.82  | 251           | 225.9         | 293.4   | 1.00 | 2.94 | 10        | 10        | 14 | 279   |
| 117+00        | 0.9 | 102.75 | 357           | 321.3         | 614.7   | 1.00 | 0.96 | 7         | 7         | 21 | 594   |
| 118+00        | 0.9 | 229.77 | 616           | 554.4         | 1169.1  | 1.00 | 0    | 2         | 2         | 23 | 1146  |
| 119+00        | 0.9 | 258.78 | 905           | 814.5         | 1983.6  | 1.00 | 0    | 0         | 0         | 23 | 1961  |
| 120+00        | 0.9 | 254.34 | 950           | 855           | 2838.6  | 1.00 | 0    | 0         | 0         | 23 | 2816  |
| 121+00        | 0.9 | 240.72 | 917           | 825.3         | 3663.9  | 1.00 | 0    | 0         | 0         | 23 | 3641  |
| 122+00        | 0.9 | 230.97 | 874           | 786.6         | 4450.5  | 1.00 | 0    | 0         | 0         | 23 | 4428  |
| 123+00        | 0.9 | 211.71 | 820           | 738           | 5188.5  | 1.00 | 0    | 0         | 0         | 23 | 5166  |
| 124+00        | 0.9 | 243.69 | 843           | 758.7         | 5947.2  | 1.00 | 0    | 0         | 0         | 23 | 5924  |
| 125+00        | 0.9 | 265.32 | 943           | 848.7         | 6795.9  | 1.00 | 0    | 0         | 0         | 23 | 6773  |
| 126+00        | 0.9 | 255.84 | 965           | 868.5         | 7664.4  | 1.00 | 0    | 0         | 0         | 23 | 7641  |
| 127+00        | 0.9 | 254.34 | 945           | 850.5         | 8514.9  | 1.00 | 0    | 0         | 0         | 23 | 8492  |
| 128+00        | 0.9 | 247.83 | 930           | 837           | 9351.9  | 1.00 | 0    | 0         | 0         | 23 | 9329  |
| 129+00        | 0.9 | 277.14 | 972           | 874.8         | 10226.7 | 1.00 | 0    | 0         | 0         | 23 | 10204 |
| 130+00        | 0.9 | 305.28 | 1079          | 971.1         | 11197.8 | 1.00 | 0    | 0         | 0         | 23 | 11175 |
| 131+00        | 0.9 | 265.89 | 1058          | 952.2         | 12150   | 1.00 | 0    | 0         | 0         | 23 | 12127 |
| 132+00        | 0.9 | 257.01 | 968           | 871.2         | 13021.2 | 1.00 | 0    | 0         | 0         | 23 | 12998 |
| 133+00        | 0.9 | 224.16 | 891           | 801.9         | 13823.1 | 1.00 | 0    | 0         | 0         | 23 | 13800 |
| 134+00        | 0.9 | 239.25 | 858           | 772.2         | 14595.3 | 1.00 | 0    | 0         | 0         | 23 | 14572 |
| 135+00        | 0.9 | 183.00 | 782           | 703.8         | 15299.1 | 1.00 | 0.99 | 2         | 2         | 25 | 15274 |
| 136+00        | 0.9 | 227.40 | 760           | 684           | 15983.1 | 1.00 | 0    | 2         | 2         | 27 | 15956 |
| 137+00        | 0.9 | 26.94  | 471           | 423.9         | 16407   | 1.00 | 2.25 | 4         | 4         | 31 | 16376 |
| 138+00        | 0.9 | 23.40  | 93            | 83.7          | 16490.7 | 1.00 | 0    | 4         | 4         | 35 | 16456 |
| 138+55        | 0.9 | 0.00   | 24            | 21.6          | 16512.3 | 1.00 | 0    | 0         | 0         | 35 | 16477 |
| <b>TOTALS</b> |     |        | <b>18,347</b> | <b>16,512</b> |         |      |      | <b>35</b> | <b>35</b> |    |       |

TOTAL CHANNEL EXCAVATION (computer) CX = 18,347

TOTAL ADJUSTED CHANNEL EXCAVATION (computer) 16,512

EARTHWORK CALCULATIONS

Project Name: Sample Project  
 Project No.: \_\_\_\_\_  
 TRACS No.: 001 MA 026 H1111 01C

Date: 1/5/2002  
 Prepared By: abc  
 Checked By: xyz

**Box Culvert Quantity Adjustments**

| Dir.        | Station | Ref No. | Size             | Maximum Box Width | Maximum Box Height | Trench Length | Ave Trench Depth | Trench Width | Structural Excavation Volume | Structure Backfill Volume | Culvert Volume | Trench Backfill Volume | Culvert Adjustment | Drainage Excavation |
|-------------|---------|---------|------------------|-------------------|--------------------|---------------|------------------|--------------|------------------------------|---------------------------|----------------|------------------------|--------------------|---------------------|
|             |         |         |                  | A (ft)            | C (ft)             |               | B (ft)           | H (ft)       | W (ft)                       | SX (cu.yd.)               | SB (cu.yd.)    | CV (cu.yd.)            | RB (cu.yd.)        | CA (cu.yd.)         |
| EB          | 104+54  | 1       | 2-12'x8'x120'    | 27.25             | 10.25              | 161           | 3.50             | 30.91        | 645                          | 787                       | 1,666          | na                     | -1,807             | 121                 |
| WB          | 104+25  | 2       | 2-12'x8'x102'-6" | 27.25             | 10.25              | 143.5         | 17.50            | 30.91        | 2,875                        | 1,248                     | 1,484          | 1,191                  | 0                  | 102                 |
| Page Totals |         |         |                  |                   |                    |               |                  |              | <b>3,520</b>                 | <b>2,035</b>              |                |                        | <b>-1,807</b>      | <b>223</b>          |

Notes:

- Maximum Box Height and Width correspond to the maximum "H" and "T" used in the box in accordance with ADOT Std. B-02.nn or detail.
- Trench Length (B) = Culvert Length + 2C + 2C as shown in ADOT Standards or detail
- Trench Width (W) = A + 2 x (4/12) + 2 x 1.5 for soil conditions  
 = A + 2 x (4/12) + 2 x 0.5 for rock trench conditions  
 note: 4/12 accounts for bottom slab extending 4" beyond outside of walls
- Str. Exc = W x H x B / 27
- Structure Backfill from ADOT Std. B-19.50  
 (1.83' = distance from outside wall of box to toe of slope in soil conditions)  
 (0.83' = distance from outside wall of box to toe of slope in rock conditions)  

$$\text{Str Bkfl} = 2 \times [C \times (C-H) + H \times 1.83] \times (B - 2C) / 27$$
 for non trench in soil  

$$2 \times [C \times (C-H) + H \times 0.83] \times (B - 2C) / 27$$
 for non trench in rock  

$$2 \times [(1.83 \times C) + (0.5 \times C \times 1.5 \times C)] \times (B - 2C) / 27$$
 for trench in soil  

$$2 \times [(0.83 \times C) + (0.5 \times C \times 1.5 \times C)] \times (B - 2C) / 27$$
 for trench in rock
- Culvert Volume (CV) = A x C x B / 27
- Trench Backfill = 0 if C >= H  
 = (H-C) x W x B / 27 if C < H
- Trench Backfill is the additional volume of material required above the box to meet natural ground. This volume is added to the Total Embankment.
- Culvert Adjustment is the volume of embankment displaced by the culvert and structure backfill roadway embankment  

$$CA = SX - (CV + SB), CA \leq 0$$
  
 Negative number indicates roadway embankment being displaced by culvert and Structure Backfill  
 Positive number indicates additional embankment required to fill over the culvert and the Adjustment is 0 cy.
- Drainage excavation includes excavation for ditches and outlet protection.

EARTHWORK CALCULATIONS

Project Name: Sample Project  
 Project No.: \_\_\_\_\_  
 TRACS No.: 001 MA 026 H1111 01C

Date: 01/05/2002  
 Prepared By: abc  
 Checked By: xyz

Pipe Quantity Calculations

| Dir. | Station | Ref No.   | Pipe Size | No. of Pipes | Net Pipe Length | Average Trench Depth | Pipe Spacing cl-cl | Trench Width     | Pipe Excavatio Volume | Pipe Bedding Volume | Pipe Backfill Volume | Bedding+ Backfill+ Pipe Volume | Pipe Culvert Volume | Culvert Adjustment | Trench Backfill Volume | Drainage Excavation |
|------|---------|---|-----------|--------------|-----------------|----------------------|--------------------|------------------|-----------------------|---------------------|----------------------|--------------------------------|---------------------|--------------------|------------------------|---------------------|
|      |         |  | D (in)    | N            | L (ft)          | H (ft)               | S (ft)             | W (ft)           | PX (cu.yd.)           | Bed (cu.yd.)        | PB (cu.yd.)          | PD (cu.yd.)                    | CV (cu.yd.)         | CA (cu.yd.)        | TB (cu.yd.)            | DX (cu.yd.)         |
| EB   | ###     | 1   | 48        | 2            | 124             | 3.00                 | 7.00               | 14.00            | 225                   | 103                 | 135                  | 354                            | 115                 | -129               | 0                      | 48                  |
| EB   | ###     | 3   | 24        | 1            | 88              | 1.50                 |                    | 4.00             | 26                    | 14                  | 21                   | 46                             | 10                  | -20                | 0                      | 10                  |
|      |         |   |           |              |                 |                      |                    | <b>EB Totals</b> | <b>251</b>            |                     | <b>156</b>           |                                |                     | <b>-148</b>        | <b>0</b>               | <b>58</b>           |
| WB   | ###     | 2   | 48        | 2            | 116             | 8.00                 | 7.00               | 14.00            | 511                   | 96                  | 126                  | 331                            | 108                 | 0                  | 180                    | 36                  |
| WB   | ###     | 4   | 24        | 1            | 82              | 4.50                 |                    | 4.00             | 61                    | 13                  | 20                   | 43                             | 10                  | 0                  | 18                     | 8                   |
|      |         |   |           |              |                 |                      |                    | <b>WB Totals</b> | <b>572</b>            |                     | <b>146</b>           |                                |                     | <b>0</b>           | <b>199</b>             | <b>44</b>           |

Notes:

- Pipe backfill quantities are based on ADOT Std C-13.15 for Trench Condition
- Pipe excavation is based on ADOT Std. C-13.15 for Trench Condition with Bracing
- K = 2 ft for D<48", 3 ft for D>= 48"
- Trench Width (W) = D/12+K+(N-1)\*S
- For S, See ADOT Std. C-13.10 or Plans
- Pipe Length (L) includes Pipe Length plus 2 x D to account for headwalls and/or end sections, if applicable
- CA = PX - (CV + Bed + PB), CA <=0  
 CA < 0, indicates roadway embankment displaced by pipe culvert installation  
 CA = 0, Full Trench Condition where no roadway embankment displacement occurs

- Pipe Exc (PX) = Exc. Depth x W x L  
 Pipe Bedding (Bed) = (D/2/12 + 0.5) x W x L - CV /2  
 Pipe Backfill (PB) = (D/2/12 + 1.0) x W x L - CV /2  
 Exc. Depth = H + 0.5  
 Trench Backfill (TB) = 0 if H < D/12  
 = Pipe Exc - Bedding - Pipe Backfill - Pipe Volume  
 Pipe Volume (CV) = N x pi x (D/2)<sup>2</sup> x L  
 Culvert Adjustment (CA) indicates the amount of roadway embankment material displaced by the pipe culvert, pipe bedding and pipe backfill.

Note: For use in formulas, D is in ft.

Miscellaneous Earthwork  
 Turnout Earthwork Summary

| Dir. | urnot | Lt/Rt | Station       | Excavation TX (cu.yd.) | Embank. MM (cu.yd.) | Shr (-%) Swl(+%) (%) | Shrink/Swell (cu.yd.) |
|------|-------|-------|---------------|------------------------|---------------------|----------------------|-----------------------|
| EB   | Priva | Rt    | 6940          | 2                      | 124                 | -10%                 | 0                     |
| EB   | Rand  | Rt    | 11434         | 259                    | 0                   | -10%                 | -26                   |
|      |       |       | <b>EB TOT</b> | <b>261</b>             | <b>124</b>          |                      | <b>-26</b>            |
| WB   | Chur  | Lt    | 7489          | 22                     | 197                 | -20%                 | -4                    |
| WB   | Well  | Lt    | 13088         | 0                      | 204                 | -15%                 | 0                     |
|      |       |       | <b>WB TOT</b> | <b>22</b>              | <b>401</b>          |                      | <b>-4</b>             |

Notes:

- Shrink = Cut Volume x Shr%
- Shr% is obtained from project materials report

EARTHWORK CALCULATIONS

Project Name: Sample Project  
 Project No.: \_\_\_\_\_  
 TRACS No.: 001 MA 026 H1111 01C

Date: 1/5/2002  
 Prepared By: abc  
 Checked By: xyz

**Excavation Adjustments**

The following table presents the shrink/swell calculations for the Channel, Drainage, Structural, and Pipe excavation. Miscellaneous excavation adjustments calculations are presented in the Miscellaneous Excavation Table. Roadway Excavation adjustments are calculated in the Summary Table.

| ID               | Station   |           | Station | Excavation CX (cy) | Embankment CM (cy) | Shr (-%) Swl (+%) | Shr/Swl | TOTALS |
|------------------|-----------|-----------|---------|--------------------|--------------------|-------------------|---------|--------|
| <b>Channel 1</b> | 114+11    | to        | 138+55  | 18,347             | 35                 | -10%              | -1835   | -1835  |
| <b>Structure</b> | 1         | EB        | 104+54  | 645                |                    | -10%              | -65     | -65    |
|                  | 2         | WB        | 104+25  | 2,875              |                    | -10%              | -287    | -287   |
| <b>Pipe</b>      | 1         | EB        | 83+75   | 225                |                    | -10%              | -23     |        |
|                  | 3         | EB        | 131+10  | 26                 |                    | -20%              | -5      | -28    |
|                  | 2         | WB        | 83+94   | 511                |                    | -10%              | -51     |        |
|                  | 4         | WB        | 130+96  | 61                 |                    | -15%              | -9      | -60    |
| <b>Drainage</b>  |           | <b>EB</b> | 104+54  | 121                |                    | -10%              | -12     |        |
|                  |           | <b>EB</b> | 83+73   | 48                 |                    | -10%              | -5      |        |
|                  |           | <b>EB</b> | 131+10  | 10                 |                    | -20%              | -2      | -19    |
|                  |           | <b>WB</b> | 104+25  | 102                |                    | -10%              | -10     |        |
|                  |           | <b>WB</b> | 83+94   | 36                 |                    | -10%              | -4      |        |
|                  | <b>WB</b> | 130+96    | 8       |                    | -15%               | -1                | -15     |        |

Notes:

- Assume all Channel Excavation is used for Roadway Embankment  
 $Shr = Cut Volume \times Shr (-\%)$

**Ground Compaction Summary**

| Dir/Road                       | Station |    | Station | Gnd Comp GC (cy) |
|--------------------------------|---------|----|---------|------------------|
| EB                             | 6600    | to | 13200   | 1,324            |
| WB                             | 6900    | to | 13200   | 726              |
| Turnouts                       |         |    |         | 4                |
| 16th                           | 3015    | to | 4000    | 19               |
| 24th                           | 4015    | to | 4900    | 15               |
| <b>TOTAL GROUND COMPACTION</b> |         |    |         | <b>2,088</b>     |

**Ground Compaction Factors**

| Dir/Road | Station | Station | Gnd Comp Factor (ft) |
|----------|---------|---------|----------------------|
| EB       | 6600    | 10800   | 0.10                 |
| EB       | 10800   | 13200   | 0.20                 |
| WB       | 6900    | 11000   | 0.10                 |
| WB       | 11000   | 12400   | 0.20                 |
| WB       | 12400   | 13200   | 0.10                 |
| 16th     | 3015    | 4000    | 0.10                 |
| 24th     | 4015    | 4900    | 0.20                 |
| Turnouts |         |         | 0.20                 |

Notes:

- Gnd Compaction factor is obtained from materials design report
- Gnd Comp Volume = Horizontal area of roadway embankment x Gnd Comp in cubic yards

EARTHWORK CALCULATIONS

Project Name: Sample Project  
 Project No.: \_\_\_\_\_  
 TRACS No.: 001 MA 026 H1111 01C

Date: 1/5/2002  
 Prepared By: abc  
 Checked By: xyz

**Ground Compaction Calculation Table**

| Station | Length of Fill on X-section (ft) | Length of Fill on X-section Lt (ft) | Length of Fill on X-section Rt (ft) | Fill Area (sq ft) | Ground Compaction Factor (ft) | Ground Compaction Volume (cu yd) |
|---------|----------------------------------|-------------------------------------|-------------------------------------|-------------------|-------------------------------|----------------------------------|
|---------|----------------------------------|-------------------------------------|-------------------------------------|-------------------|-------------------------------|----------------------------------|

**SR 74 NEW EASTBOUND ROADWAY**

|       |    |  |  |      |     |    |
|-------|----|--|--|------|-----|----|
| 8000  | 73 |  |  | 7050 | 0.1 | 26 |
| 8100  | 82 |  |  | 7750 | 0.1 | 29 |
| 8200  | 87 |  |  | 8450 | 0.1 | 31 |
| 8300  | 91 |  |  | 8900 | 0.1 | 33 |
| 8400  | 96 |  |  | 9350 | 0.1 | 35 |
| .     |    |  |  |      |     |    |
| .     |    |  |  |      |     |    |
| .     |    |  |  |      |     |    |
| 12800 | 68 |  |  | 6700 | 0.2 | 50 |
| 12900 | 75 |  |  | 7150 | 0.2 | 53 |
| 13000 | 86 |  |  | 8050 | 0.2 | 60 |
| 13100 | 90 |  |  | 8800 | 0.2 | 65 |
| 13200 | 82 |  |  | 8600 | 0.2 | 64 |

**TOTAL GROUND COMPACTION EB ROADWAY**

**1324**

**SR 74 WESTBOUND ROADWAY - Both Sides**

|       |    |    |    |      |     |    |
|-------|----|----|----|------|-----|----|
| 8300  | 50 | 21 | 29 | 4800 | 0.1 | 18 |
| 8400  | 46 | 19 | 27 | 4800 | 0.1 | 18 |
| 8500  | 41 | 17 | 24 | 4350 | 0.1 | 16 |
| 8600  | 35 | 15 | 20 | 3800 | 0.1 | 14 |
| 8700  | 0  | 0  | 0  | 1750 | 0.1 | 6  |
| .     |    |    |    |      |     |    |
| .     |    |    |    |      |     |    |
| .     |    |    |    |      |     |    |
| 12800 | 25 | 12 | 13 | 2450 | 0.1 | 9  |
| 12900 | 29 | 13 | 16 | 2700 | 0.1 | 10 |
| 13000 | 35 | 15 | 20 | 3200 | 0.1 | 12 |
| 13100 | 33 | 14 | 19 | 3400 | 0.1 | 13 |
| 13200 | 27 | 12 | 15 | 3000 | 0.1 | 11 |

**TOTAL GROUND COMPACTION WB ROADWAY**

**726**

EARTHWORK CALCULATIONS  
 Project Name: Sample Project  
 Project No.: \_\_\_\_\_  
 TRACS No.: 001 MA 026 H1111 01C

Date: 01/05/2002  
 Prepared By: abc  
 Checked By: xyz

## EARTHWORK CALCULATION SUMMARY TABLE

|  | Variable  | Eastbound        | Westbound       | 16th St.       | 24th St.       | Total            |
|--|-----------|------------------|-----------------|----------------|----------------|------------------|
| Roadway Excavation                     | <b>RX</b> | 120,325.0        | 25,121.0        | 1,727.0        | 1,425.0        | 148,598.0        |
| Shrink (computer)                      |           | -17,075.0        | -6,687.0        | -173.0         | -285.0         | -24,220.0        |
| <b>Shrink (corrected)</b>              |           | <b>-16,667.0</b> | <b>-5,958.0</b> | <b>-106.0</b>  | <b>-213.0</b>  | <b>-22,944.0</b> |
| Miscellaneous Excavation               |           |                  |                 |                |                |                  |
| Turnouts                               | <b>MX</b> | 261.0            | 22.0            |                |                | 283.0            |
| Shrink                                 |           | -26.0            | -4.0            |                |                | -30.0            |
| <b>SUBTOTAL RDWY EXCAVATION</b>        |           | <b>120,586.0</b> | <b>25,143.0</b> | <b>1,727.0</b> | <b>1,425.0</b> | <b>148,881.0</b> |
| <b>SUBTOTAL RWDY EXC SHRINK (Corr)</b> |           | <b>-16,693.0</b> | <b>-5,962.0</b> | <b>-106.0</b>  | <b>-213.0</b>  | <b>-22,974.0</b> |
| Drainage Excavation                    | <b>DX</b> | 179.0            | 146.0           |                |                | 325.0            |
| Shrink                                 |           | -19.0            | -15.0           |                |                | -34.0            |
| Structural Excavation                  | <b>SX</b> | 645.0            | 2,875.0         |                |                | 3,520.0          |
| Shrink                                 |           | -65.0            | -287.0          |                |                | -352.0           |
| Channel Excavation                     | <b>CX</b> | 18,347.0         |                 |                |                | 18,347.0         |
| Shrink                                 |           | -1,835.0         |                 |                |                | -1,835.0         |
| Pipe Excavation                        | <b>PX</b> | 251.0            | 572.0           |                |                | 823.0            |
| Shrink                                 |           | -28.0            | -60.0           |                |                | -88.0            |
| <b>TOTAL EXCAVATION (Computer)</b>     | <b>TX</b> | <b>120,960.0</b> | <b>21,683.0</b> | <b>1,554.0</b> | <b>1,140.0</b> | <b>145,337.0</b> |
| <b>TOTAL EXCAVATION (Corrected)</b>    |           | <b>121,368.0</b> | <b>22,412.0</b> | <b>1,621.0</b> | <b>1,212.0</b> | <b>146,613.0</b> |
| Haul In                                | <b>HI</b> |                  |                 |                |                | 0.0              |
| Shrink                                 |           |                  |                 |                |                | 0.0              |
| <b>TOTAL</b>                           |           | <b>120,960.0</b> | <b>21,683.0</b> | <b>1,554.0</b> | <b>1,140.0</b> | <b>145,337.0</b> |
| <b>TOTAL (Corrected)</b>               |           | <b>121,368.0</b> | <b>22,412.0</b> | <b>1,621.0</b> | <b>1,212.0</b> | <b>146,613.0</b> |
| Roadway Embankment                     | <b>RM</b> | 116,812.0        | 11,210.0        | 928.0          | 474.0          | 129,424.0        |
| Turnout Embankment                     | <b>MM</b> | 124.0            | 401.0           |                |                | 525.0            |
| Channel Embankment (Berm)              | <b>CM</b> | 35.0             |                 |                |                | 35.0             |
| Ground Compaction                      | <b>GC</b> | 1,328.0          | 726.0           | 19.0           | 15.0           | 2,088.0          |
| Pipe Culvert Roadway Emb Adjustment    | <b>CA</b> | -1,955.0         | 0.0             |                |                | -1,955.0         |
| <b>SUBTOTAL EMBANKMENT</b>             |           | <b>116,344.0</b> | <b>12,337.0</b> | <b>947.0</b>   | <b>489.0</b>   | <b>130,117.0</b> |
| Structure Backfill                     | <b>SB</b> | 787.0            | 1,248.0         |                |                | 2,035.0          |
| Pipe Backfill                          | <b>PB</b> | 156.0            | 146.0           |                |                | 302.0            |
| Trench Backfill                        | <b>TB</b> |                  | 1,390.0         |                |                | 1,390.0          |
| <b>TOTAL EMBANKMENT</b>                | <b>TM</b> | <b>117,287.0</b> | <b>15,121.0</b> | <b>947.0</b>   | <b>489.0</b>   | <b>133,844.0</b> |
| Haul Out                               | <b>HO</b> |                  |                 |                |                | 0.0              |
| <b>TOTAL</b>                           |           | <b>117,287.0</b> | <b>15,121.0</b> | <b>947.0</b>   | <b>489.0</b>   | <b>133,844.0</b> |
| Waste (adjusted)                       | <b>W</b>  | 3,673.0          | 6,562.0         | 607.0          | 651.0          | 11,493.0         |
| <b>Waste (corrected)(W/0.9)</b>        |           | <b>4,081.0</b>   | <b>7,291.0</b>  | <b>674.0</b>   | <b>723.0</b>   | <b>12,769.0</b>  |

The "corrected" values indicate those items that need to be recomputed in order to correct the shrink factor from the waste. The computer automatically calculates all roadway excavation with the shrink factor applied. However, the waste value should not include the shrink factor. Therefore, the Waste (adjusted) item was divided by (1-shr%) to determine the "unshrunk" or corrected value. The total excavation was then recomputed with the corrected values.

## EARTHWORK CALCULATIONS PROJECT EXAMPLES

### PROJECT EXAMPLE NO. 2: Single Roadway Reconstruction Project with Waste Material

This sample project is a simple two-lane roadway reconstruction with hypothetical numbers rounded to emphasize the calculation of the waste volume. This project has waste material and the numbers show that not all of the roadway excavation is adjusted for shrink, only that volume that is used for embankment.

#### EARTHWORK SUMMARY TABLE AND EARTHWORK FACTOR TABLE ON PLANS

| EARTHWORK QUANTITIES       |            |
|----------------------------|------------|
| Roadway Excavation         | 100,000 CY |
| Shrink                     | 9,767 CY   |
| Drainage Excavation        | 2,000 CY   |
| Shrink                     | 200 CY     |
| Structural Excavation      | 4,000 CY   |
| Shrink                     | 400 CY     |
| Pipe Excavation            | 3,000 CY   |
| Shrink                     | 300 CY     |
| Pipe Backfill              | 1,000 CY   |
| Structure Backfill         | 6,000 CY   |
| Embankment (Incl Gnd Comp) | 89,000 CY  |
| Waste                      | 2,333 CY   |

| EARTHWORK FACTORS |              |                   |
|-------------------|--------------|-------------------|
| Station           | Shrink/Swell | Ground Compaction |
| 100+00 to 250+00  | 10% Shrink   | 0.10'             |

#### SAMPLE EARTHWORK WORKSHEET INCLUDED IN EARTHWORK DOCUMENTATION SHEETS

##### SAMPLE CALCULATION STEPS

Initial calculations determined that the project is in a waste condition. A safe assumption is that the Waste will come from Roadway Excavation.

- 1 - Determine Initial Net Quantity using all quantities except for Rdwy Exc, Shr on Rdwy Exc and Waste.
- 2 - Determine Calculation Factor for Roadway Excavation. Calculation Factor = 1.0 + Shrink/Swell Factor.
- 3 - Determine Required Exc to come from Rdwy Exc. Initial Net Quantity divided by reciprocal of Shrink = Required Exc.
- 4 - Calculate Shrink on Rdwy Exc. Required Exc x Shr Factor = Rdwy Exc Shr Amount.
- 5 - Calculate Waste. Rdwy Exc - Required Exc = Waste Amount.
- 6 - Execute Final Check.

Step 1 >

| PRIMARY CALCULATIONS   |            |           |
|------------------------|------------|-----------|
|                        | Exc (+)    | Emb (-)   |
| Rdwy Exc               | 100,000 CY |           |
| Shrink                 |            | ?         |
| Drm Exc                | 2,000 CY   |           |
| Shrink                 |            | 200 CY    |
| Str Exc                | 4,000 CY   |           |
| Shrink                 |            | 400 CY    |
| Pipe Exc               | 3,000 CY   |           |
| Shrink                 |            | 300 CY    |
| Pipe Bkfl              |            | 1,000 CY  |
| Str Bkfl               |            | 6,000 CY  |
| Emb (Incl Gnd Comp)    |            | 89,000 CY |
| Waste                  |            | ?         |
|                        | 9,000 CY   | 96,900 CY |
| Initial Net Quantity = |            | -9,000 CY |
|                        |            | 87,900 CY |

Step 6 >

| FINAL CHECK          |            |             |
|----------------------|------------|-------------|
|                      | Exc (+)    | Emb (-)     |
| Rdwy Exc             | 100,000 CY |             |
| Shrink               |            | 9,767 CY    |
| Drm Exc              | 2,000 CY   |             |
| Shrink               |            | 200 CY      |
| Str Exc              | 4,000 CY   |             |
| Shrink               |            | 400 CY      |
| Pipe Exc             | 3,000 CY   |             |
| Shrink               |            | 300 CY      |
| Pipe Bkfl            |            | 1,000 CY    |
| Str Bkfl             |            | 6,000 CY    |
| Emb (Incl Gnd Comp)  |            | 89,000 CY   |
| Waste                |            | 2,333 CY    |
|                      | 109,000 CY | 109,000 CY  |
| Final Net Quantity = |            | -109,000 CY |
|                      |            | 0 OK        |

- Step 2 > 1.0 plus (-0.1)(10% Shr) = 0.9 = Calculation Factor
- Step 3 > 87,900 divided 0.9 = 97,667 = Required Exc
- Step 4 > 97,667 times 0.1 = 9,767 = Rdwy Exc Shr
- Step 5 > 100,000 minus 97,667 = 2,333 = Waste

Shaded areas = Not used in Primary Calculations

## PROJECT EXAMPLE NO. 2

## EARTHWORK CALCULATIONS PROJECT EXAMPLES

### PROJECT EXAMPLE NO. 3: Single Roadway Reconstruction Project with Borrow

This sample project is a simple two-lane roadway reconstruction with rounded numbers to emphasize the calculation of the imported volume. This project will require imported material and the numbers show that all of the roadway excavation is adjusted for shrink. Borrow from a pit and Haul In from a different phase within the project are calculated in the same manner.

#### EARTHWORK SUMMARY TABLE AND EARTHWORK FACTOR TABLE ON PLANS

| EARTHWORK QUANTITIES       |           |
|----------------------------|-----------|
| Roadway Excavation         | 50,000 CY |
| 10% Shrink                 | 5,000 CY  |
| Drainage Excavation        | 2,000 CY  |
| 10% Shrink                 | 200 CY    |
| Structural Excavation      | 4,000 CY  |
| 10% Shrink                 | 400 CY    |
| Pipe Excavation            | 3,000 CY  |
| 10% Shrink                 | 300 CY    |
| Borrow (Pit)               | 50,471 CY |
| 15% Shrink                 | 7,571 CY  |
| Pipe Backfill              | 1,000 CY  |
| Structure Backfill         | 6,000 CY  |
| Embankment (Incl Gnd Comp) | 89,000 CY |

| EARTHWORK FACTORS |              |                   |
|-------------------|--------------|-------------------|
| Station           | Shrink/Swell | Ground Compaction |
| Borrow (Pit)      | 15% Shrink   |                   |
| 100+00 to 250+00  | 10% Shrink   | 0.10'             |

#### SAMPLE EARTHWORK WORKSHEET INCLUDED IN EARTHWORK DOCUMENTATION SHEETS

##### SAMPLE CALCULATION STEPS

Initial calculations determined that the project will require imported material. Borrow material with a shrink factor of 15% is available from ADOT material pits.

- 1 - Determine Initial Net Quantity using all quantities except for Borrow and Shr on Borrow.
- 2 - Determine Calculation Factor for Borrow. Calculation Factor = 1.0 + Shrink/Swell Factor.
- 3 - Calculate Borrow amount to come from pit. Initial Net Quantity divided by reciprocal of Shrink = Borrow.
- 4 - Calculate Shrink on Borrow. Borrow x Shr Factor = Borrow Shr Amount.
- 5 - Execute Final Check.

Step 1 >

| PRIMARY CALCULATIONS   |           |            |
|------------------------|-----------|------------|
|                        | Exc (+)   | Emb (-)    |
| Rdwy Exc               | 50,000 CY |            |
| 10% Shrink             |           | 5,000 CY   |
| Dm Exc                 | 2,000 CY  |            |
| 10% Shrink             |           | 200 CY     |
| Str Exc                | 4,000 CY  |            |
| 10% Shrink             |           | 400 CY     |
| Pipe Exc               | 3,000 CY  |            |
| 10% Shrink             |           | 300 CY     |
| Borrow (Pit)           | ? CY      |            |
| 15% Shrink             |           | ? CY       |
| Pipe Bkfl              |           | 1,000 CY   |
| Str Bkfl               |           | 6,000 CY   |
| Emb (Incl Gnd Comp)    |           | 89,000 CY  |
|                        | 59,000 CY | 101,900 CY |
|                        |           | -59,000 CY |
| Initial Net Quantity = |           | 42,900 CY  |

Step 5 >

| FINAL CHECK          |            |             |
|----------------------|------------|-------------|
|                      | Exc (+)    | Emb (-)     |
| Rdwy Exc             | 50,000 CY  |             |
| 10% Shrink           |            | 5,000 CY    |
| Dm Exc               | 2,000 CY   |             |
| 10% Shrink           |            | 200 CY      |
| Str Exc              | 4,000 CY   |             |
| 10% Shrink           |            | 400 CY      |
| Pipe Exc             | 3,000 CY   |             |
| 10% Shrink           |            | 300 CY      |
| Borrow (Pit)         | 50,471 CY  |             |
| 15% Shrink           |            | 7,571 CY    |
| Pipe Bkfl            |            | 1,000 CY    |
| Str Bkfl             |            | 6,000 CY    |
| Emb (Incl Gnd Comp)  |            | 89,000 CY   |
|                      | 109,471 CY | 109,471 CY  |
|                      |            | -109,471 CY |
| Final Net Quantity = |            | 0           |

- Step 2 > 1.0 plus (-0.15) (15% Shr) = 0.85 = Calculation Factor
- Step 3 > 42,900 divided 0.85 = 50,471 = Borrow
- Step 4 > 50,471 times 0.15 = 7,571 = Borrow Shr

Shaded Areas Not used in Primary Calculations

# EARTHWORK CALCULATIONS PROJECT EXAMPLES

## PROJECT EXAMPLE NO. 4: Pavement Preservation and Climbing Lane Project

Example No. 4 is from a typical pavement preservation project that includes widening for a climbing lane. A significant volume of excavated material was considered unsuitable material within three feet of the subgrade and had to be over-excavated. This unsuitable material was not allowed to be used on this project and had to be hauled to a local pit. Other projects may allow the unsuitable material to be used in deeper embankments where it would not impact the stability of the subgrade.

### EARTHWORK SUMMARY TABLE AND EARTHWORK FACTOR TABLE ON PLANS

| EARTHWORK QUANTITIES        |           |
|-----------------------------|-----------|
| Roadway Excavation*         | 55,464 CY |
| Shrink                      | 4,256 CY  |
| Drainage Excavation         | 1,209 CY  |
| Shrink                      | 121 CY    |
| Pipe Excavation             | 843 CY    |
| Shrink                      | 84 CY     |
| Borrow (In-Place)           | 49,183 CY |
| No Shrink/Swell             | - CY      |
| Embankment                  | 78,395 CY |
| Ground Compaction           | 4,765 CY  |
| Berms & Dikes               | 4,909 CY  |
| Pipe Backfill               | 1,265 CY  |
| Waste (Unsuitable Material) | 12,904 CY |

| EARTHWORK FACTORS |              |                   |
|-------------------|--------------|-------------------|
| Station           | Shrink/Swell | Ground Compaction |
| 496+25 to 529+42  | 10% Shrink   | 0.10'             |

\*Includes 12,904 CY of Overexcavation (Unsuitable Material)

### SAMPLE EARTHWORK WORKSHEET INCLUDED IN EARTHWORK DOCUMENTATION SHEETS

#### SAMPLE CALCULATION STEPS

Initial calculations determined that the project will require imported material. No ADOT pit is available, however, Borrow material is readily available from various sources, therefore, the Pay Item Borrow (In-Place) will be used.

1 - Determine Initial Net Quantity using all quantities except for \*unusable Overexc (Unsuitable Material), Borrow, Shr on Borrow and Waste.

\*CAUTION: Some projects only restrict the use of the unsuitable material within three feet of the subgrade. See Materials Memo.

2 - Since there is no shr/swl on Borrow (In-Place), it is not necessary to determine the Calculation Factor for Borrow.

3 - Calculate Borrow amount to come from pit. No Shr/Swl, therefore, Initial Net Quantity = Borrow.

4 - Execute Final Check.

| Step 1 >                                     | PRIMARY CALCULATIONS   |            | Step 4 >                    | FINAL CHECK          |             |
|--|------------------------|------------|-----------------------------|----------------------|-------------|
|  | Exc (+)                | Emb (-)    |                             | Exc (+)              | Emb (-)     |
| Rdwy Exc*                                    | 55,464 CY              |            | Rdwy Exc*                   | 55,464 CY            |             |
| Roadway Excavation Available for Embankment* | 42,560 CY              |            |                             |                      |             |
| 10% Shrink                                   |                        | 4,256 CY   | 10% Shrink                  |                      | 4,256 CY    |
| Dm Exc                                       | 1,209 CY               |            | Dm Exc                      | 1,209 CY             |             |
| 10% Shrink                                   |                        | 121 CY     | 10% Shrink                  |                      | 121 CY      |
| Pipe Exc                                     | 843 CY                 |            | Pipe Exc                    | 843 CY               |             |
| 10% Shrink                                   |                        | 84 CY      | 10% Shrink                  |                      | 84 CY       |
| Borrow (In-Place)                            | ? CY                   |            | Borrow (In-Place)           | 49,183 CY            |             |
| No Shrink/Swell                              |                        | - CY       | No Shrink/Swell             |                      | - CY        |
| Embankment                                   |                        | 78,395 CY  | Embankment                  |                      | 78,395 CY   |
| Ground Compaction                            |                        | 4,765 CY   | Ground Compaction           |                      | 4,765 CY    |
| Berms & Dikes                                |                        | 4,909 CY   | Berms & Dikes               |                      | 4,909 CY    |
| Pipe Backfill                                |                        | 1,265 CY   | Pipe Backfill               |                      | 1,265 CY    |
| Waste (Unsuitable Material)                  |                        | 12,904 CY  | Waste (Unsuitable Material) |                      | 12,904 CY   |
|  | 44,612 CY              | 93,795 CY  |                             | 106,699 CY           | 106,699 CY  |
|  |                        | -44,612 CY |                             |                      | -106,699 CY |
|  | Initial Net Quantity = | 49,183 CY  |                             | Final Net Quantity = | 0 OK        |

Step 2 > N/A

Step 3 > Initial Net Quantity = 49,183 = Borrow

Shaded Areas Not used in Primary Calculations

## QUANTITY SUMMARY TABLE EXAMPLES

### QUANTITY SUMMARY TABLE EXAMPLE NO. 1: Roadway Widening Project

Example No. 1 is based on a project with roadway widening in a geologic setting that has rock outcroppings. This example assumes that material can be moved left and right using flaggers. Various shrink factors apply to the excavated material as indicated in the Materials Design Report. Parentheses are used on the Plans Earthwork Quantity summary table on the embankment items that are subtracted from excavation items to verify that the quantities balance. The multi-phase project has excess material in one phase that is hauled and used on the other phase. In this example, the Haul Out quantity is the excavated material necessary for the embankment and includes the additional excavated material to account for shrinkage. Note that shrink and swell is applied only to material that is to be placed within the project. Excavation that is hauled from phase to phase will have the shrink and swell applied at the point of placement.

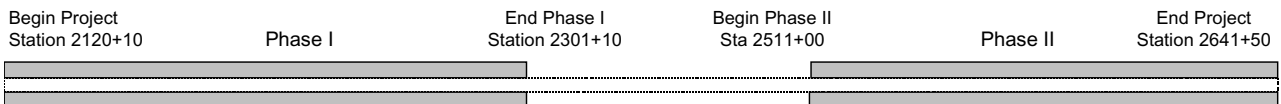

EARTHWORK SUMMARY TABLE AND EARTHWORK FACTOR TABLE ON PLANS

| EARTHWORK QUANTITIES       |          |    |          |    |             |
|----------------------------|----------|----|----------|----|-------------|
|                            | Phase I  |    | Phase II |    | Total       |
| Roadway Excavation         | 64,760   | CY | 32,490   | CY | 97,250 CY   |
| Shrink                     | (4,119)  | CY | (3,249)  | CY | (7,368) CY  |
| Swell                      | 1,635    | CY | 0        | CY | 1,635 CY    |
| Drainage Excavation        | 11,641   | CY | 8,394    | CY | 20,035 CY   |
| Shrink                     | 0        | CY | (839)    | CY | (839) CY    |
| Pipe Excavation            | 2,225    | CY | 1,043    | CY | 3,268 CY    |
| Shrink                     | (356)    | CY | (104)    | CY | (460) CY    |
| Channel Excavation         | 7,193    | CY | 0        | CY | 7,193 CY    |
| Shrink                     | 0        | CY | 0        | CY | 0 CY        |
| Structural Excavation      | 1,208    | CY | 814      | CY | 2,022 CY    |
| Shrink                     | (134)    | CY | (81)     | CY | (215) CY    |
| Haul In                    | 0        | CY | 13,704   | CY | 13,704 CY   |
| Shrink                     | 0        | CY | (2,056)  | CY | (2,056) CY  |
| Embankment (Incl Gnd Comp) | (36,917) | CY | (48,918) | CY | (85,835) CY |
| Pipe Backfill              | (1,211)  | CY | (647)    | CY | (1,858) CY  |
| Trench Backfill            | (653)    | CY | 0        | CY | (653) CY    |
| Structure Backfill         | (834)    | CY | (551)    | CY | (1,385) CY  |
| Haul Out                   | (13,704) | CY | 0        | CY | (13,704) CY |
| Waste                      | (30,734) | CY | 0        | CY | (30,734) CY |

| EARTHWORK FACTORS |    |         |        |     |       |     |                   |
|-------------------|----|---------|--------|-----|-------|-----|-------------------|
| Station           | to | Station | Shrink |     | Swell |     | Ground Compaction |
|                   |    |         | Lt.    | Rt. | Lt.   | Rt. |                   |
| 2120+10           | to | 2170+90 | 10%    | 10% |       |     | 0.25 '            |
| 2170+90           | to | 2201+40 | 15%    | 10% |       |     | 0.2 '             |
| 2201+40           | to | 2225+60 | 15%    | 15% |       |     | 0.2 '             |
| 2225+60           | to | 2261+70 | 15%    | 20% |       |     | 0.1 '             |
| 2261+70           | to | 2269+80 |        |     | 10%   | 10% | 0.1 '             |
| 2269+80           | to | 2275+20 |        |     | 15%   | 15% | 0.1 '             |
| 2275+20           | to | 2301+10 | 15%    | 15% |       |     | 0.2 '             |
| 2511+00           | to | 2641+50 | 10%    | 10% |       |     | 0.2 '             |

## QUANTITY SUMMARY TABLE EXAMPLES

### QUANTITY SUMMARY TABLE EXAMPLE NO. 2: Urban Freeway Project with Construction Phasing

Example No. 2 is taken from an urban freeway project that has three main construction phases, with phase two having two sub phases. Because this is a borrow project, the staging of the earthwork is important. Phases 1 and 2B have extra excavation that is proposed to be used in phases 2a and 3. The haul out and haul in values are shown in the table. Topsoil is also a part of this project. The topsoil excavated from the project site is included in the Roadway Excavation line item. The quantity for topsoil plating is the in-place volume required. A storm drain is proposed as part of this project which includes pipe excavation, pipe backfill and trench backfill quantities in the summary table.

EARTHWORK SUMMARY TABLE AND EARTHWORK FACTOR TABLE ON PLANS

| EARTHWORK QUANTITIES            |         |    |          |    |          |    |         |    |         |    |
|---------------------------------|---------|----|----------|----|----------|----|---------|----|---------|----|
|                                 | Phase 1 |    | Phase 2A |    | Phase 2B |    | Phase 3 |    | TOTAL   |    |
| Roadway Excavation*             | 101,701 | CY | 31,803   | CY | 32,816   | CY | 37,038  | CY | 203,358 | CY |
| Rowy Exc. Available for Embank. | 89,512  | CY | 28,675   | CY | 30,142   | CY | 25,910  | CY | 174,239 | CY |
| Shrink                          | 4,257   | CY | 4,219    | CY | 2,167    | CY | 4,255   | CY | 14,898  | CY |
| Drainage Excavation             | 19,845  | CY | 0        | CY | 0        | CY | 21,661  | CY | 41,506  | CY |
| Shrink                          | 1,985   | CY | 0        | CY | 0        | CY | 2,166   | CY | 4,151   | CY |
| Pipe Excavation                 | 25,116  | CY | 14,631   | CY | 2,191    | CY | 2,622   | CY | 44,560  | CY |
| Shrink                          | 2,512   | CY | 2,926    | CY | 329      | CY | 524     | CY | 6,291   | CY |
| Channel Excavation              | 0       | CY | 6,904    | CY | 27,641   | CY | 0       | CY | 34,545  | CY |
| Shrink                          | 0       | CY | 690      | CY | 2,764    | CY | 0       | CY | 3,454   | CY |
| Structural Excavation           | 4,791   | CY | 2,816    | CY | 0        | CY | 14,702  | CY | 22,309  | CY |
| Shrink                          | 479     | CY | 563      | CY | 0        | CY | 2,940   | CY | 3,982   | CY |
| Haul In                         | 0       | CY | 8,928    | CY | 0        | CY | 72,120  | CY | 81,048  | CY |
| Shrink                          | 0       | CY | 893      | CY | 0        | CY | 10,719  | CY | 11,612  | CY |
| Borrow (In Place)               | 0       | CY | 0        | CY | 0        | CY | 28,536  | CY | 28,536  | CY |
| No Shrink or Swell Applied      |         |    |          |    |          |    |         |    |         |    |
| Embankment (Incl Berms & Dikes) | 47,295  | CY | 41,600   | CY | 34,967   | CY | 107,902 | CY | 231,764 | CY |
| Ground Compaction               | 2,241   | CY | 1,307    | CY | 675      | CY | 6,837   | CY | 11,060  | CY |
| Pipe Backfill                   | 4,119   | CY | 1,098    | CY | 466      | CY | 572     | CY | 6,255   | CY |
| Trench Backfill                 | 6,478   | CY | 2,862    | CY | 985      | CY | 6,991   | CY | 17,316  | CY |
| Structure Backfill              | 6,471   | CY | 5,796    | CY | 0        | CY | 22,645  | CY | 34,912  | CY |
| Haul Out                        | 63,427  | CY | 0        | CY | 17,621   | CY | 0       | CY | 81,048  | CY |

\* Includes Topsoil Excavation

| EARTHWORK FACTORS |    |         |        |     |       |     |                   |
|-------------------|----|---------|--------|-----|-------|-----|-------------------|
| Station           | to | Station | Shrink |     | Swell |     | Ground Compaction |
|                   |    |         | Lt.    | Rt. | Lt.   | Rt. |                   |
| 1078+12           | to | 1121+78 | 10%    | 10% | %     | %   | 0.10'             |
| 1121+78           | to | 1184+04 | 20%    | 15% | %     | %   | 0.25'             |
| 1184+04           | to | 1258+85 | 15%    | 15% | %     | %   | 0.20'             |
| Channels          |    |         | 10%    | 10% | %     | %   | ---               |
| Detention Basin   |    |         | 10%    | 10% | %     | %   | ---               |

| TOPSOIL PLATING QUANTITIES |        |
|----------------------------|--------|
|                            | TOTAL  |
| Topsoil Plating            | 29,119 |

**QUANTITY SUMMARY TABLE EXAMPLES**

**QUANTITY SUMMARY TABLE EXAMPLE No. 3A : Waste Project with Onsite Source for MSE Wall Backfill Materials**

This sample project is a simple two-lane roadway with suitable onsite materials for MSE wall backfills. Reinforced backfill and retained backfill quantities are shown in the Earthwork Summary Table and become part of the earthwork quantity check shown in Figure 709.1. Additionally, notes of clarification regarding all MSE wall backfill materials are added under the Earthwork Summary Table in the plans.

EARTHWORK SUMMARY TABLE AND EARTHWORK FACTOR TABLE SHOWN IN PLANS

| EARTHWORK QUANTITIES       |         |    |
|----------------------------|---------|----|
| ⚠ Roadway Excavation       | 118,699 | CY |
| Shrink                     | 11,312  | CY |
| Drainage Excavation        | 2,132   | CY |
| Shrink                     | 213     | CY |
| Structural Excavation      | 3,878   | CY |
| Shrink                     | 388     | CY |
| Pipe Excavation            | 2,890   | CY |
| Shrink                     | 289     | CY |
| Pipe Backfill              | 1,058   | CY |
| Structure Backfill         | 4,962   | CY |
| Reinforced Backfill        | 9,609   | CY |
| Retained Backfill          | 4,843   | CY |
| Embankment (Incl Gnd Comp) | 89,344  | CY |
| Waste                      | 5,581   | CY |

⚠ Includes 9,057 CY of MSE Excavation  
 Note: Onsite excavation materials are suitable for all MSE wall backfill materials

| EARTHWORK FACTORS |              |                   |
|-------------------|--------------|-------------------|
| Station           | Shrink/Swell | Ground Compaction |
| 100+00 to 250+00  | 10% Shrink   | 0.10'             |

| Exc (+)           | Emb (-) |
|-------------------|---------|
| 118,699           | 11,312  |
| 2,132             | 213     |
| 3,878             | 388     |
| 2,890             | 289     |
|                   | 1,058   |
|                   | 4,962   |
|                   | 9,609   |
|                   | 4,843   |
|                   | 89,344  |
|                   | 5,581   |
| Quantity Check >> |         |
| 127,599           | 127,599 |

**QUANTITY SUMMARY TABLE EXAMPLE No. 3B : Waste Project with Offsite Source for MSE Wall Backfill Materials**

This example uses the same excavation and embankment quantities as Project Example No. 3A with the assumption that onsite excavation materials are unsuitable for MSE wall reinforced backfill and retained backfill materials. The reinforced backfill and retained backfill quantities are not shown in the plans Earthwork Summary Table since it is assumed they come from offsite sources selected by the contractor. Additionally, notes of clarification regarding all MSE wall backfill materials are added under the Earthwork Summary Table in the plans.

EARTHWORK SUMMARY TABLE AND EARTHWORK FACTOR TABLE SHOWN IN PLANS

| EARTHWORK QUANTITIES       |         |    |
|----------------------------|---------|----|
| ⚠ Roadway Excavation       | 118,699 | CY |
| Shrink                     | 9,706   | CY |
| Drainage Excavation        | 2,132   | CY |
| Shrink                     | 213     | CY |
| Structural Excavation      | 3,878   | CY |
| Shrink                     | 388     | CY |
| Pipe Excavation            | 2,890   | CY |
| Shrink                     | 289     | CY |
| Pipe Backfill              | 1,058   | CY |
| Structure Backfill         | 4,962   | CY |
| Embankment (Incl Gnd Comp) | 89,344  | CY |
| Waste                      | 21,639  | CY |

⚠ Includes 9,057 CY of MSE Excavation  
 Note: Onsite excavation materials are unsuitable for MSE wall reinforced backfill and retained backfill materials.

| EARTHWORK FACTORS |              |                   |
|-------------------|--------------|-------------------|
| Station           | Shrink/Swell | Ground Compaction |
| 100+00 to 250+00  | 10% Shrink   | 0.10'             |

| Exc (+)           | Emb (-) |
|-------------------|---------|
| 118,699           | 9,706   |
| 2,132             | 213     |
| 3,878             | 388     |
| 2,890             | 289     |
|                   | 1,058   |
|                   | 4,962   |
|                   | 89,344  |
|                   | 21,639  |
| Quantity Check >> |         |
| 127,599           | 127,599 |

**KEY DIFFERENCES BETWEEN EXAMPLE No. 3A & No. 3B**

Because onsite excavation material is not suitable for MSE Wall backfills, the waste total is increased by an amount required to make 14,452 C.Y. ( 9,609 + 4,843 ) of backfill material. See Basic Example No. 1 for method of calculation.

The Shrink on Roadway Excavation is then reduced since shrink is not computed on waste material.

$$( \text{Reinforced Backfill} + \text{Retained Backfill} ) / ( 1.0 - \text{Shrink Factor} ) * \text{Shrink Factor} = \text{Reduced Shrink Amount}$$

Embankment type (-) Shrink on Roadway Excavation is reduced by 1,606 CY. ( 9,609 + 4,843 ) / 0.9 \* 0.1 = 1,606

Embankment types (-) Reinforced Backfill (9,609) & Retained Backfill (4,843) quantities are omitted from table.

Embankment type (-) Waste quantity is increased by 16,058 CY (9,609 + 4,843 + 1,606). 5,581 + 16,058 = 21,639

**QUANTITY SUMMARY TABLE EXAMPLES**

**QUANTITY SUMMARY TABLE EXAMPLE No. 4A : Borrow Project with Onsite Source for MSE Wall Backfill Materials**

This sample project is a simple two-lane roadway with suitable onsite materials for MSE wall backfills. Reinforced backfill and retained backfill quantities are shown in the Earthwork Summary Table and become part of the earthwork quantity check shown in Figure 709.1. Additionally, notes of clarification regarding all MSE wall backfill materials are added under the Earthwork Summary Table in the plans.

EARTHWORK SUMMARY TABLE AND EARTHWORK FACTOR TABLE SHOWN IN PLANS

| EARTHWORK QUANTITIES       |         |    |
|----------------------------|---------|----|
| ? Roadway Excavation       | 118,699 | CY |
| Shrink                     | 11,870  | CY |
| Drainage Excavation        | 2,132   | CY |
| Shrink                     | 213     | CY |
| Structural Excavation      | 3,878   | CY |
| Shrink                     | 388     | CY |
| Pipe Excavation            | 2,890   | CY |
| Shrink                     | 289     | CY |
| Borrow (In-Place)          | 36,977  | CY |
| No Shrink/Swell            | -       | CY |
| Pipe Backfill              | 1,058   | CY |
| Structure Backfill         | 4,962   | CY |
| Reinforced Backfill        | 9,609   | CY |
| Retained Backfill          | 4,843   | CY |
| Embankment (Incl Gnd Comp) | 131,344 | CY |

| EARTHWORK FACTORS |              |                   |
|-------------------|--------------|-------------------|
| Station           | Shrink/Swell | Ground Compaction |
| 100+00 to 250+00  | 10% Shrink   | 0.10'             |

|                   | Exc (+) | Emb (-) |
|-------------------|---------|---------|
|                   | 118,699 | 11,870  |
|                   | 2,132   | 213     |
|                   | 3,878   | 388     |
|                   | 2,890   | 289     |
|                   | 36,977  | -       |
|                   |         | 1,058   |
|                   |         | 4,962   |
|                   |         | 9,609   |
|                   |         | 4,843   |
|                   |         | 131,344 |
| Quantity Check >> | 164,576 | 164,576 |

? Includes 9,057 CY of MSE Excavation  
 Note: Onsite excavation materials are suitable for all MSE wall backfill materials

**QUANTITY SUMMARY TABLE EXAMPLE No. 4B : Borrow Project with Offsite Source for MSE Wall Backfill Materials**

This example uses the same excavation and embankment quantities as Project Example No. 4A with the assumption that onsite excavation materials are unsuitable for MSE wall reinforced backfill and retained backfill materials. The reinforced backfill and retained backfill quantities are not shown in the plans Earthwork Summary Table since it is assumed they come from offsite sources selected by the contractor. Additionally, notes of clarification regarding all MSE wall backfill materials are added under the Earthwork Summary Table in the plans.

EARTHWORK SUMMARY TABLE AND EARTHWORK FACTOR TABLE SHOWN IN PLANS

| EARTHWORK QUANTITIES       |         |    |
|----------------------------|---------|----|
| ? Roadway Excavation       | 118,699 | CY |
| Shrink                     | 11,870  | CY |
| Drainage Excavation        | 2,132   | CY |
| Shrink                     | 213     | CY |
| Structural Excavation      | 3,878   | CY |
| Shrink                     | 388     | CY |
| Pipe Excavation            | 2,890   | CY |
| Shrink                     | 289     | CY |
| Borrow (In-Place)          | 22,525  | CY |
| No Shrink/Swell            | -       | CY |
| Pipe Backfill              | 1,058   | CY |
| Structure Backfill         | 4,962   | CY |
| Embankment (Incl Gnd Comp) | 131,344 | CY |

| EARTHWORK FACTORS |              |                   |
|-------------------|--------------|-------------------|
| Station           | Shrink/Swell | Ground Compaction |
| 100+00 to 250+00  | 10% Shrink   | 0.10'             |

|                   | Exc (+) | Emb (-) |
|-------------------|---------|---------|
|                   | 118,699 | 11,870  |
|                   | 2,132   | 213     |
|                   | 3,878   | 388     |
|                   | 2,890   | 289     |
|                   | 22,525  | -       |
|                   |         | 1,058   |
|                   |         | 4,962   |
|                   |         | 131,344 |
| Quantity Check >> | 150,124 | 150,124 |

? Includes 9,057 CY of MSE Excavation  
 Note: Onsite excavation materials are unsuitable for MSE wall reinforced backfill and retained backfill materials.

**KEY DIFFERENCES BETWEEN EXAMPLE No. 4A & No. 4B**

Because onsite excavation material is not suitable for MSE Wall backfills, all the excavation on the project will go toward making embankment, thereby, reducing the Borrow amount required by 14,452 C.Y. ( 9,609 + 4,843 ) which is the total of MSE Wall backfill required.

Excavation type (+) Borrow (In-Place) is reduced by 14,452 CY ( 9,609 + 4,843 ).

Embankment types (-) Reinforced Backfill (9,609) & Retained Backfill (4,843) quantities are omitted from table.







# PIPE EXCAVATION AND BACKFILL COMPUTATIONS

## PIPE EXCAVATION EXAMPLE NO. 1: Calculation Summary

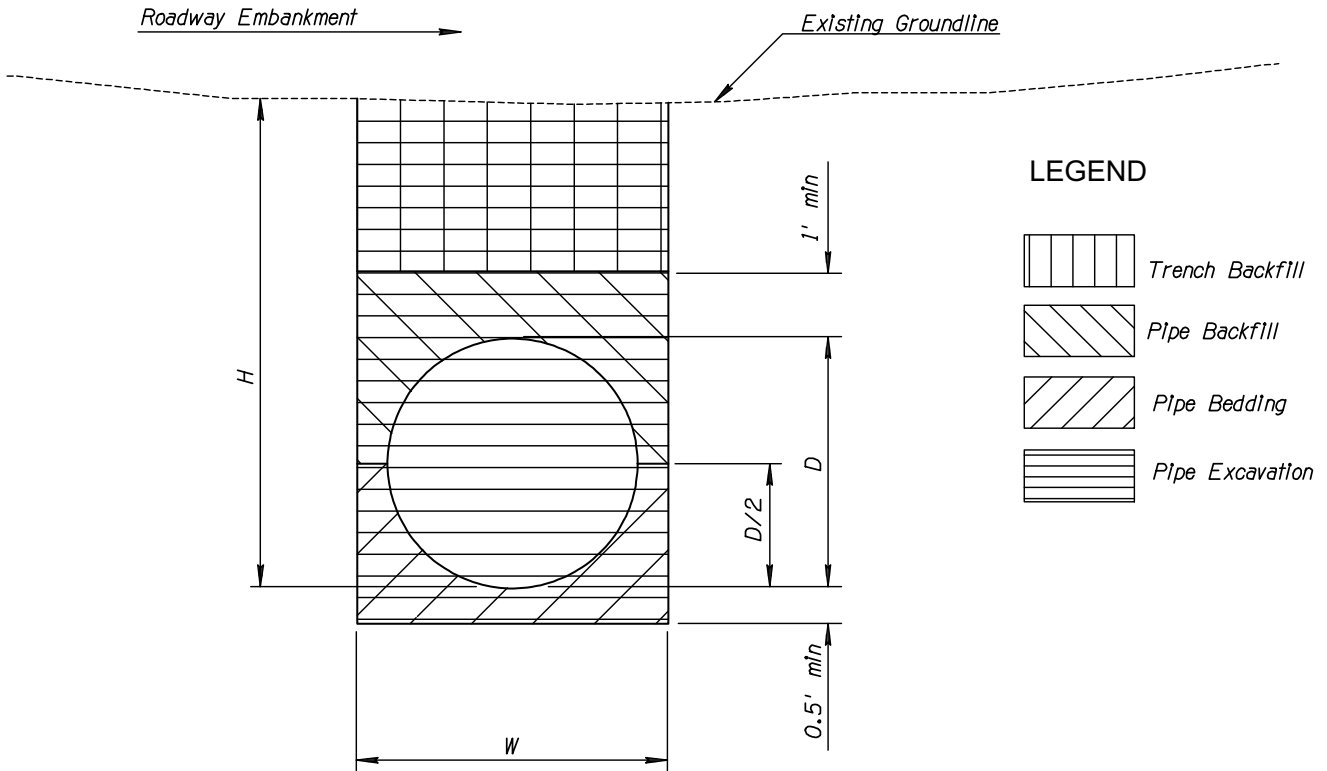

Excav. Depth =  $H + 0.5'$ (min.)

Bedding Depth =  $D/2 + 0.5'$  (min.)

Pipe Bedding =  $(D/2 + 0.5') \cdot (W/27) \cdot L - \text{Pipe Vol.}/2$

Pipe Backfill =  $(D/2 + 1') \cdot (W/27) \cdot L - \text{Pipe Vol.}/2$

Pipe Volume =  $\frac{\pi (D/2)^2 \cdot L \cdot N}{27}$

Pipe Excavation Volume =  $(\text{Excavation Depth} \times W) \cdot (L/27)$

Trench Backfill = Pipe Excavation Volume – Pipe Bedding – Pipe Backfill – Pipe Volume

### COMPUTATIONS

(Based on ADOT Std. C-13/15 for the Trench Condition)

$W = D + K + (N - 1) \cdot S$

D = Pipe Diameter (Outside) (ft.)

K = 2-ft. for  $D < 48$  in. or 3-ft. for  $D \geq 48$  in.(ft.)

N = Number of Pipes

S = Spacing Between Centerlines of Pipes (ft.) See ADOT Std. C-13.10 or Plans

L = Pipe Length (ft.), add  $2 \times D$  to account for headwalls and/or end sections, if applicable

## URBAN HIGHWAY EARTHWORK CALCULATIONS EXAMPLE

### URBAN EXAMPLE NO. 1: Urban Highway with Topsoil

| EARTHWORK QUANTITIES                           |                         |
|--|-------------------------|
|  | TOTAL                   |
| Roadway Excavation*                            | 303,963 m <sup>3</sup>  |
| Shrinkage                                      | (12,890) m <sup>3</sup> |
| Drainage Excavation                            | 890 m <sup>3</sup>      |
| Shrinkage                                      | (0) m <sup>3</sup>      |
| Interceptor Channel & Rip Rap Basin Excavation | 39,720 m <sup>3</sup>   |
| Shrinkage                                      | (4,613) m <sup>3</sup>  |
| Pipe Excavation                                | 17,786 m <sup>3</sup>   |
| Shrinkage                                      | (0) m <sup>3</sup>      |
| Structural Excavation                          | 32,625 m <sup>3</sup>   |
| Shrinkage                                      | (3,296) m <sup>3</sup>  |
| Topsoil Plating Material                       | (88,303) m <sup>3</sup> |
| Total Excavation                               | 306,681 m <sup>3</sup>  |
| Total Shrinkage                                | (20,799) m <sup>3</sup> |
| Total Excavation (Shrunk)                      | 285,882 m <sup>3</sup>  |
| Embankment**                                   | 955,051 m <sup>3</sup>  |
| Ground Compaction (50 mm)                      | 0 m <sup>3</sup>        |
| Total Embankment                               | 955,051 m <sup>3</sup>  |
| Total Project Borrow (In Place)                | 669,169 m <sup>3</sup>  |
| ADOT Furnished Borrow (In Place)               | (92,233) m <sup>3</sup> |
| Total Contractor Furnished Borrow (In Place)   | 576,936 m <sup>3</sup>  |

\* Includes Topsoil/Collapsible Soil Excavation

\*\* Includes Pipe Trench Backfill

This example is intended to illustrate documentation tables and formats – Please disregard that the quantities are shown in metric.

Computed by: TMV 6-9-99  
 Checked by: B.C.O. 6-10-99  
 Approved by: MRC 6-10-99

Sheet No. 5 of 121

**EXCAVATION  
 (Pima Freeway)  
 (Phase B)**

**ROADWAY EXCAVATION**

|  |                   |                    |
|--|-------------------|--------------------|
| Roadway Excavation                     | 116,519 CM        | <i>See page 40</i> |
| Shrinkage                              | (146) CM          |                    |
| Additional Plating Cut                 | 14,705 CM         | <i>See page 49</i> |
| Shrinkage                              | (79) CM           |                    |
| Sub-Excavation Topsoil                 | 88,303 CM         | <i>See page 52</i> |
| No Shrinkage (Even Shr/Swl Factor)     | 0 CM              |                    |
| Sub-Excavation Collapsible Soil        | 84,436 CM         | <i>See page 52</i> |
| Shrinkage                              | (12,665) CM       |                    |
| <b>* Total Roadway Excavation</b>      | <b>303,963 CM</b> |                    |
| Roadway Excavation For Topsoil Plating | (88,303) CM       |                    |
| Excavation                             | 215,660 CM        |                    |
| Embankment                             |                   |                    |
| Shrinkage                              | (12,890) CM       |                    |

**DRAINAGE EXCAVATION**

|                                  |               |                    |
|----------------------------------|---------------|--------------------|
| <b>* Drainage Excavation</b>     | <b>890 CM</b> | <i>See page 64</i> |
| Shrinkage                        | 0 CM          |                    |
| <b>Total Drainage Excavation</b> | <b>890 CM</b> |                    |
| <b>Total Shrinkage</b>           | <b>0 CM</b>   |                    |

**INTERCEPTOR CHANNEL & RIP RAP BASIN EXCAVATION**

|                                    |                   |                    |
|------------------------------------|-------------------|--------------------|
| Interceptor Channel Excavation     | 30,753 CM         | <i>See page 64</i> |
| Shrinkage                          | (4,613) CM        |                    |
| Riprap Basin Excavation            | 8,967 CM          | <i>See page 64</i> |
| Shrinkage                          | 0 CM              |                    |
| <b>Total Incidental Excavation</b> | <b>39,720 CM</b>  |                    |
| <b>Total Shrinkage</b>             | <b>(4,613) CM</b> |                    |

**PIPE EXCAVATION**

|                              |                  |                    |
|------------------------------|------------------|--------------------|
| Pipe Excavation              | 17,786 CM        | <i>See page 93</i> |
| Shrinkage                    | 0 CM             |                    |
| <b>Total Pipe Excavation</b> | <b>17,786 CM</b> |                    |
| <b>Total Shrinkage</b>       | <b>0 CM</b>      |                    |

NOTE: Raw numbers are denoted by an Outline  
 All others are calculated from the raw numbers in the spreadsheet.

\* Pay Item

Computed by: TMV 6-9-99  
 Checked by: B.C.O. 6-10-99  
 Approved by: MRC 6-10-99

Sheet No. 6 of 121

**STRUCTURAL EXCAVATION**

|                                    |                   |                     |
|------------------------------------|-------------------|---------------------|
| 32nd St. Bridge                    | 360 CM            | <i>See page 99</i>  |
| Even Shrinkage                     | 0 CM              |                     |
| C.A.P. Canal Bridge                | 120 CM            | <i>See page 101</i> |
| Even Shrinkage                     | 0 CM              |                     |
| C.A.P. Basin No. 1 Bridge          | 180 CM            | <i>See page 103</i> |
| Even Shrinkage                     | 0 CM              |                     |
| Tatum Blvd. Bridge                 | 1,810 CM          | <i>See page 105</i> |
| Even Shrinkage                     | 0 CM              |                     |
| 56th St. Bridge                    | 30 CM             | <i>See page 107</i> |
| Even Shrinkage                     | 0 CM              |                     |
| Box Culverts                       | 21,971 CM         | <i>See page 110</i> |
| Shrinkage (15%)                    | (3,296) CM        |                     |
| Retaining Walls                    | 8,154 CM          | <i>See page 117</i> |
| Even Shrinkage                     | 0 CM              |                     |
| <b>Total Structural Excavation</b> | <b>32,625 CM</b>  |                     |
| <b>Total Shrinkage</b>             | <b>(3,296) CM</b> |                     |

**EXCAVATION SUMMARY**

(Available for Embankment)

|  |                    |
|--|--------------------|
| Total Roadway Excavation                     | 215,660 CM         |
| Shrinkage                                    | (12,890) CM        |
| Total Drainage Excavation                    | 890 CM             |
| Shrinkage                                    | 0 CM               |
| Total Interceptor Channel/Rip Rap Excavation | 39,720 CM          |
| Shrinkage                                    | (4,613) CM         |
| Total Pipe Excavation                        | 17,786 CM          |
| Shrinkage                                    | 0 CM               |
| Total Structural Excavation                  | 32,625 CM          |
| Shrinkage                                    | (3,296) CM         |
| <b>Total Excavation</b>                      | <b>306,681 CM</b>  |
| <b>Total Shrinkage</b>                       | <b>(20,799) CM</b> |
| <b>Total Excavation (Shrunk)</b>             | <b>285,882 CM</b>  |

NOTE: Raw numbers are denoted by an Outline  
 All others are calculated from the raw numbers in the spreadsheet.

Computed by: TMV 6-9-99  
 Checked by: B.C.O. 6-10-99  
 Approved by: MRC 6-10-99

Sheet No. 7 of 121

**EMBANKMENT**  
 (Pima Freeway)  
 (Phase B)

**ROADWAY EMBANKMENT**

|   |             |              |
|---|-------------|--------------|
| Common Embankment                               | 891,496 CM  | See page 40  |
| Topsoil Fill                                    | (73,598) CM | See page 49  |
| Interceptor Channel Berms                       | 11,889 CM   | See page 64  |
| Riprap Earthwork                                | 807 CM      | See page 64  |
| Volume Needed for CSA                           | 15,161 CM   | See page 64  |
| Pipe Trench Backfill                            | 8,643 CM    | See page 93  |
| + 32nd St. Bridge Structural Backfill           | (330) CM    | See page 99  |
| + C.A.P. Canal Bridge Structural Backfill       | (190) CM    | See page 101 |
| + C.A.P. Basin No. 1 Bridge Structural Backfill | (200) CM    | See page 103 |
| + Tatum Blvd. Bridge Structural Backfill        | (6,610) CM  | See page 105 |
| + 56th St. Bridge Structural Backfill           | (4,940) CM  | See page 107 |
| Sub-Excavation                                  |             |              |
| Topsoil Material                                | 150,808 CM  | See page 52  |
| Box Culverts                                    |             |              |
| + Volume of Structure and Structural Backfill   | (26,042) CM | See page 110 |
| Retaining Walls                                 |             |              |
| + Volume of Structural Backfill                 | (11,843) CM | See page 117 |
| Subtotal Embankment                             | 955,051 CM  |              |

**GROUND COMPACTION**

|                         |      |              |
|-------------------------|------|--------------|
| Total Ground Compaction | 0 CM | See page 120 |
|-------------------------|------|--------------|

|                  |            |
|------------------|------------|
| Total Embankment | 955,051 CM |
|------------------|------------|

NOTE: Raw numbers are denoted by an Outline  
 All others are calculated from the raw numbers in the spreadsheet.

+ An adjustment to embankment is required since the Structural Backfill quantity is assumed to be imported.

Computed by: TMV 6-9-99  
 Checked by: B.C.O. 6-10-99  
 Approved by: MRC 6-10-99

Sheet No. 8 of 121

**TOPSOIL**  
 (Pima Freeway)  
 (Phase B)

**Topsoil Plating**

|                           |           |                    |
|---------------------------|-----------|--------------------|
| Total Topsoil Cut Volume  | 14,705 CM | <i>See page 49</i> |
| Total Topsoil Fill Volume | 73,598 CM | <i>See page 49</i> |
| * Topsoil Plating         | 88,303 CM |                    |

NOTE: Raw numbers are denoted by an Outline  
 All others are calculated from the raw numbers in the spreadsheet.

\* Pay Item

Computed by: TMV 6-9-99  
 Checked by: B.C.O. 6-10-99  
 Approved by: MRC 6-10-99

Sheet No. 9 of 121

**BORROW**  
 (Pima Freeway)  
 (Phase B)

| <b>Borrow</b>  |              |                                 |
|--|--------------|---------------------------------|
| Total Embankment   | 955,051 CM   | <i>See Page 7</i>               |
| Total Excavation (Shrunk)  | (285,882) CM | <i>See Page 6</i>               |
| Total Project Borrow (In-Place)  |              | 669,169 CM                      |
| * ADOT Furnished Borrow (In-Place)   |              | (92,233) CM <i>See Page 121</i> |
| * Contractor Furnished Borrow (In-Place) <span style="float: right;">576,936 CM</span> |              |                                 |

\* Pay Item

**SUMMARY: SUB-EXCAVATION OF TOPSOIL/COLLAPSIBLE SOIL**

The sub-excavation of collapsible soil ranges from a depth of 1m to .6m. The geopak output summary for this calculation is on page 60.

The existing topsoil stockpile extending from station 54+225 to station 54+350 is calculated by geopak. The output summary for the volume is on page 62. This quantity was calculated separately from the common excavation and embankment, therefore, it is an addition to Roadway Excavation.

|   |                                  |
|---|----------------------------------|
| Sub-Excavation Collapsible Soil Volume      | = 150,808 C.M. (page 60)         |
| - Sub-Excavation Topsoil (plating) material | - <u>(88,303 C.M.)</u> (page 49) |
|   | = 62,505 C.M.                    |
| + Excavation of existing Topsoil Stockpile  | + <u>21,931 C.M.</u> (page 62)   |
|   | = <b>84,436</b>                  |

**EARTHWORK SUMMARY QUANTITY TOTALS:**

## 1. Sub-Excavation Topsoil, Collapsible soil &amp; Topsoil Stockpile

Excavation for Plating = **88,303 C.M.** (Roadway Excavation)

Sub-Excavation Collapsible Soil and Topsoil Stockpile  
= **84,436 C.M.** (Roadway Excavation)

Shrinkage (15%) = **(12,665 C.M.)** (Roadway Excavation)

## 2. Embankment (from void left by sub-excavation)

= **150,808 C.M.** (Roadway Embankment)

## SUMMARY – EXCAVATION &amp; EMBANKMENT QUANTITY BREAKDOWN FOR:

1. INTERCEPTOR CHANNEL
2. DRAINAGE
3. RIP RAP BASIN
4. SOIL CEMENT REQUIREMENT

Interceptor Channel

The volume of the Interceptor Channel was calculated by Geopak. The excavation and fill amounts are totaled on page 76. This channel is in native soil outside the roadway prism and will experience 15% shrink.

|   |                         |
|---|-------------------------|
| Interceptor Channel Excavation Quantity | = 30,753 C.M. (page 76) |
| Shrinkage (15%)                         | = 4,613 C.M.            |

|                             |                         |
|-----------------------------|-------------------------|
| Roadway Embankment Quantity | = 11,889 C.M. (page 76) |
|-----------------------------|-------------------------|

Drainage

This drainage excavation quantity includes only the excavation at the end of the RCBC and irrigator pipe outfalls. The calculation for this is on page 77.

|                     |                      |
|---------------------|----------------------|
| Drainage Excavation | = 890 C.M. (page 77) |
|---------------------|----------------------|

Rip Rap Basin

The excavation for the Rip Rap Basin considers the total excavation required for the basin itself, the rip rap, and the bedding material. This quantity is calculated on page 85.

The volume available for fill is calculated by the following formula:

Available for Fill=  
(Drainage Excavation + Rip Rap Volume – quantities above existing ground – berm fill quantity)

The volume represented by this formula consists of the soil generated by the construction of the rip rap basin. Since the excavation for the basin has been added to excavation, the difference between these two quantities (Rip Rap Basin Ex – Available for Fill) must be added to roadway embankment. This calculation is shown on page 85.

|                          |                        |
|--------------------------|------------------------|
| Rip Rap Basin Excavation | = 8,967 C.M. (page 85) |
|--------------------------|------------------------|

|                                |                      |
|--------------------------------|----------------------|
| Embankment (Rip Rap Earthwork) | = 807 C.M. (page 85) |
|--------------------------------|----------------------|

Soil Cement Requirement

The volume of material needed to construct the soil cement interceptor channel is calculated and totaled on page 90.

|                                     |                         |
|-------------------------------------|-------------------------|
| Volume for CSA (Roadway Embankment) | = 15,161 C.M. (page 90) |
|-------------------------------------|-------------------------|

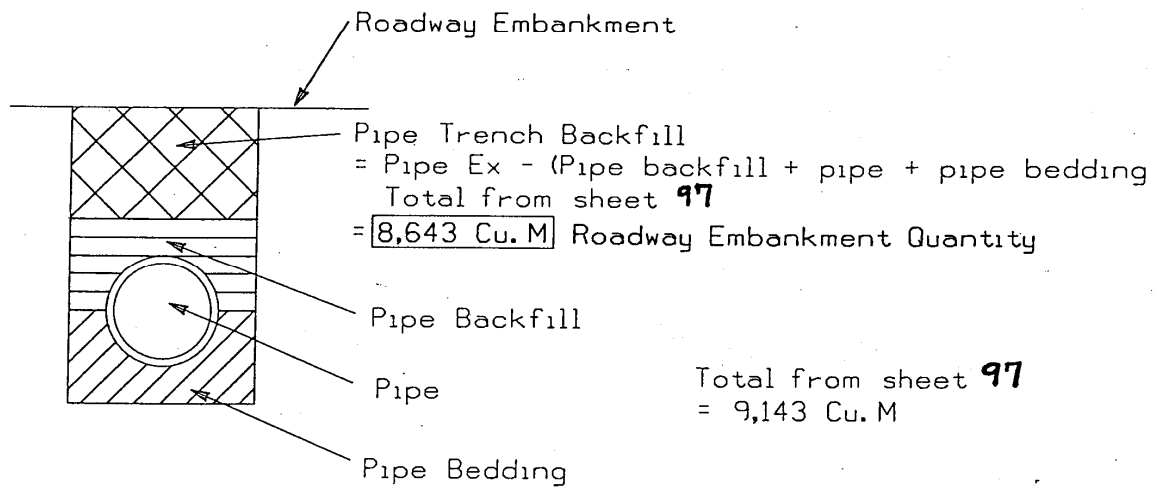
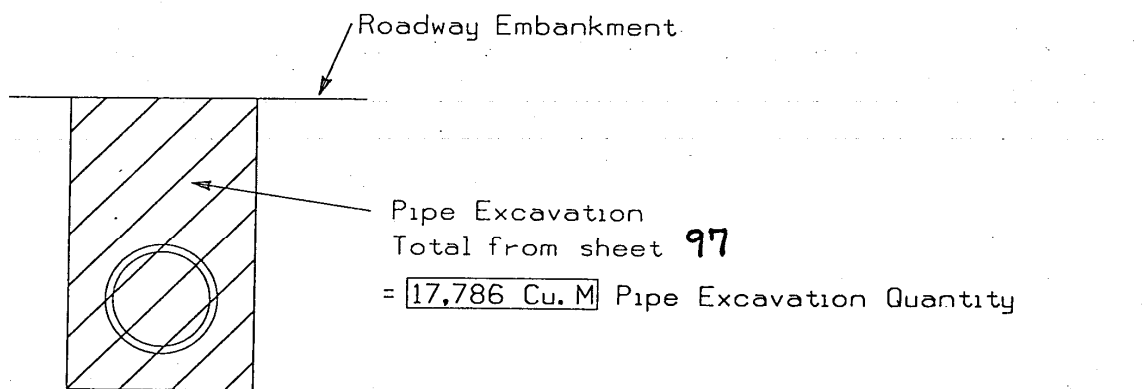

Computed By: TD  
 Checked By: TMV 3-25-99  
 Approved By: SAW

| STORM DRAIN PIPE      |                                 |                               |   |                 |                 |                 |                 |                 |                 |                          |                   |                           |
|-----------------------|---------------------------------|-------------------------------|---|-----------------|-----------------|-----------------|-----------------|-----------------|-----------------|--------------------------|-------------------|---------------------------|
| Project: Pima Freeway |                                 |                               | General Comments: This worksheet calculates quantities for interim. |                 |                 |                 |                 |                 |                 | Drainage Pipe Quantities |                   |                           |
| Project #: 14057      |                                 |                               | Vertical Trench Condition Assumed At All Locations                  |                 |                 |                 |                 |                 |                 |                          |                   |                           |
| Submittal: 100%       |                                 |                               | Pipe Wall Thickness = .075 m For All Types Of Pipes                 |                 |                 |                 |                 |                 |                 |                          |                   |                           |
| Plan Ref #.           | FROM STA & OFFSET               | TO STA & OFFSET               | Pipe Excavation Volume  |                 |                 |                 |                 |                 | Pipe Backfill   | Pipe, Bedding,           | Comments          |                           |
|                       |                                 |                               | Length  | H1              | H2              | H avg           | Diameter        | Volume          | Volume          | Backfill Volume          |                   |                           |
| A1                    | Sta 47+740 20.65 m Rt           | Sta 47+740                    | 21.3  | 1.40            | 1.30            | 1.35            | 0.61            | 43.5            | 14.9            | 35.1                     | CB 10 TO CB 11    |                           |
| A2                    | Sta 48+095 20.65 m Rt           | Sta 48+095 6.305M Rt          | 15.3  | 1.48            | 1.46            | 1.47            | 0.61            | 33.8            | 10.7            | 25.2                     | CB 12 TO CB 13    |                           |
| A3                    | Sta 48+740 27.060 m Rt          | Sta 48+740 1.26M Lt           | 22.9  | 1.54            | 3.40            | 2.47            | 0.61            | 81.6            | 16.0            | 37.7                     | CB 14 TO CB 15    |                           |
| A4                    | Sta 48+840 1.26 m Lt            | Sta 48+740 1.26 m Lt          | <del>Pipe Deleted @ 95%</del>                                       | <del>22.0</del> | <del>1.83</del> | <del>1.54</del> | <del>1.69</del> | <del>0.61</del> | <del>54.9</del> | <del>15.4</del>          | <del>36.2</del>   | <del>CB 17 TO CB 16</del> |
| A5                    | Sta 48+840 20.05 m Rt           | Sta 48+840 1.26 m Lt          | 22.0  | 1.83            | 1.54            | 1.69            | 0.61            | 54.9            | 15.4            | 36.2                     | CB 17 TO CB 16    |                           |
| A6                    | Sta 48+871 20.05 m Rt           | Sta 48+840 20.05 m Rt         | 31.0  | 1.57            | 1.83            | 1.70            | 0.61            | 78.0            | 21.6            | 51.0                     | CB 18 TO CB 17    |                           |
| A7                    | Sta 48+896 20.05 m Rt           | Sta 48+871 20.05 m Rt         | 25.0  | 1.47            | 1.57            | 1.52            | 0.61            | 56.8            | 17.5            | 41.1                     | CB 19 TO CB 18    |                           |
| A8                    | Sta 48+918 20.05 m Rt           | Sta 48+896 20.05 m Rt         | 22.0  | 1.40            | 1.47            | 1.44            | 0.61            | 47.4            | 15.4            | 36.2                     | CB 20 TO CB 19    |                           |
| A9                    | Sta 48+918                      | Sta 48+918 20.05 m Rt         | 22.0  | 0.91            | 1.40            | 1.16            | 0.61            | 39.0            | 15.4            | 36.2                     | CB 21 TO CB 20    |                           |
| A10                   | Sta 48+138.5 1.26 m Rt          | N.A.                          | 0.0   | 0.00            | 0.00            | 0.00            | 0.00            | 0.0             | 0.0             | 0.0                      | CB 22             |                           |
| A11                   | Sta 49+240 1.26 m Rt            | N.A.                          | 0.0   | 0.00            | 0.00            | 0.00            | 0.00            | 0.0             | 0.0             | 0.0                      | CB 23             |                           |
| A12                   | Sta 49+440 1.26 m Rt            | N.A.                          | 0.0   | 0.00            | 0.00            | 0.00            | 0.00            | 0.0             | 0.0             | 0.0                      | CB 24             |                           |
| A13                   | Sta 49+842 20.05 m Rt           | Sta 49+849                    | 21.3  | 1.30            | 1.30            | 1.30            | 0.61            | 42.0            | 14.9            | 35.1                     | CB 25 TO CB 26    |                           |
| A14                   | Sta 49+930 32.484 m Rt          | Sta 49+925 1.26 m Lt          | 34.7  | 1.76            | 1.76            | 1.76            | 0.61            | 90.0            | 24.2            | 57.1                     | CB 28 TO CB 27    |                           |
| A15                   | Sta 50+000 229.246 m Rt         | Sta 49+930 32.484 m Rt        | 70.0  | 2.22            | 1.76            | 1.99            | 0.61            | 203.9           | 48.9            | 115.2                    | CB 29 TO CB 28    |                           |
| A16                   | Sta 50+070 27.300 m Rt          | Sta 50+000 29.246 m Rt        | 70.0  | 2.61            | 2.22            | 2.41            | 0.61            | 244.0           | 48.9            | 115.2                    | CB 30 TO CB 29    |                           |
| A17                   | Sta 50+140 27.25 m Rt           | Sta 50+070 27.3 m Rt          | 70.0  | 2.77            | 2.61            | 2.69            | 0.61            | 270.3           | 48.9            | 115.2                    | CB 31 TO CB 30    |                           |
| A17A                  | Sta 50+207 27.25 m Rt           | Sta 50+140 27.25 m Rt         | 67.0  | 1.80            | 2.77            | 2.29            | 0.61            | 221.9           | 46.8            | 110.3                    | CB 31A TO CB 31   |                           |
| A17B                  | Sta 50+140 1.26 m Lt            | Sta 50+140 27.25 m Rt         | 29.0  | 1.50            | 2.77            | 2.14            | 0.61            | 90.1            | 20.2            | 47.7                     | CB 31A TO CB 31   |                           |
| A18                   | Sta 50+274 27.25 m Rt           | Sta 50+207 27.25 m Rt         | 67.0  | 1.40            | 2.77            | 2.09            | 0.61            | 203.7           | 46.8            | 110.3                    | CB 32 TO CB 31    |                           |
| A19                   | Sta 50+321 27.25 m Rt           | Sta 50+321                    | 28.0  | 1.40            | 1.50            | 1.45            | 0.61            | 60.9            | 19.5            | 46.1                     | CB 33 TO CB 34    |                           |
| A20                   | Sta 51+010                      | Sta 51+006.7 17.6 m Lt        | 18.0  | 1.30            | 1.40            | 1.35            | 0.61            | 36.7            | 12.6            | 29.6                     | CB 35 TO JCT 35   |                           |
| A20A                  | Sta 51+006 20.65m Lt            | Sta 51+080 20.65m Lt          | 74.0  | 2.60            | 1.40            | 2.00            | 0.61            | 216.4           | 51.7            | 121.8                    | CB 35A TO CB 35B  |                           |
| A21                   | Sta 51+015 23.65 m Rt           | Sta 51+010                    | 25.0  | 1.30            | 1.30            | 1.30            | 0.61            | 49.3            | 17.5            | 41.1                     | CB 36 TO CB 35    |                           |
| A22                   | Sta 51+150 24.25 m Rt           | Sta 51+015 23.65 m Rt         | 135.0   | 1.30            | 1.30            | 1.30            | 0.61            | 266.2           | 94.2            | 222.2                    | CB 37 TO CB 36    |                           |
| A23                   | Sta 51+509 20.65 m Lt           |                               | 24.4  | 2.40            | 2.40            | 2.40            | 0.61            | 84.6            | 17.0            | 40.2                     | CB 38 TO EXST CB  |                           |
| A24                   | Sta 51+788 20.65 m Rt           | Sta 51+783.5 21 m Rt          | 6.0   | 3.83            | 3.64            | 3.73            | 0.61            | 31.7            | 4.2             | 9.9                      | CB 39 TO ES 39    |                           |
| A24A                  | Sta 51+765 20.65 m Rt           | Sta 51+778.5 21.25 m Rt       | 13.8  | 1.40            | 1.40            | 1.40            | 0.61            | 29.1            | 9.6             | 22.7                     | CB 38A TO JCT 38A |                           |
| A25                   | Sta 51+800 21.10 m Rt           | Sta 51+788 20.65 m Rt         | 5.0   | 4.49            | 3.96            | 4.23            | 0.61            | 29.8            | 3.5             | 8.2                      | JCT 39 TO CB 39   |                           |
| A26                   | Sta 52+752 20.65 m Lt           | Sta 52+749 20.8 m Lt          | 3.0   | 1.60            | 1.70            | 1.65            | 0.61            | 7.3             | 2.1             | 4.9                      | CB 40 TO JCT 40   |                           |
| A27                   | Sta 52+767                      | Sta 52+752 20.65 m Lt         | 25.6  | 1.30            | 1.60            | 1.45            | 0.61            | 55.7            | 17.9            | 42.1                     | CB 41 TO CB 40    |                           |
| A28                   | Sta 52+783 20.05 m Rt           | Sta 52+767                    | 27.5  | 1.30            | 1.70            | 1.50            | 0.61            | 61.7            | 19.2            | 45.3                     | CB 42 TO CB 41    |                           |
| A29                   | Sta 52+817 20.65 m Rt           | Sta 52+783 20.05 m Rt         | 153.0   | 1.40            | 1.70            | 1.55            | 0.61            | 353.7           | 106.8           | 251.8                    | CB 43 TO CB 42    |                           |
| D1                    | Sta 0+490 (56-A) 3.45 m RT      | Sta 0+490 (56-A) 14.0 m RT    | 10.0  | 0.91            | 0.91            | 0.91            | 0.61            | 14.4            | 7.0             | 16.5                     | CB D1 TO CB D2    |                           |
| D2                    | Sta 0+490 (56-A) 14.0 m RT      | Sta 0+490 (56-B) 12.3 m RT    | 92.0  | 6.00            | 6.00            | 6.00            | 0.61            | 769.5           | 64.2            | 151.4                    | CB D2 TO CB D3    |                           |
| D3                    | Sta 0+469 (56-B) 12.3 m RT      | Sta 0+468 (56-B) 10.4 m RT    | 2.0   | 0.91            | 0.91            | 0.91            | 0.61            | 2.9             | 1.4             | 3.3                      | CB D3 TO JCT D3   |                           |
| E1                    | Sta 0+873.5 (56th St) 23.1 m RT | Sta 0+920 (56th St) 19.5 m LT | 63.0  | 1.40            | 1.80            | 1.60            | 0.61            | 149.9           | 44.0            | 103.7                    | CB E1 TO CB E2    |                           |
| E2                    | Sta 0+920 (56th St) 19.5 m LT   | Sta 0+053 (56-C) 14.3 m RT    | 42.4  | 1.80            | 1.00            | 1.40            | 0.61            | 89.4            | 29.6            | 69.8                     | CB E2 TO CB E3    |                           |
| E3                    | Sta 0+053 (56-C) 14.3 m Lt      | Sta 0+053 (56-C) 7.05 m RLt   | 22.0  | 1.00            | 1.30            | 1.15            | 0.61            | 38.9            | 15.4            | 36.2                     | CB E3 TO CB E4    |                           |
| E4                    | Sta 0+053 (56-C) 11.65 m Rt     | Sta 0+53 (56-C) 7.05 m Rt     | 4.0   | 0.91            | 1.30            | 1.11            | 0.61            | 6.8             | 2.8             | 6.6                      | CB E4 TO ES E4    |                           |
| E5                    | Sta 0+053 (56-C) 7.05 m Rt      | Sta 0+128 (56-C) 7.30 m Rt    | 75.0  | 1.55            | 1.85            | 1.70            | 0.61            | 188.6           | 52.4            | 123.4                    | CB E5 TO ES E5    |                           |

Computed By: SD  
 Checked By: JMV 3-25-99  
 Approved By: SAW

| STORM DRAIN PIPE      |                               |                               |   |      |      |       |          |        |        |                          |                                |          |
|-----------------------|-------------------------------|-------------------------------|---|------|------|-------|----------|--------|--------|--------------------------|--------------------------------|----------|
| Project: Pima Freeway |                               |                               | General Comments: This worksheet calculates quantities for interim. |      |      |       |          |        |        | Drainage Pipe Quantities |                                |          |
| Project #: 14057      |                               |                               | Vertical Trench Condition Assumed At All Locations                  |      |      |       |          |        |        |                          |                                |          |
| Submittal: 100%       |                               |                               | Pipe Wall Thickness = .075 m For All Types Of Pipes                 |      |      |       |          |        |        |                          |                                |          |
| Plan Ref #.           | FROM STA & OFFSET             | TO STA & OFFSET               | Pipe Excavation Volume  |      |      |       |          |        |        | Pipe Backfill Volume     | Pipe, Bedding, Backfill Volume | Comments |
|                       |                               |                               | Length  | H1   | H2   | H avg | Diameter | Volume | Volume |                          |                                |          |
| E6                    | Sta 0+160 (56-C) 5.081 m Lt   | Sta 0+131.3 (56-C) 6.9 m Lt   | 28.7  | 1.40 | 2.76 | 2.08  | 0.61     | 87.0   | 20.0   | 47.2                     | CB E6 TO ES E6                 |          |
| E7                    | Sta 1+054 (56th St) 2.59 m Rt | Sta 1+070 (56th St) 19.5 m Lt | 21.0  | 1.80 | 1.80 | 1.80  | 0.61     | 55.7   | 14.7   | 34.6                     | CB E7 TO CB E8                 |          |
| E8                    | Sta 1+070 (56th St) 19.5 m Lt | Sta 0+040 (56-D) 9.3 m Lt     | 21.5  | 1.80 | 1.00 | 1.40  | 0.61     | 45.3   | 15.0   | 35.4                     | CB E8 TO CB E9                 |          |
| E9                    | Sta 0+040 (56-D) 9.3 m Lt     | Sta 0+066 (56-D) 3.45 m Rt    | 29.5  | 1.00 | 2.12 | 1.56  | 0.61     | 68.6   | 20.6   | 48.5                     | CB E9 TO CB E10                |          |
| E10                   | Sta 0+066 (56-D) 3.45 m Lt    | Sta 0+077.3 (56-D) 4.2 m Rt   | 11.5  | 2.12 | 2.00 | 2.06  | 0.61     | 34.6   | 8.0    | 18.9                     | CB E10 TO ES E10               |          |
| G1                    | Sta 53+553 20.65 m Rt         | Sta 53+596.483 21.25 m Rt     | 44.2  | 1.30 | 5.80 | 3.55  | 0.61     | 222.4  | 30.9   | 72.7                     | CB G1 TO ES G1                 |          |
| G2                    | Sta 53+490 20.65 m Lt         | Sta 53+583 20.65 m Lt         | 93.0  | 1.40 | 1.80 | 1.60  | 0.61     | 221.3  | 64.9   | 153.0                    | CB G2 TO CB G3                 |          |
| G3                    | Sta 53+583 20.65 m Lt         | Sta 53+604.861 21.25 m Lt     | 22.3  | 1.80 | 4.50 | 3.15  | 0.61     | 100.1  | 15.6   | 36.7                     | CB G3 TO ES G3                 |          |
| G4                    | Sta 53+611 28.353 m Rt        | Sta 53+601.17 28.813 m Rt     | 10.6  | 1.70 | 4.40 | 3.05  | 0.61     | 46.1   | 7.4    | 17.4                     | CB G4 TO ES G4                 |          |
| G5                    | Sta 53+625 27.229 m Rt        | Sta 53+611 28.353 m Rt        | 14.0  | 1.40 | 1.70 | 1.55  | 0.61     | 32.4   | 9.8    | 23.0                     | CB G5 TO CB G4                 |          |
| H1                    | Sta 53+716 25.129 m Lt        | Sta 53+796 21.40 m Lt         | 80.0  | 1.30 | 1.80 | 1.55  | 0.61     | 185.0  | 55.8   | 131.6                    | CB H1 TO CB H2                 |          |
| H2                    | Sta 53+796 21.40 m Lt         | Sta 53+834 21.40 m Lt         | 38.0  | 1.80 | 2.00 | 1.90  | 0.61     | 105.9  | 26.5   | 62.5                     | CB H2 TO CB H3                 |          |
| H3                    | Sta 53+834 21.40 m Lt         | Sta 53+850.715 22.0 m Lt      | 4.0   | 2.00 | 2.80 | 2.40  | 0.61     | 13.9   | 2.8    | 6.6                      | CB H3 TO ES H3                 |          |
| H4                    | Sta 53+834 0.960 m Rt         | Sta 53+831.958 0.960 m Rt     | 4.0   | 1.30 | 2.56 | 1.93  | 0.61     | 11.3   | 2.8    | 6.6                      | CB H4 TO ES H4                 |          |
| H5                    | Sta 53+872 21.40 m Lt         | Sta 53+852.631 22.0 m Lt      | 32.0  | 1.30 | 2.92 | 2.11  | 0.61     | 98.4   | 22.3   | 52.7                     | CB H5 TO ES H5                 |          |
| J1                    | Sta 53+967 0.960 m Rt         | Sta 53+955.952 0.960 m Rt     | 11.0  | 1.30 | 3.10 | 2.20  | 0.61     | 35.2   | 7.7    | 18.1                     | CB J1 TO ES J1                 |          |
| J2                    | Sta 53+967 21.40 m Lt         | Sta 53+948.377 22.0 m Lt      | 18.0  | 1.30 | 3.29 | 2.30  | 0.61     | 59.9   | 12.6   | 29.6                     | CB J2 TO ES J2                 |          |
| K1                    | Sta 54+108 21.40 m Lt         | Sta 54+131.399 22.0 m Lt      | 23.5  | 1.80 | 3.67 | 2.74  | 0.61     | 92.2   | 16.4   | 38.7                     | CB K1 TO ES K1                 |          |
| L1                    | Sta 54+235 21.40 m Lt         | Sta 54+342 21.40 m Lt         | 107.0   | 1.30 | 2.00 | 1.65  | 0.61     | 261.9  | 74.7   | 176.1                    | CB L1 TO CB L2                 |          |
| L2                    | Sta 54+342 21.40 m Lt         | Sta 54+353.210 22.0 m Lt      | 5.0   | 2.00 | 2.72 | 2.36  | 0.61     | 17.1   | 3.5    | 8.2                      | CB L2 TO ES L2                 |          |
| M1                    | Sta 54+437 21.4 m Lt          | Sta 54+433.175 22.0 m Lt      | 4.0   | 1.80 | 2.50 | 2.15  | 0.61     | 12.5   | 2.8    | 6.6                      | CB M1 TO ES M1                 |          |
| N1                    | Sta 54+492 21.40 m Lt         | Sta 54+510.301 22.0 m Lt      | 18.0  | 1.30 | 2.71 | 2.01  | 0.61     | 52.8   | 12.6   | 29.6                     | CB N1 TO ES N1                 |          |
| N2                    | Sta 54+530 0.960 m Rt         | Sta 54+515.085 0.960 m Rt     | 15.0  | 1.30 | 2.50 | 1.90  | 0.61     | 41.8   | 10.5   | 24.7                     | CB N2 TO ES N2                 |          |
| N3                    | Sta 54+530 21.40 m Lt         | Sta 54+518.667 22.05 m Lt     | 12.0  | 2.40 | 2.77 | 2.59  | 0.61     | 44.6   | 8.4    | 19.7                     | CB N3 TO ES N3                 |          |
| N4                    | Sta 54+568 21.4 m Lt          | Sta 54+530 21.4 m Lt          | 38.0  | 2.10 | 2.40 | 2.25  | 0.61     | 124.0  | 28.5   | 62.5                     | CB N4 TO ES N4                 |          |
| N5                    | Sta 54+625 21.40 m Lt         | Sta 54+568 21.40 m Lt         | 57.0  | 1.80 | 2.10 | 1.95  | 0.61     | 162.8  | 39.8   | 93.8                     | CB N5 TO ES N5                 |          |
| N6                    | Sta 54+716 21.40 m Lt         | Sta 54+625 21.40 m Lt         | 91.0  | 1.30 | 1.80 | 1.55  | 0.61     | 210.4  | 63.5   | 149.7                    | CB N6 TO CB N5                 |          |
| P1                    | Sta 54+670 21.4 m Rt          | Sta 54+692 21.4 m Rt          | 22.0  | 1.80 | 2.40 | 2.10  | 0.61     | 67.3   | 15.4   | 36.2                     | CB P1 TO CB P2                 |          |
| P2                    | Sta 54+692 21.4 m Rt          | Sta 54+730 21.4 m Rt          | 38.0  | 2.40 | 3.50 | 2.95  | 0.61     | 160.2  | 26.5   | 62.5                     | CB P2 TO CB P3                 |          |
| P3                    | Sta 54+730 21.4 m Rt          | Sta 54+780 22.0 m Rt          | 50.0  | 3.50 | 3.70 | 3.60  | 0.61     | 255.0  | 34.9   | 82.3                     | CB P3 TO ESP3                  |          |
| P4                    | Sta 54+830 21.4 m Rt          | Sta 54+788.2 22 m Rt          | 42.0  | 1.40 | 3.80 | 2.60  | 0.61     | 157.1  | 29.3   | 69.1                     | CB P4 TO ES P4                 |          |
| P5                    | Sta 54+823 21.40 m Lt         | Sta 54+806.376                | 22.0  | 1.30 | 3.10 | 2.20  | 0.61     | 70.3   | 15.4   | 36.2                     | CB P5 TO ES P5                 |          |
| Q1                    | Sta 54+930 21.40 m Lt         | Sta 54+916.684 22.05 m Lt     | 8.3   | 2.40 | 3.50 | 2.95  | 0.61     | 35.0   | 5.8    | 13.7                     | CB Q1 TO ES Q1                 |          |
| Q2                    | Sta 55+023 21.40 m Lt         | Sta 54+940 21.40 m Lt         | 83.0  | 2.20 | 2.40 | 2.30  | 0.61     | 276.6  | 57.9   | 136.6                    | CB Q2 TO CB Q1                 |          |
| Q3                    | Sta 55+115 21.40 m Lt         | Sta 55+023 21.40 m Lt         | 92.0  | 1.80 | 2.20 | 2.00  | 0.61     | 269.0  | 64.2   | 151.4                    | CB Q3 TO CB Q2                 |          |
| Q4                    | Sta 54+930 21.40 m Rt         | Sta 54+901 22.0 m Rt          | 29.0  | 1.80 | 4.30 | 3.05  | 0.61     | 126.2  | 20.2   | 47.7                     | CB Q4 TO ES Q4                 |          |
| Q5                    | Sta 55+020 21.40 m Rt         | Sta 54+930 21.4 m Rt          | 90.0  | 1.40 | 1.80 | 1.60  | 0.61     | 214.2  | 62.8   | 148.1                    | CB Q5 TO CB Q4                 |          |
| R1                    | Sta 55+201 21.40 m Lt         | Sta 55+221.983 22.0 m Lt      | 21.0  | 1.30 | 2.85 | 2.07  | 0.61     | 63.5   | 14.7   | 34.6                     | CB R1 TO ES R1                 |          |
| R2                    | Sta 55+307 21.40 m Lt         | Sta 55+238.018 22.0 m Lt      | 69.0  | 2.80 | 2.63 | 2.72  | 0.61     | 268.9  | 48.2   | 113.5                    | CB R2 TO ES R2                 |          |
| R3                    | Sta 55+372 21.40 m Lt         | Sta 55+307 21.40 m Lt         | 65.0  | 2.10 | 2.80 | 2.45  | 0.61     | 229.8  | 45.4   | 107.0                    | CB R3 TO CB R2                 |          |
| R4                    | Sta 55+410 21.40 m Lt         | Sta 55+372 21.40 m Lt         | 38.0  | 1.80 | 2.10 | 1.95  | 0.61     | 108.5  | 26.5   | 62.5                     | CB R4 TO CB R3                 |          |

95 of 121

Computed By: ISD  
 Checked By: TANV 3-25-99  
 Approved By: SP

| STORM DRAIN PIPE                  |                            |                              |   |      |      |       |          |                 |                |                      |                                |          |
|-----------------------------------|----------------------------|------------------------------|---|------|------|-------|----------|-----------------|----------------|----------------------|--------------------------------|----------|
| Project: Pima Freeway             |                            |                              | General Comments: This worksheet calculates quantities for Interim. |      |      |       |          |                 |                |                      | Drainage Pipe Quantities       |          |
| Project #: 14057                  |                            |                              | Vertical Trench Condition Assumed At All Locations                  |      |      |       |          |                 |                |                      |                                |          |
| Submittal: 100%                   |                            |                              | Pipe Wall Thickness = .075 m For All Types Of Pipes                 |      |      |       |          |                 |                |                      |                                |          |
| Plan Ref #.                       | FROM STA & OFFSET          | TO STA & OFFSET              | Pipe Excavation Volume  |      |      |       |          |                 |                | Pipe Backfill Volume | Pipe, Bedding, Backfill Volume | Comments |
|                                   |                            |                              | Length  | H1   | H2   | H avg | Diameter | Volume          | Volume         | Volume               |                                |          |
| R5                                | Sta 55+410                 | Sta 55+410 21.40 m Lt        | 22.0  | 1.30 | 1.80 | 1.55  | 0.61     | 50.9            | 15.4           | 36.2                 | CB R5 TO CB R4                 |          |
| R6                                | Sta 55+448 21.40 m Lt      | Sta 55+410 21.40 m Lt        | 38.0  | 1.40 | 1.80 | 1.60  | 0.61     | 90.4            | 26.5           | 62.5                 | CB R6 TO CB R4                 |          |
| R7                                | Sta 55+410 27.0 m Lt       | Sta 55+410 21.40 m Lt        | 5.0   | 1.10 | 1.80 | 1.45  | 0.61     | 10.9            | 3.5            | 8.2                  | CB R7 TO CB R4                 |          |
| R8                                | Sta 55+130 21.4 m Rt       | Sta 55+201 21.4 m Rt         | 71.0  | 1.40 | 1.80 | 1.60  | 0.61     | 169.0           | 49.6           | 116.8                | CB R8 TO CB R9                 |          |
| R9                                | Sta 55+201 21.4 m Rt       | Sta 55+222 22.0 m Rt         | 21.0  | 1.80 | 3.15 | 2.48  | 0.61     | 75.0            | 14.7           | 34.6                 | CB R9 TO ES R9                 |          |
| R10                               | Sta 55+307 21.40 m Rt      | Sta 55+??? 22.0 m Rt         | 69.0  | 3.10 | 3.20 | 3.15  | 0.61     | 309.7           | 48.2           | 113.5                | CB R10 TO ES R10               |          |
| R11                               | Sta 55+372 21.40 m Rt      | Sta 55+307 21.40 m Rt        | 65.0  | 2.20 | 3.10 | 2.65  | 0.61     | 247.5           | 45.4           | 107.0                | CB R11 TO CB R10               |          |
| R12                               | Sta 55+410 21.40 m Rt      | Sta 55+372 21.40 m Rt        | 38.0  | 1.80 | 2.56 | 2.18  | 0.61     | 120.4           | 26.5           | 62.5                 | CB R12 TO CB R 11              |          |
| R13                               | Sta 55+448 21.40 m Rt      | Sta 55+410 21.40 m Rt        | 38.0  | 1.40 | 1.80 | 1.60  | 0.61     | 90.4            | 26.5           | 62.5                 | CB R13 TO CB R 13              |          |
| S1                                | Sta 55+513 21.40 m Lt      | Sta 55+615 21.40 m Lt        | 95.0  | 1.70 | 2.44 | 2.07  | 0.61     | 286.8           | 66.3           | 156.3                | CB S1 TO CB S2                 |          |
| S2                                | Sta 55+615 21.40 m Lt      | Sta 55+619 22.05 m Lt        | 12.0  | 2.44 | 2.50 | 2.47  | 0.61     | 42.8            | 8.4            | 19.7                 | CB S2 TO ES S2                 |          |
| S3                                | Sta 55+650 21.40 m Rt      | Sta 55+660.206 22.0 m Rt     | 95.0  | 1.70 | 2.45 | 2.08  | 0.61     | 287.5           | 66.3           | 156.3                | CB S3 TO CBS4                  |          |
| S4                                | Sta 55+608 21.4 m Rt       | Sta 55+632.8 22.0 m Rt       | 25.0  | 2.45 | 2.45 | 2.45  | 0.61     | 88.4            | 17.5           | 41.1                 | CB S4 TO ES S4                 |          |
| T1                                | Sta 55+750 21.40 m Lt      | Sta 55+709.7                 | 40.3  | 1.40 | 3.60 | 2.50  | 0.61     | 145.2           | 28.1           | 66.3                 | CB T1 TO ES T1                 |          |
| U1                                | Sta 55+912 21.40 m Rt      | Sta 55+865 22.0 m Rt         | 47.0  | 1.40 | 5.40 | 3.40  | 0.61     | 226.9           | 32.8           | 77.3                 | CB U1 TO ES U1                 |          |
| V1                                | Sta 55+993 24.792 m Rt     | Sta 56+045.618 29.073 m Rt   | 53.0  | 1.80 | 6.10 | 3.95  | 0.61     | 295.5           | 37.0           | 87.2                 | CB V1 TO ES V1                 |          |
| V2                                | Sta 56+004 24.36 m Lt      | Sta 56+042 7 26.19 m Lt      | 38.7  | 1.80 | 5.60 | 3.70  | 0.61     | 202.6           | 27.0           | 63.7                 | CB V2 TO ES V2                 |          |
| W1                                | Sta 56+130 21.06 m Rt      | Sta 56+163.422 21.25 m Rt    | 34.4  | 1.80 | 7.16 | 4.48  | 0.61     | 216.7           | 24.0           | 56.6                 | CB W1 TO ES W1                 |          |
| W2                                | Sta 56+164 20.65 m Lt      | Sta 56+160.578 21.25 m Lt    | 4.3   | 5.60 | 7.28 | 6.44  | 0.61     | 38.5            | 3.0            | 7.1                  | CB W2 TO ES W2                 |          |
| W3                                | Sta 56+174 31.25 m Rt      | Sta 56+160.578 21.30 m Lt    | 36.4  | 2.40 | 7.50 | 4.95  | 0.61     | 252.5           | 25.4           | 59.9                 | CB W3 TO ES W3                 |          |
| X1                                | Sta 0+350 (SC-A) 4.05 m Lt | Sta 0+366 (SC-A) 4.65 m Lt   | 16.5  | 1.40 | 5.40 | 3.40  | 0.61     | 79.7            | 11.5           | 27.2                 | CB X1 TO ES X1                 |          |
| Y1                                | Sta 0+525 (SC-A) 3.45 m Rt | Sta 0+475.4 (SC-A) 22 m Rt   | 53.0  | 1.69 | 1.80 | 1.75  | 0.61     | 136.6           | 37.0           | 87.2                 | CB Y1 TO ES Y1                 |          |
| Y2                                | Sta 0+560 (SC-A) 3.45 m Rt | Sta 0+525 (SC-A) 3.45 m Rt   | 15.0  | 0.91 | 1.69 | 1.30  | 0.61     | 29.6            | 10.5           | 24.7                 |                                |          |
| Y3                                | Sta 0+498 (SC-B) 4.81 m Rt | Sta 0+489.2 (SC-B) 4.86 m Rt | 14.0  | 1.80 | 2.80 | 2.30  | 0.61     | 46.6            | 9.8            | 23.0                 |                                |          |
| Z1                                | Sta 0+600 (SC-B) 12.0 m Lt | Sta 0+590 (SC-B) 7.05 m Rt   | 22.0  | 0.91 | 1.50 | 1.21  | 0.61     | 40.5            | 15.4           | 36.2                 |                                |          |
| Z2                                | Sta 0+590 (SC-B) 7.05 m Rt | Sta 0+590 (SC-B) 11.5 m Rt   | 3.8   | 1.50 | 1.50 | 1.50  | 0.61     | 8.5             | 2.7            | 6.3                  |                                |          |
| 200                               | Sta 47+510                 |                              |   |      |      | 0.00  |          | 0.0             | 0.0            | 0.0                  |                                |          |
| 201                               | Sta 50+140 1.26 m Lt       | Sta 50+140 27.25 m Rt        | 29.0  | 1.50 | 2.77 | 2.14  | 0.61     | 90.1            | 20.2           | 47.7                 | CB 31B TO CB 31                |          |
| 202                               | Sta 50+525                 | Sta 50+502 2.7 m Rt          | 23.0  | 1.30 | 1.40 | 1.35  | 0.61     | 46.9            | 16.1           | 37.8                 | CB 34A TO JCT 34A              |          |
| 203                               | Sta 52+580                 | Sta 52+565.4                 | 14.6  | 1.40 | 3.50 | 2.45  | 0.61     | 51.6            | 10.2           | 24.0                 | CB 40A TO JCT 40A              |          |
| 204                               | Sta 53+590                 | Sta 53+601                   | 11.5  | 1.40 | 4.90 | 3.15  | 0.61     | 51.6            | 8.0            | 18.9                 | CB G6 TO ES G6                 |          |
| 205                               | Sta 54+342 1.26 m Rt       | Sta 54+347                   | 5.1   | 1.40 | 2.50 | 1.95  | 0.61     | 14.6            | 3.6            | 8.4                  | CB L3 TO ES L3                 |          |
| <b>TOTALS (Storm Drain Pipes)</b> |                            |                              | <b>4,037.9</b>  |      |      |       |          | <b>12,933.3</b> | <b>2,818.8</b> | <b>6,644.8</b>       |                                |          |

96 of 121

Computed By: SD  
 Checked By: TMY 3-25-11  
 Approved By: [Signature]

| IRRIGATOR PIPES                 |                            |   |                        |       |             |                |                                   |  |                               |
|---------------------------------|----------------------------|---|------------------------|-------|-------------|----------------|-----------------------------------|--|-------------------------------|
| Project: Pima Freeway           |                            | General Comments: This worksheet calculates quantities for Interim. |                        |       |             |                |                                   | Irrigator Pipe Quantities                |                               |
| Project #: 14057                |                            | Vertical Trench Condition Assumed At All Locations                  |                        |       |             |                |                                   | ADOT STD DETAIL C-13.15 for Trench Calcs |                               |
| Submittal: 100%                 |                            | Pipe Wall Thickness = .075 m For All Types Of Pipes                 |                        |       |             |                |                                   |  |                               |
| Plan Ref #.                     | FROM STA & OFFSET          | TO STA & OFFSET   | Pipe Excavation Volume |       |             | Pipe Backfill  | Pipe, Pipe Bedding, Pipe Backfill | Comments                                 |                               |
|                                 |                            |   | Length                 | H avg | Diameter    | Volume         | Volume                            | Volume                                   |                               |
| 111                             | Sta 49+059.700 7.0 m RT    | Sta 49+052.904 30.0 m RT  | 23.0                   | 1.92  | 0.76        | 71.9           | 18.7                              | 47.2                                     | JCT 111 TO ES 111             |
| 112                             | Sta 49+359.7 7.1 m RT      | Sta 49+320 28.8 m RT  | 45.0                   | 1.25  | 1.07 x 0.74 | 114.7          | 19.4                              | 109.7                                    | JCT 112 TO ES 112             |
| 113                             | Sta 49+625.300 7.5 m RT    | Sta 49+606.840 28.8 m RT  | 28.2                   | 0.95  | 0.89 x 0.61 | 50.7           | 17.6                              | 56.0                                     | JCT 113 TO ES 113             |
| 114                             | Sta 49+859.600 6.8 m RT    | Sta 49+846.226 27.925 m RT  | 25.0                   | 1.21  | 1.07 x 0.74 | 61.9           | 10.8                              | 61.0                                     | JCT 114 TO ES 114             |
| 115                             | Sta 50+075.6 7.5 m RT      | Sta 50+044.15 34.207 m RT   | 43.0                   | 2.03  | 1.07        | 170.6          | 46.1                              | 130.7                                    | JCT 115 TO ES 115             |
| 116                             | Sta 50+334.4 1.2 m RT      | Sta 50+324 32.4 m RT  | 32.5                   | 1.35  | 0.91        | 80.7           | 30.4                              | 81.5                                     | JCT 116 TO ES 116             |
| 117                             | Sta 53+023.989 44.491 m LT | Sta 53+030.260 45.190 m RT  | 360.0                  | 6.10  | 0.91        | 3735.0         | 337.2                             | 902.4                                    | JCT 117A TO JCT 117B          |
| 118                             | Sta 53+920 37.4 m LT       | Sta 53+920 34.6 m RT  | 72.0                   | 0.60  | 0.91        | 89.6           | 67.4                              | 180.5                                    | INTERCEPTOR CHANNEL TO ES 118 |
| 119                             | Sta 54+210 47.4 m LT       | Sta 54+210 34.6 m RT  | 82.0                   | 0.60  | 0.91        | 102.1          | 76.8                              | 205.5                                    | INTERCEPTOR CHANNEL TO ES 119 |
| 120                             | Sta 54+767 42.7 m LT       | Sta 54+731.3 28.8 m RT  | 80.0                   | 0.60  | 0.91        | 99.6           | 74.9                              | 200.5                                    | INTERCEPTOR CHANNEL TO ES 120 |
| 121                             | Sta 55+150 52.8m LT        | Sta 55+102.9 29.6 m RT  | 95.0                   | 0.60  | 0.91        | 118.3          | 89.0                              | 238.1                                    | INTERCEPTOR CHANNEL TO ES 121 |
| 122                             | Sta 55+290 34.5 m LT       | Sta 55+290 29.5 m RT  | 64.0                   | 0.60  | 0.91        | 79.7           | 60.0                              | 160.4                                    | INTERCEPTOR CHANNEL TO ES 122 |
| 123                             | Sta 55+457.3 44.32 m LT    | Sta 55+482 27.5 m RT  | 76.0                   | 0.60  | 0.61        | 77.5           | 53.1                              | 125.1                                    | INTERCEPTOR CHANNEL TO ES 123 |
| <b>TOTALS (Irrigator Pipes)</b> |                            |   | <b>1,025.7</b>         |       |             | <b>4,852.2</b> | <b>901.5</b>                      | <b>2,498.6</b>                           |                               |

To calculate Pipe Trench Backfill (Roadway Embankment Quantity), use  
 (PIPE EXCAVATION) - (PIPE, PIPE BEDDING, PIPE BACKFILL) = PIPE TRENCH BACKFILL

| PIPE EXCAVATION SUMMARY                       | (Pipe Excavation) | (Pipe, Pipe Bedding, Pipe Backfill) | Pipe Trench Backfill: |
|---|-------------------|-------------------------------------|-----------------------|
| Totals For Storm Drain Pipes (Previous page): | 12,933.3          | 6,644.8                             | 6,289                 |
| Totals For Irrigator Pipes (This page):       | 4,852.2           | 2,498.6                             | 2,354                 |
| <b>Total Pipe Excavation Quantities:</b>      | <b>17,786</b>     | <b>(9,143)</b>                      | <b>= (8,643)</b>      |

URBAN EXAMPLE NO. 1  
 13 of 13

# TOPSOIL EXCAVATION EXAMPLES

## TOPSOIL EXAMPLE NO. 1: Sample Plan Sheet

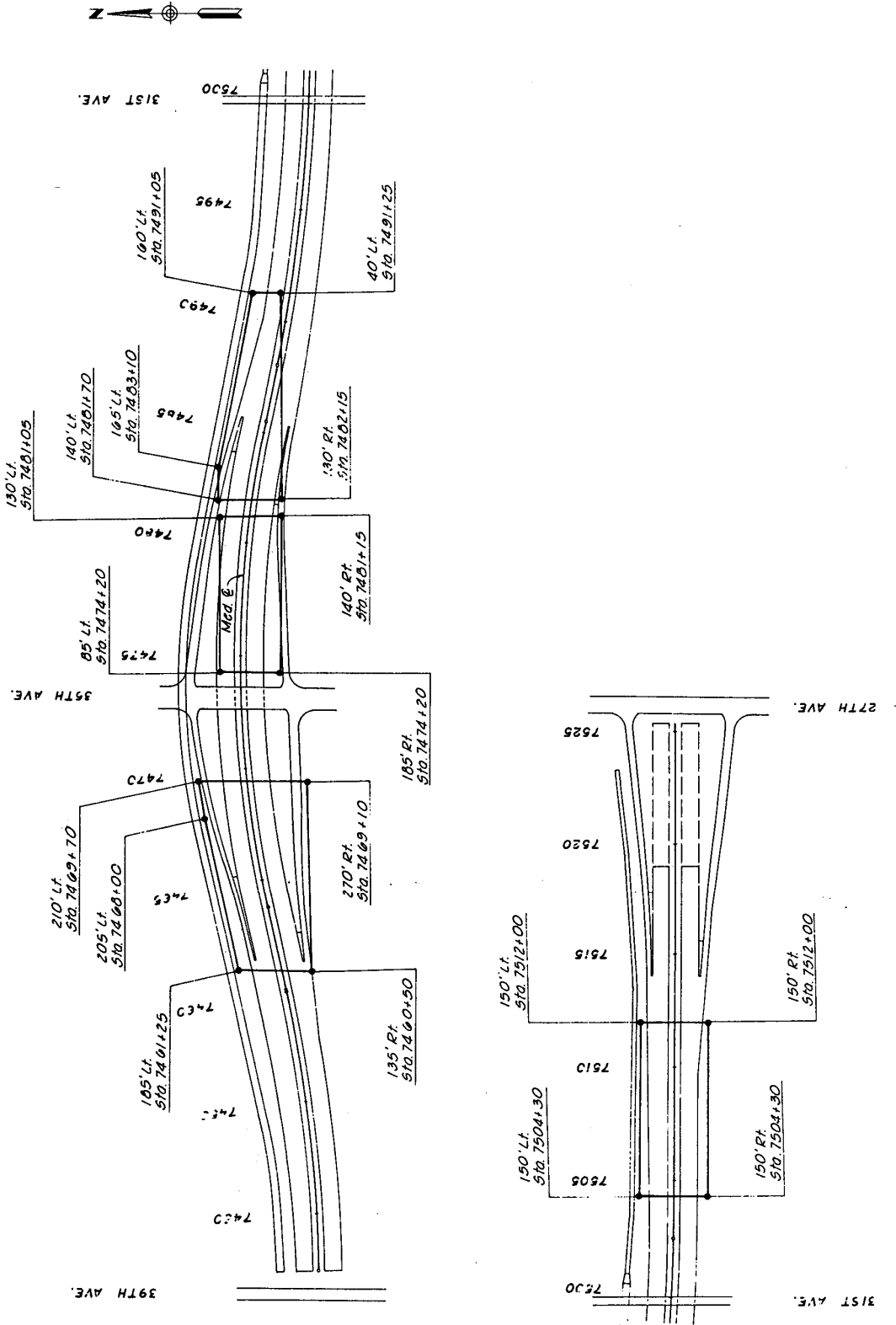

# TOPSOIL EXCAVATION EXAMPLES

## TOPSOIL EXAMPLE NO. 2: Topsoil Plating Diagram

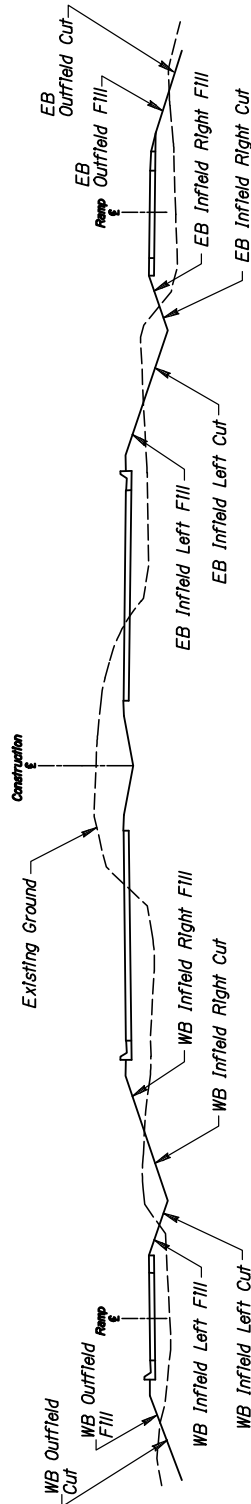

CONTOUR GRADING EXAMPLES

CONTOUR GRADING EXAMPLE NO. 1:

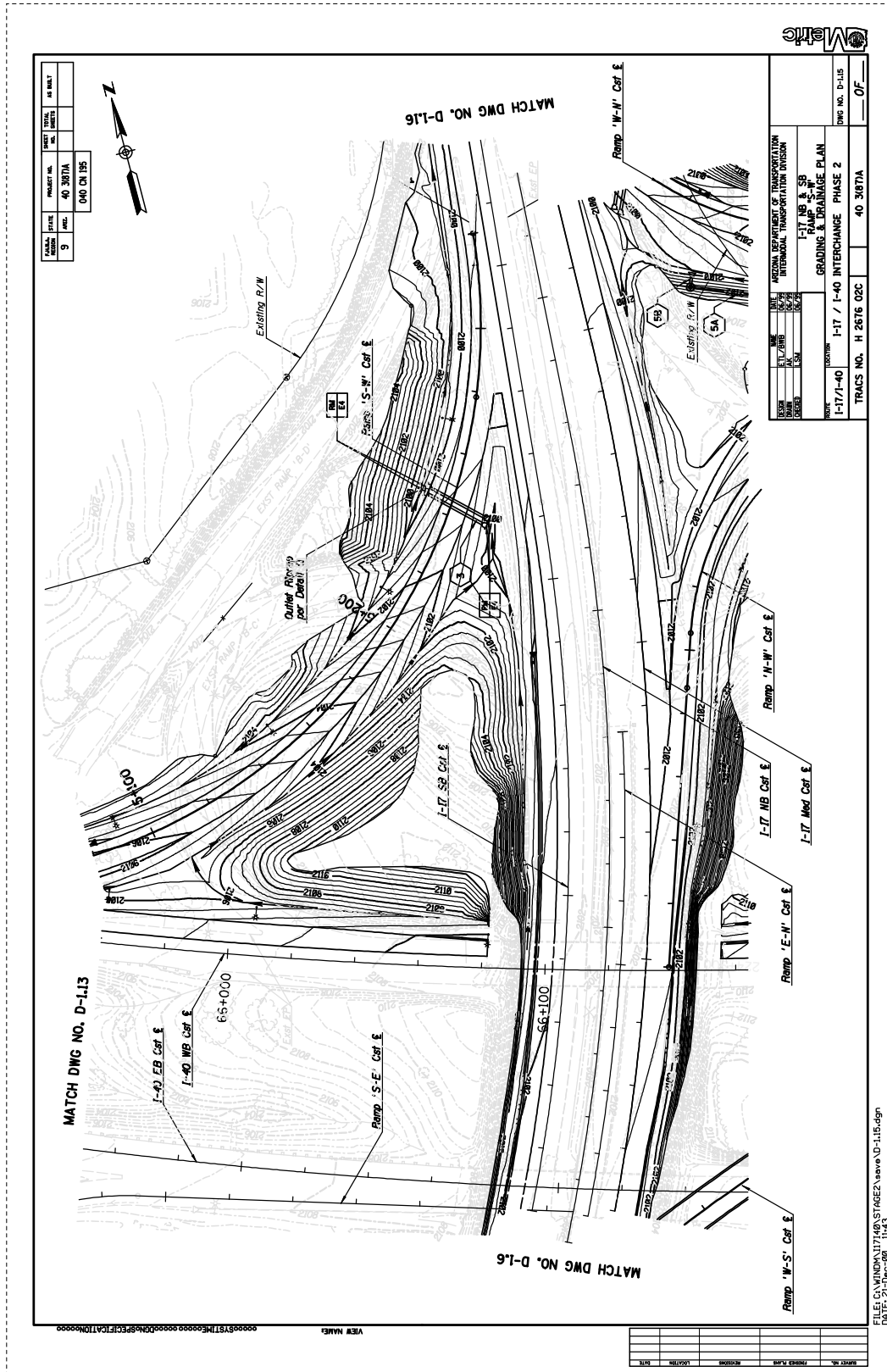

CONTOUR GRADING EXAMPLE NO. 1

CONTOUR GRADING EXAMPLES

CONTOUR GRADING EXAMPLE NO. 2:

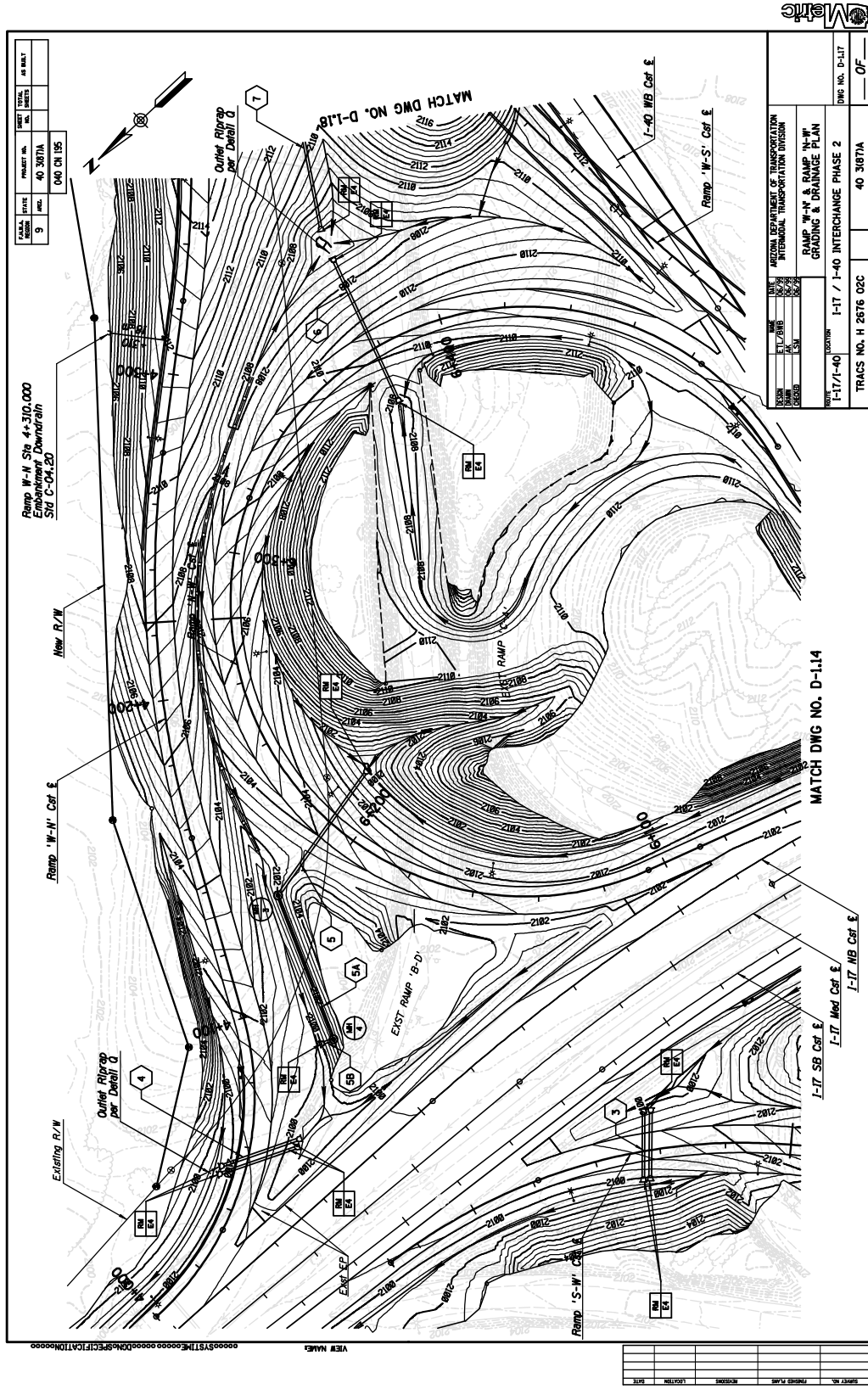





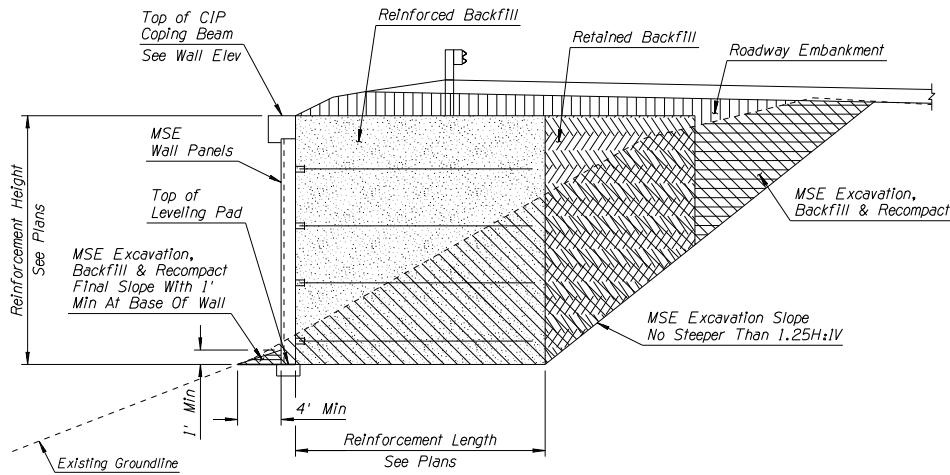



# MSE WALL EMBANKMENT ADJUSTMENT

## MSE WALL EXAMPLE NO. 1: Side Hill Location



TYPICAL SECTION  
N.T.S.

LEGEND:

-  MSE Excavation, Backfill & Recompact
-  Reinforced Backfill
-  MSE Excavation & Reinforced Backfill
-  Retained Backfill
-  MSE Excavation & Retained Backfill
-  Roadway Embankment
-  Embankment Adjustment In Area Of Reinforced Backfill
-  Embankment Adjustment In Area Of Retained Backfill

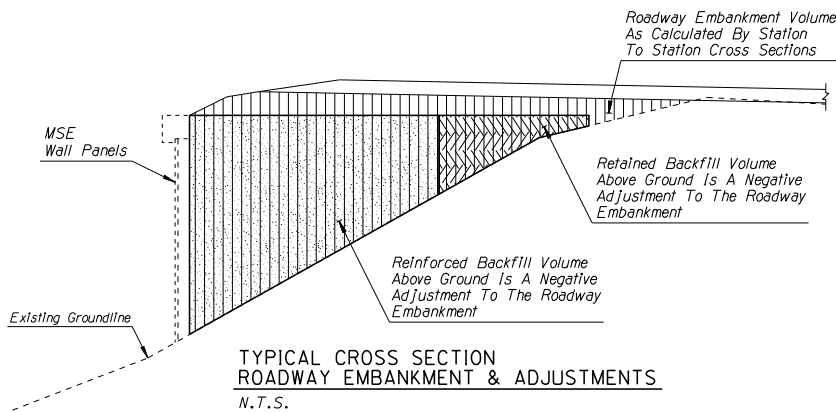

TYPICAL CROSS SECTION  
ROADWAY EMBANKMENT & ADJUSTMENTS  
N.T.S.

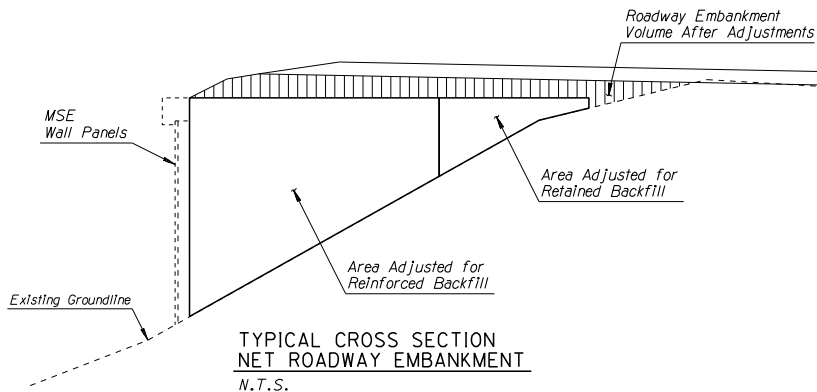

TYPICAL CROSS SECTION  
NET ROADWAY EMBANKMENT  
N.T.S.

NOTE:  
Embankment adjustment for Backfill (Reinforced & Retained) is typically made regardless of source of backfill material (within project or Imported). Cross section embankment area typically overlaps area of backfill.

# MSE WALL EMBANKMENT ADJUSTMENT

## MSE WALL EXAMPLE NO. 2: Bottom Of Leveling Pad In Cut

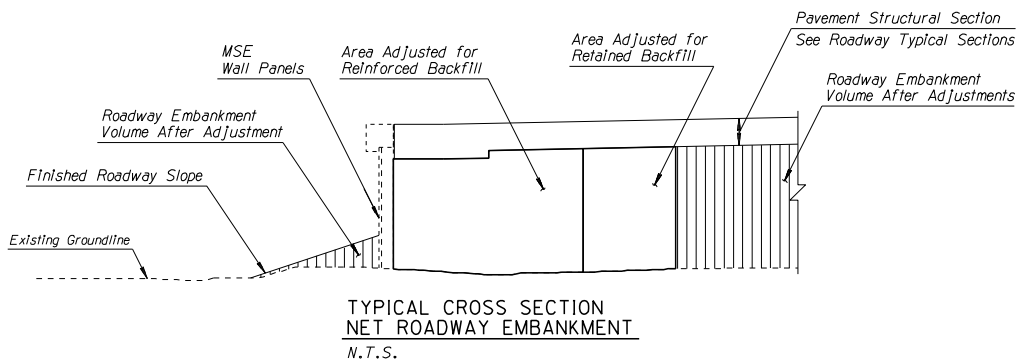
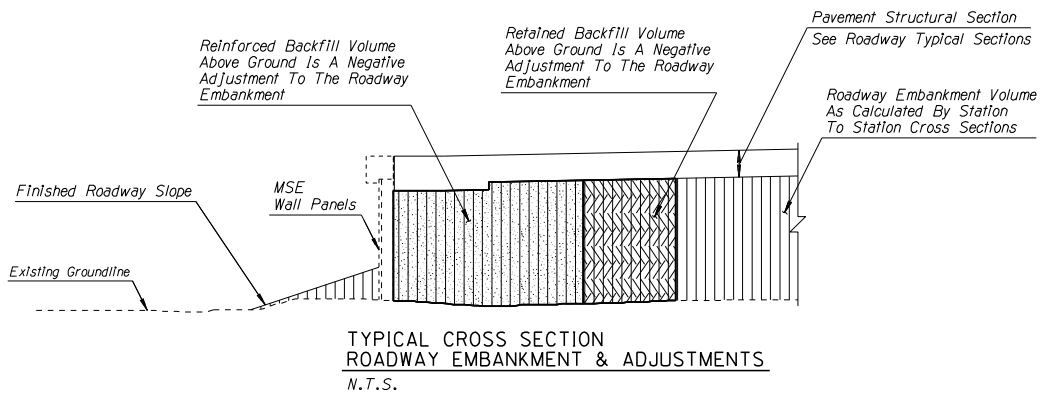
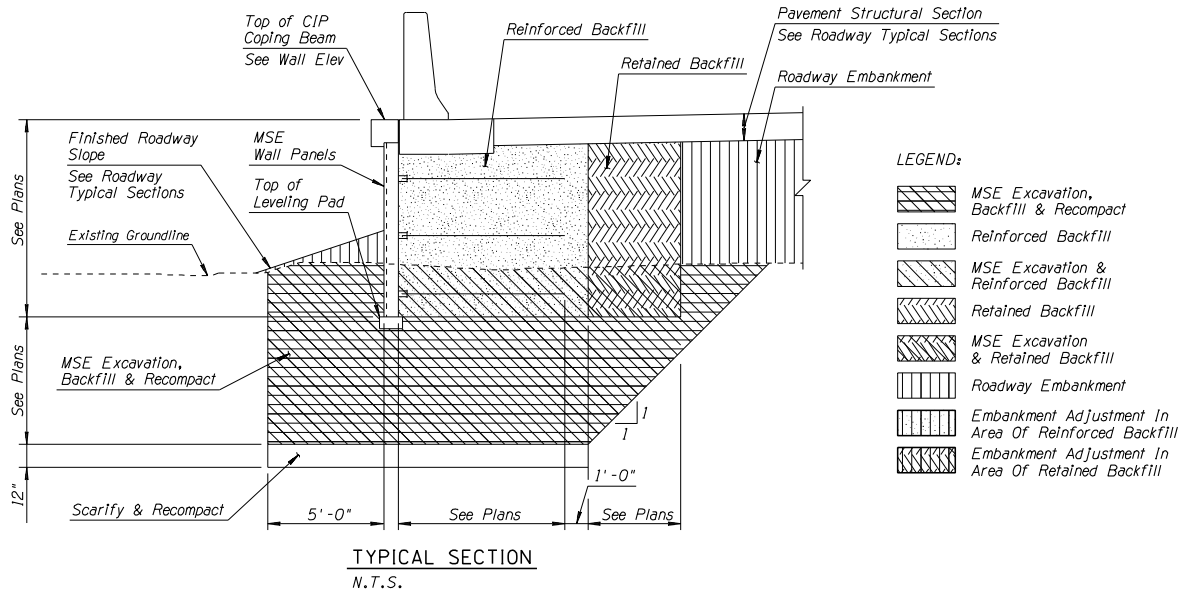

**NOTE:**  
Embankment adjustment for Backfill (Reinforced & Retained) is typically made regardless of source of backfill material (within project or imported). Cross section embankment area typically overlaps area of backfill.

# MSE WALL EMBANKMENT ADJUSTMENT

## MSE WALL EXAMPLE NO. 3: Bottom Of Leveling Pad In Fill

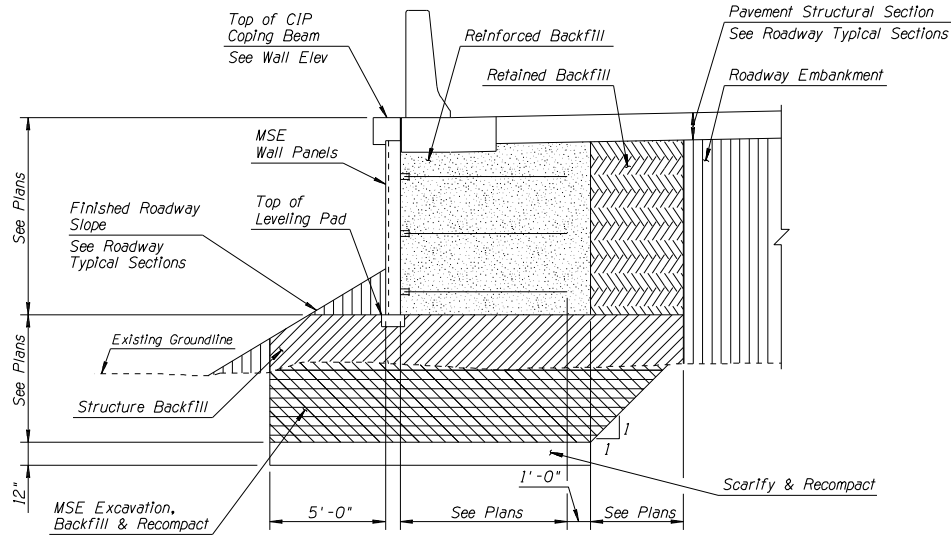

**LEGEND:**

- MSE Excavation, Backfill & Recompact
- Structure Backfill
- Reinforced Backfill
- Retained Backfill
- Roadway Embankment
- Embankment Adjustment In Area Of Reinforced Backfill
- Embankment Adjustment In Area Of Retained Backfill
- Embankment Adjustment In Area Of Structure Backfill

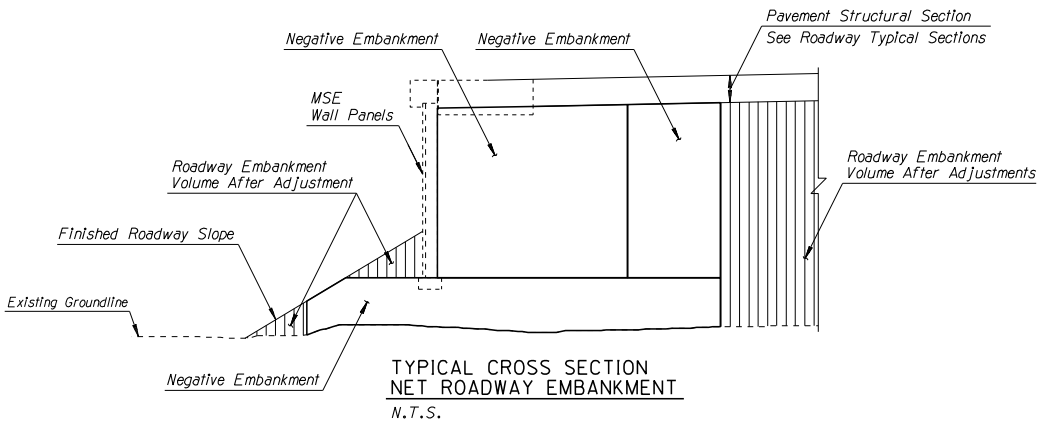
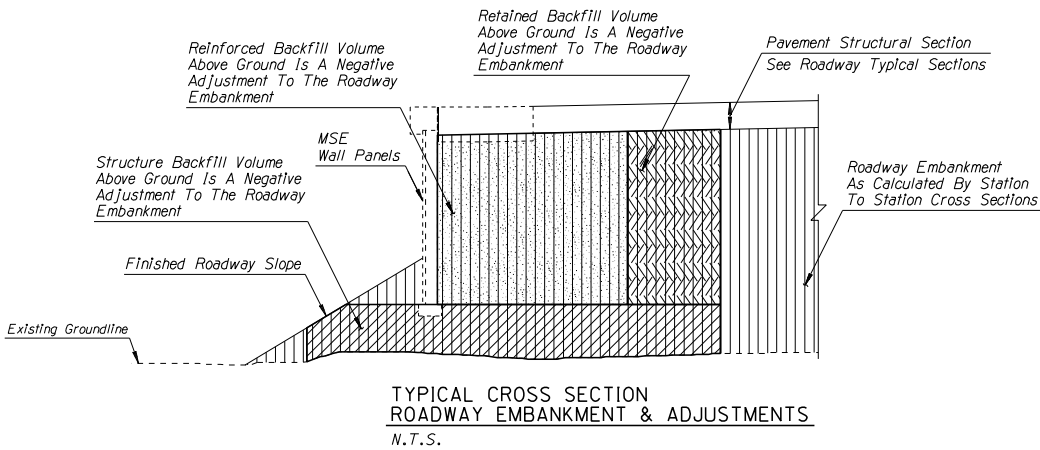

**NOTE:**  
Embankment adjustment for Backfill (Structure, Reinforced & Retained) is typically made regardless of source of backfill material (within project or Imported). Cross section embankment area typically overlaps area of Backfill.



**APPENDIX C**

**OPERATIONAL DRAINAGE FREQUENCY CLASS MAP**



**for**

**STATE HIGHWAYS**

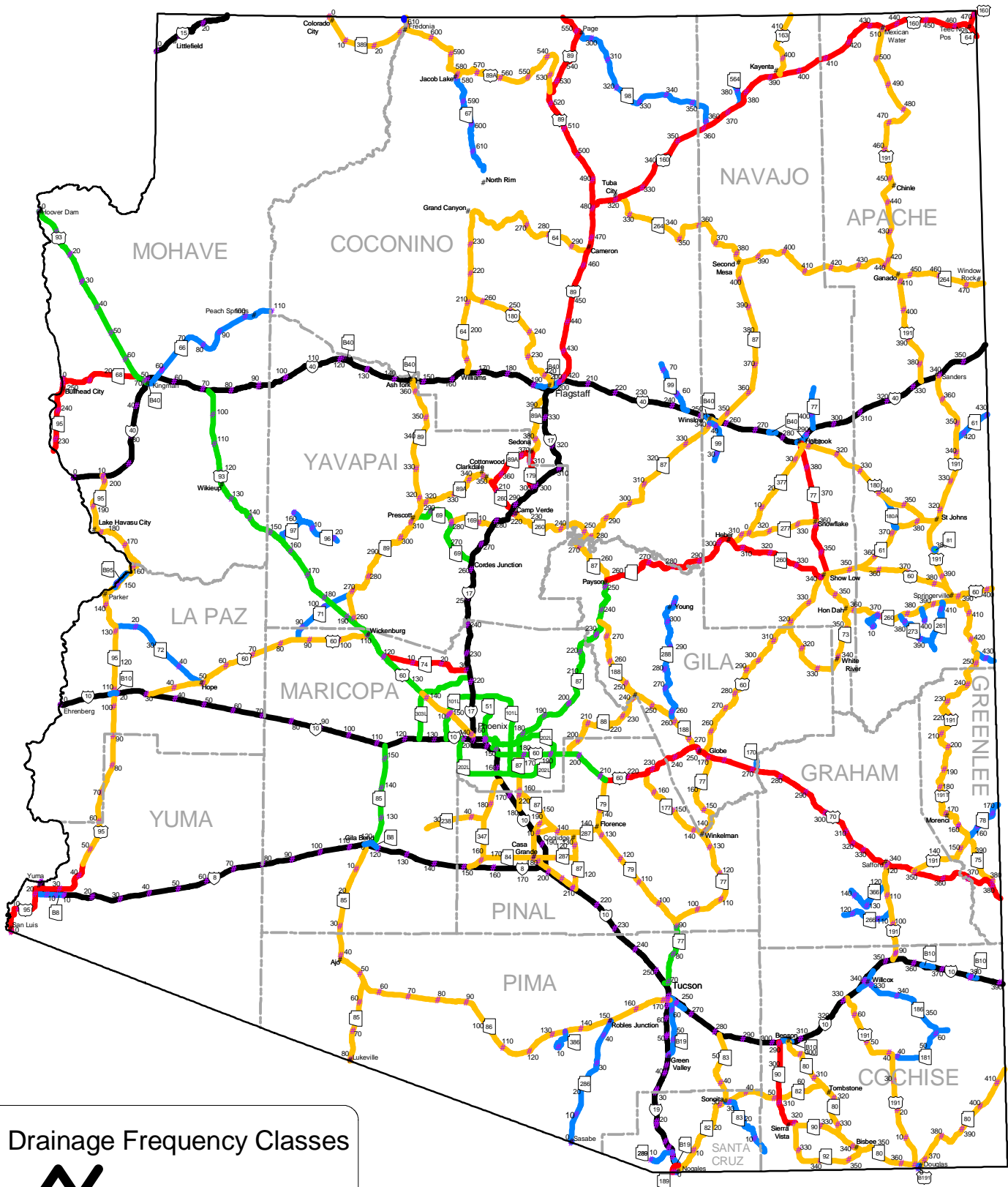
# Operational Drainage Frequency Classes



**Drainage Frequency Classes**

-  Class 1
-  Class 2
-  Class 3
-  Class 4

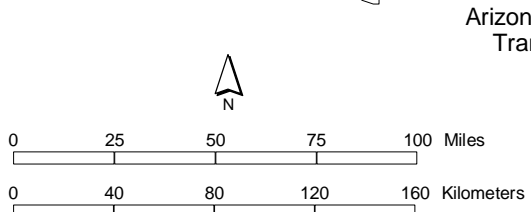

Arizona Department of Transportation  
 Transportation Planning Division  
 GIS Team

